

# CHARACTERISTIC CLASSES

BY

JOHN W. MILNOR

AND

JAMES D. STASHEFF

PRINCETON UNIVERSITY PRESS

AND

UNIVERSITY OF TOKYO PRESS

---

PRINCETON, NEW JERSEY

1974

Copyright © 1974 by Princeton University Press

ALL RIGHTS RESERVED

Published in Japan exclusively by  
University of Tokyo Press;  
in other parts of the world by  
Princeton University Press

Printed in the United States of America

Library of Congress Cataloging in Publication Data  
will be found on the last printed page of this book.

## Preface

The text which follows is based mostly on lectures at Princeton University in 1957. The senior author wishes to apologize for the delay in publication.

The theory of characteristic classes began in the year 1935 with almost simultaneous work by HASSLER WHITNEY in the United States and EDUARD STIEFEL in Switzerland. Stiefel's thesis, written under the direction of Heinz Hopf, introduced and studied certain "characteristic" homology classes determined by the tangent bundle of a smooth manifold. Whitney, then at Harvard University, treated the case of an arbitrary sphere bundle. Somewhat later he invented the language of cohomology theory, hence the concept of a characteristic cohomology class, and proved the basic product theorem.

In 1942 LEV PONTRJAGIN of Moscow University began to study the homology of Grassmann manifolds, using a cell subdivision due to Charles Ehresmann. This enabled him to construct important new characteristic classes. (Pontrjagin's many contributions to mathematics are the more remarkable in that he is totally blind, having lost his eyesight in an accident at the age of fourteen.)

In 1946 SHING-SHEN CHERN, recently arrived at the Institute for Advanced Study from Kunming in southwestern China, defined characteristic classes for complex vector bundles. In fact he showed that the complex Grassmann manifolds have a cohomology structure which is much easier to understand than that of the real Grassmann manifolds. This has led to a great clarification of the theory of real characteristic classes.

We are happy to report that the four original creators of characteristic class theory all remain mathematically active: *Whitney* at the Institute for Advanced Study in Princeton, *Stiefel* as director of the Institute for Applied Mathematics of the Federal Institute of Technology in Zürich, *Pontrjagin* as director of the Steklov Institute in Moscow, and *Chern* at the University of California in Berkeley. This book is dedicated to them.

JOHN MILNOR

JAMES STASHEFF

## Contents

Preface .....	v
§1. Smooth Manifolds .....	3
§2. Vector Bundles .....	13
§3. Constructing New Vector Bundles Out of Old .....	25
§4. Stiefel-Whitney Classes .....	37
§5. Grassmann Manifolds and Universal Bundles .....	55
§6. A Cell Structure for Grassmann Manifolds .....	73
§7. The Cohomology Ring $H^*(G_n; \mathbb{Z}/2)$ .....	83
§8. Existence of Stiefel-Whitney Classes .....	89
§9. Oriented Bundles and the Euler Class .....	95
§10. The Thom Isomorphism Theorem .....	105
§11. Computations in a Smooth Manifold .....	115
§12. Obstructions .....	139
§13. Complex Vector Bundles and Complex Manifolds .....	149
§14. Chern Classes .....	155
§15. Pontrjagin Classes .....	173
§16. Chern Numbers and Pontrjagin Numbers .....	183
§17. The Oriented Cobordism Ring $\Omega_*$ .....	199
§18. Thom Spaces and Transversality .....	205
§19. Multiplicative Sequences and the Signature Theorem .....	219
§20. Combinatorial Pontrjagin Classes .....	231
Epilogue .....	249
Appendix A: Singular Homology and Cohomology .....	257
Appendix B: Bernoulli Numbers .....	281
Appendix C: Connections, Curvature, and Characteristic Classes .....	289
Bibliography .....	315
Index .....	325

## Characteristic Classes

## §1. Smooth Manifolds

This section contains a brief introduction to the theory of smooth manifolds and their tangent spaces.

Let  $\mathbb{R}^n$  denote the coordinate space consisting of all  $n$ -tuples  $x = (x_1, \dots, x_n)$  of real numbers. For the special case  $n = 0$  it is to be understood that  $\mathbb{R}^0$  consists of a single point. The real number themselves will be denoted by  $\mathbb{R}$ .

The word "smooth" will be used as a synonym for "differentiable of class  $C^\infty$ ." Thus a function defined on an open set  $U \subset \mathbb{R}^n$  with values in  $\mathbb{R}^k$  is *smooth* if its partial derivatives of all orders exist and are continuous.

For some purposes it is convenient to use a coordinate space  $\mathbb{R}^A$  which may be infinite dimensional. Let  $A$  be any index set and let  $\mathbb{R}^A$  denote the vector space consisting of all functions\*  $x$  from  $A$  to  $\mathbb{R}$ . The value of a vector  $x \in \mathbb{R}^A$  on  $\alpha \in A$  will be denoted by  $x_\alpha$  and called the  $\alpha$ -th coordinate of  $x$ . Similarly, for any function  $f: Y \rightarrow \mathbb{R}^A$ , the  $\alpha$ -th coordinate of  $f(y)$  will be denoted by  $f_\alpha(y)$ .

We topologize this space  $\mathbb{R}^A$  as a cartesian product of copies of  $\mathbb{R}$ . For any subset  $M \subset \mathbb{R}^A$ , we give  $M$  the relative topology. Thus a function  $f: Y \rightarrow M \subset \mathbb{R}^A$  is continuous if and only if each of the associated functions  $f_\alpha: Y \rightarrow \mathbb{R}$  is continuous. Here  $Y$  can be an arbitrary topological space.

---

\* Of course our previous coordinate space  $\mathbb{R}^n$  can be obtained as a special case of this more general concept, simply by taking  $A$  to be the set of integers between 1 and  $n$ .

DEFINITION. For  $U \subset \mathbb{R}^n$ , a function  $f: U \rightarrow M \subset \mathbb{R}^A$  is said to be *smooth* if each of the associated functions  $f_\alpha: U \rightarrow \mathbb{R}$  is smooth. If  $f$  is smooth, then the partial derivative  $\partial f / \partial u_i$  can be defined as the smooth function  $U \rightarrow \mathbb{R}^A$  whose  $\alpha$ -th coordinate is  $\partial f_\alpha / \partial u_i$  for  $i = 1, \dots, n$ .

The most classical and familiar examples of smooth manifolds are curves and surfaces in the coordinate space  $\mathbb{R}^3$ . Generalizing the classical description of curves and surfaces, we will consider  $n$ -dimensional objects in a coordinate space  $\mathbb{R}^A$ .

DEFINITION. A subset  $M \subset \mathbb{R}^A$  is a *smooth manifold* of dimension  $n \geq 0$  if, for each  $x \in M$  there exists a smooth function

$$h: U \rightarrow \mathbb{R}^A$$

defined on an open set  $U \subset \mathbb{R}^n$  such that

1)  $h$  maps  $U$  homeomorphically onto an open neighborhood  $V$  of  $x$  in  $M$ , and

2) for each  $u \in U$  the matrix  $[\partial h_\alpha(u) / \partial u_j]$  has rank  $n$ . (In other words the  $n$  vectors  $\partial h / \partial u_1, \dots, \partial h / \partial u_n$ , evaluated at  $u$ , must be linearly independent.)

The image  $h(U) = V$  of such a mapping will be called a *coordinate neighborhood* in  $M$ , and the triple  $(U, V, h)$  will be called a *local parametrization\** of  $M$ .

LEMMA 1.1. Let  $(U, V, h)$  and  $(U', V', h')$  be two local parametrizations of  $M$  such that  $V \cap V'$  is non-vacuous. Then the correspondence

$$u' \mapsto h^{-1}(h'(u'))$$

defines a smooth mapping from the open set  $(h')^{-1}(V \cap V') \subset \mathbb{R}^n$  to the open set  $h^{-1}(V \cap V') \subset \mathbb{R}^n$ .

\* The inverse  $h^{-1}: V \rightarrow U \subset \mathbb{R}^n$  is often called a "local coordinate system" or "chart" for  $M$ .



*Proof.* Let  $\bar{x} = h(\bar{u}) = h'(\bar{u}')$  be an arbitrary point of  $V \cap V'$ . Choose indices  $\alpha_1, \dots, \alpha_n \in A$  so that the  $n \times n$  matrix  $[\partial h_{\alpha_i} / \partial u_j]$ , evaluated at  $\bar{u}$ , is non-singular. Then it follows from the inverse function theorem that one can solve for  $u_1, \dots, u_n$  as smooth functions

$$u_j = f_j(h_{\alpha_1}(u), \dots, h_{\alpha_n}(u))$$

for  $u$  in some neighborhood of  $\bar{u}$ . (See for example [Whitney, 1957, p. 69].) Writing these equations in vector notation as  $u = f(h_{\alpha_1}(u), \dots, h_{\alpha_n}(u))$ , and setting  $h(u) = h'(u')$ , it follows that the function

$$u' \mapsto h^{-1}h'(u') = f(h'_{\alpha_1}(u'), \dots, h'_{\alpha_n}(u'))$$

is smooth throughout some neighborhood of  $u'$ . This completes the proof. ■

The concept of tangent vector can be defined as follows. Let  $\bar{x}$  be a fixed point of  $M$ , and let  $(-\varepsilon, \varepsilon)$  denote the set of real numbers  $t$  with  $-\varepsilon < t < \varepsilon$ . A *smooth path* through  $\bar{x}$  in  $M$  will mean a smooth function

$$p: (-\varepsilon, \varepsilon) \rightarrow M \subset \mathbb{R}^A,$$

defined on some interval  $(-\varepsilon, \varepsilon)$  of real numbers, with  $p(0) = \bar{x}$ . The *velocity vector* of such a path is defined to be the vector

$$(dp/dt)|_{t=0} \in \mathbb{R}^A$$

whose  $\alpha$ -th component is  $dp_{\alpha}(0)/dt$ . (Compare Figure 1.)

**DEFINITION.** A vector  $v \in \mathbb{R}^A$  is *tangent* to  $M$  at  $x$  if  $v$  can be expressed as the velocity vector of some smooth path through  $x$  in  $M$ . The set of all such tangent vectors will be called the *tangent space* of  $M$  at  $x$ , and will be denoted by  $DM_x$ . (In some presentations, the vector  $v$  is identified with the collection of paths  $p$  with common velocity vector  $v$ . This allows an intrinsic definition of tangent vector independent of the embedding in  $\mathbb{R}^A$ .)

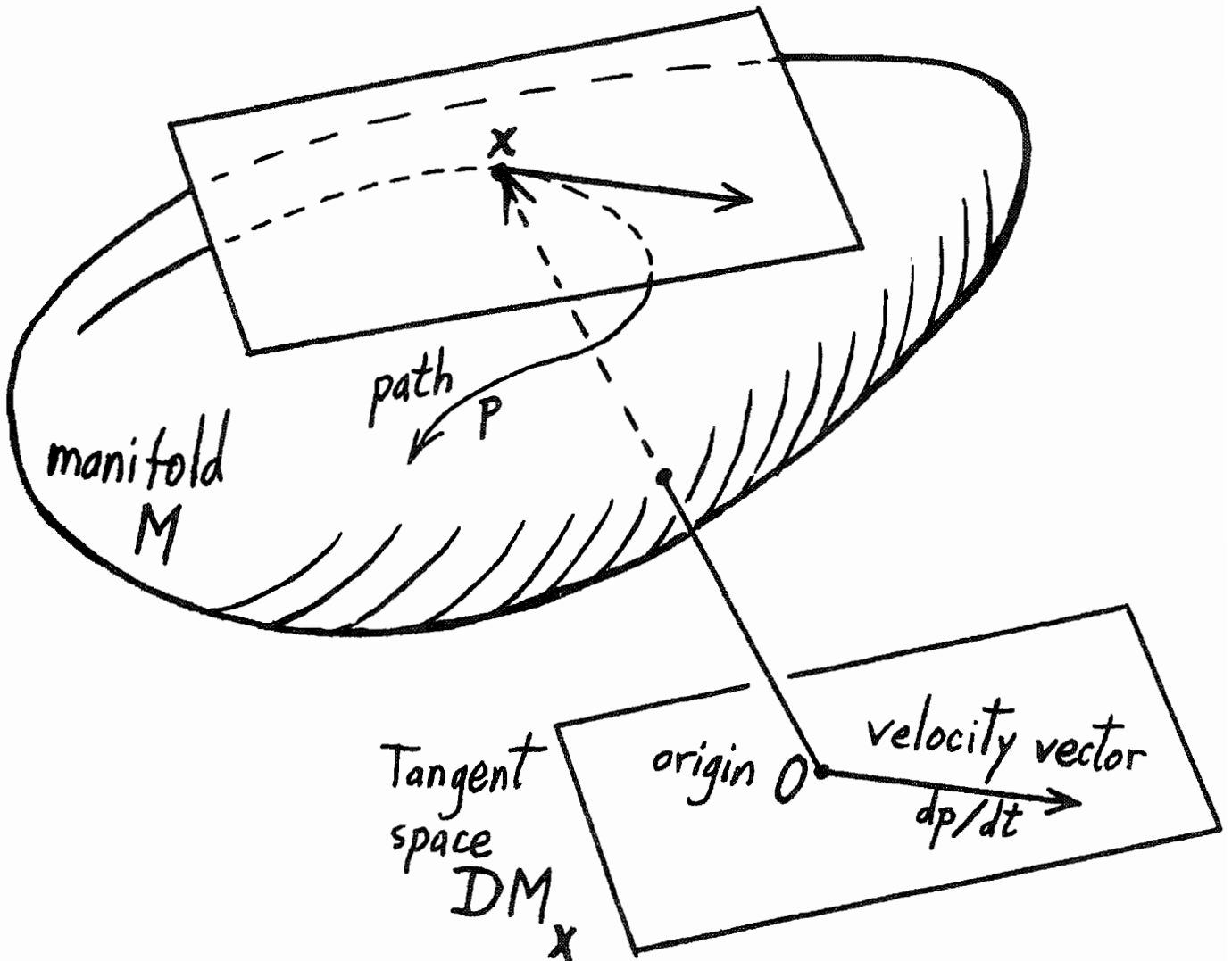

Figure 1.

In terms of a local parametrization  $(U, V, h)$  with  $h(\bar{u}) = \bar{x}$ , the tangent space can be described as follows.

LEMMA 1.2. A vector  $v \in \mathbb{R}^A$  is tangent to  $M$  at  $\bar{x}$  if and only if  $v$  can be expressed as a linear combination of the vectors

$$\frac{\partial h}{\partial u_1}(\bar{u}), \dots, \frac{\partial h}{\partial u_n}(\bar{u}).$$

Thus  $DM_{\bar{x}}$  is an  $n$ -dimensional vector space over the real numbers.

The proof is straightforward.

The *tangent manifold* of  $M$  is defined to be the subspace

$$DM \subset M \times \mathbb{R}^A$$

consisting of all pairs  $(x, v)$  with  $x \in M$  and  $v \in DM_x$ . It follows easily from Lemma 1.2 that  $DM$ , considered as a subset of  $\mathbb{R}^A \times \mathbb{R}^A$ , is a smooth manifold of dimension  $2n$ .

Now consider two smooth manifolds  $M \subset \mathbb{R}^A$  and  $N \subset \mathbb{R}^B$ , and a function  $f: M \rightarrow N$ . Let  $\bar{x}$  be a point of  $M$  and  $(U, V, h)$  a local parametrization of  $M$  with  $\bar{x} = h(\bar{u})$ .

DEFINITION. The function  $f$  is said to be smooth at  $\bar{x}$  if the composition\*

$$f \circ h: U \rightarrow N \subset \mathbb{R}^B$$

is smooth throughout some neighborhood of  $\bar{u}$ .

It follows from 1.1 that this definition does not depend on the choice of local parametrization.

DEFINITION. The function  $f: M \rightarrow N$  is *smooth* if it is smooth at  $x$  for every  $x \in M$ . A function  $f: M \rightarrow N$  is called a *diffeomorphism* if  $f$  is one-to-one onto, and if both  $f$  and the inverse function  $f^{-1}: N \rightarrow M$  are smooth.

LEMMA 1.3. *The identity map of  $M$  is always smooth. Furthermore the composition of two smooth maps  $M \xrightarrow{g} M' \xrightarrow{f} M''$  is smooth.*

---

\* The notation  $f \circ g$  will be used for the composition of two functions  $X \xrightarrow{g} Y \xrightarrow{f} Z$ .

The proof is similar to that of 1.1. Details will be omitted.

Any map  $f: M \rightarrow N$  which is smooth at  $x$  determines a linear map  $Df_x$  from the tangent space  $DM_x$  to  $DN_{f(x)}$  as follows. Given  $v \in DM_x$  express  $v$  as the velocity vector

$$v = (dp/dt)|_{t=0}$$

of some smooth path through  $x$  in  $M$ , and define  $Df_x(v)$  to be the velocity vector

$$(d(f \circ p)/dt)|_{t=0}$$

of the image path  $f \circ p: (-\varepsilon, \varepsilon) \rightarrow N$ . It is easily seen that this definition does not depend on the choice of  $p$ , and that  $Df_x$  is a linear mapping. In fact, in terms of a local parametrization  $(U, V, h)$ , one has the explicit formula

$$Df_x \left( \sum c_i \partial h / \partial u_i \right) = \sum c_i \partial (f \circ h) / \partial u_i ,$$

for any real numbers  $c_1, \dots, c_n$ .

**DEFINITION.** The linear transformation  $Df_x$  is called the *derivative*, or the *Jacobian* of  $f$  at  $x$ .

Now suppose that  $f: M \rightarrow N$  is smooth everywhere. Combining all of the Jacobians  $Df_x$  one obtains a function

$$Df: DM \rightarrow DN$$

where  $Df(x, v) = (f(x), Df_x(v))$ .

**LEMMA 1.4.**  $D$  is a functor\* from the category of smooth manifolds and smooth maps into itself.

---

\* For the concepts of category and functor, see for example [Eilenberg and Steenrod, Chapter IV].

In other words: (1) If  $M$  is a smooth manifold, then  $DM$  is a smooth manifold. (2) If  $f$  is a smooth map from  $M$  to  $N$  then  $Df$  is a smooth map from  $DM$  to  $DN$ . (3) If  $I$  is the identity map of  $M$  then  $DI$  is the identity map of  $DM$ ; and (4) if the composition  $f \circ g$  of two smooth maps is defined, then  $D(f \circ g) = (Df) \circ (Dg)$ . The proofs are straightforward.

One immediate consequence is the following: *If  $f$  is a diffeomorphism from  $M$  to  $N$  then  $Df$  is a diffeomorphism from  $DM$  to  $DN$ .*

REMARKS. According to our definitions, the tangent space  $DR_x^n$  of the coordinate space  $R^n$  at  $x$  is equal to the vector space  $R^n$  itself. In particular, for any real number  $u$  the tangent space  $DR_u$  is equal to  $R$ . Thus if  $f: M \rightarrow R$  is a smooth real valued function, then the derivative  $Df_x: DM_x \rightarrow DR_{f(x)} = R$  can be thought of as an element of the dual vector space

$$\text{Hom}_R(DM_x, R) .$$

This element  $Df_x$  of the dual space, sometimes called the “total differential” of  $f$  at  $x$ , is more commonly denoted by  $df(x)$ . Note that Leibniz’s rule is satisfied:

$$D(fg)_x = f(x)Dg_x + g(x)Df_x ,$$

where  $fg$  stands for the product function  $x \mapsto f(x)g(x)$ .

For any tangent vector  $v \in DM_x$  the real number  $Df_x(v)$  is called the *directional derivative* of the real valued function  $f$  at  $x$  in the direction  $v$ . If we keep  $(x, v)$  fixed but let  $f$  vary over the vector space  $C^\infty(M, R)$  consisting of all smooth real valued functions on  $M$ , then a linear differential operator

$$X: C^\infty(M, R) \rightarrow R$$

can be defined by the formula  $X(f) = Df_x(v)$ . Leibniz’s rule now takes the form

$$X(fg) = f(x)X(g) + X(f)g(x) .$$

In many expositions of the subject, the tangent vector  $(x, v)$  is identified with this linear operator  $X$ .

One defect of the above presentation is that the "smoothness" of a manifold  $M$  is made to depend on some particular embedding of  $M$  in a coordinate space. It is possible however to canonically embed any smooth manifold  $M$  in one preferred coordinate space.

Given a smooth manifold  $M \subset \mathbb{R}^A$  let  $F = C^\infty(M, \mathbb{R})$  denote the set of all smooth functions from  $M$  to the real numbers  $\mathbb{R}$ . Define the embedding

$$i: M \rightarrow \mathbb{R}^F$$

by  $i_f(x) = f(x)$ . Let  $M_1$  denote the image  $i(M) \subset \mathbb{R}^F$ .

LEMMA 1.5. *This image  $M_1$  is a smooth manifold in  $\mathbb{R}^F$ , and the canonical map  $i: M \rightarrow M_1$  is a diffeomorphism.*

The proof is straightforward.

Thus any smooth manifold has a canonical embedding in an associated coordinate space. This suggests the following definition.

Let  $M$  be a set and let  $F$  be a collection of real valued functions on  $M$  which separates points. (That is, given  $x \neq y$  in  $M$  there exists  $f \in F$  with  $f(x) \neq f(y)$ .) Then  $M$  can be identified with its image under the canonical imbedding  $i: M \rightarrow \mathbb{R}^F$ .

DEFINITION. The collection  $F$  is a *smoothness structure* on  $M$  if the subset  $i(M) \subset \mathbb{R}^F$  is a smooth manifold, and if  $F$  is precisely the set of all smooth real valued functions on this smooth manifold.\*

*Note:* This definition of "smoothness" is similar to that given by [Nomizu]. In the classical point of view the "smoothness structure" of a manifold is prescribed by the collection of local parametrizations. (See

---

\*

If only the first condition is satisfied, then  $F$  might be called a "basis" for a smoothness structure on  $M$ .

for example [Steenrod, 1951, p. 21].) In still another point of view, one uses collections of smooth functions on open subsets. (Compare [de Rham].) All of these definitions are equivalent.

In conclusion here are three problems for the reader. The first two of these will play an important role in later sections.

*Problem 1-A.* Let  $M_1 \subset \mathbb{R}^A$  and  $M_2 \subset \mathbb{R}^B$  be smooth manifolds. Show that  $M_1 \times M_2 \subset \mathbb{R}^A \times \mathbb{R}^B$  is a smooth manifold, and that the tangent manifold  $D(M_1 \times M_2)$  is canonically diffeomorphic to the product  $DM_1 \times DM_2$ . Note that a function  $x \mapsto (f_1(x), f_2(x))$  from  $M$  to  $M_1 \times M_2$  is smooth if and only if both  $f_1 : M \rightarrow M_1$  and  $f_2 : M \rightarrow M_2$  are smooth.

*Problem 1-B.* Let  $P^n$  denote the set of all lines through the origin in the coordinate space  $\mathbb{R}^{n+1}$ . Define a function

$$q : \mathbb{R}^{n+1} - \{0\} \rightarrow P^n$$

by  $q(x) = Rx =$  line through  $x$ . Let  $F$  denote the set of all functions  $f : P^n \rightarrow \mathbb{R}$  such that  $f \circ q$  is smooth.

a) Show that  $F$  is a smoothness structure on  $P^n$ . The resulting smooth manifold is called the *real projective space* of dimension  $n$ .

b) Show that the functions  $f_{ij}(Rx) = x_i x_j / \sum x_k^2$  define a diffeomorphism between  $P^n$  and the submanifold of  $\mathbb{R}^{(n+1)^2}$  consisting of all symmetric  $(n+1) \times (n+1)$  matrices  $A$  of trace 1 satisfying  $AA = A$ .

c) Show that  $P^n$  is compact, and that a subset  $V \subset P^n$  is open if and only if  $q^{-1}(V)$  is open.

*Problem 1-C.* For any smooth manifold  $M$  show that the collection  $F = C^\infty(M, \mathbb{R})$  of smooth real valued functions on  $M$  can be made into a ring, and that every point  $x \in M$  determines a ring homomorphism  $F \rightarrow \mathbb{R}$  and hence a maximal ideal in  $F$ . If  $M$  is compact, show that every maximal ideal in  $F$  arises in this way from a point of  $M$ . More generally, if there is a countable basis for the topology of  $M$ , show that every ring

homomorphism  $F \rightarrow \mathbb{R}$  is obtained in this way. (Make use of an element  $f \geq 0$  in  $F$  such that each  $f^{-1}[0, c]$  is compact.) Thus the smooth manifold  $M$  is completely determined by the ring  $F$ . For  $x \in M$ , show that any  $\mathbb{R}$ -linear mapping  $X: F \rightarrow \mathbb{R}$  satisfying  $X(fg) = X(f)g(x) + f(x)X(g)$  is given by  $X(f) = Df_x(v)$  for some uniquely determined vector  $v \in DM_x$ .



## §2. Vector Bundles

Let  $B$  denote a fixed topological space, which will be called the *base space*.

DEFINITION. A real vector bundle  $\xi$  over  $B$  consists of the following:

- 1) a topological space  $E = E(\xi)$  called the *total space*,
- 2) a (continuous) map  $\pi: E \rightarrow B$  called the *projection map*, and
- 3) for each  $b \in B$  the structure of a vector space\* over the real numbers in the set  $\pi^{-1}(b)$ .

These must satisfy the following restriction:

Condition of *local triviality*. For each point  $b$  of  $B$  there should exist a neighborhood  $U \subset B$ , an integer  $n \geq 0$ , and a homeomorphism

$$h: U \times \mathbb{R}^n \rightarrow \pi^{-1}(U)$$

so that, for each  $b \in U$ , the correspondence  $x \mapsto h(b, x)$  defines an isomorphism between the vector space  $\mathbb{R}^n$  and the vector space  $\pi^{-1}(b)$ .

Such a pair  $(U, h)$  will be called a *local coordinate system for  $\xi$  about  $b$* . If it is possible to choose  $U$  equal to the entire base space, then  $\xi$  will be called a *trivial bundle*.

The vector space  $\pi^{-1}(b)$  is called the *fiber* over  $b$ . It may be denoted by  $F_b$  or  $F_b(\xi)$ . Note that  $F_b$  is never vacuous, although it may consist of a single point. The dimension  $n$  of  $F_b$  is allowed to be a

---

\* To be more precise this vector space structure could be specified by giving the subset of  $\mathbb{R} \times \mathbb{R} \times E \times E \times E$  consisting of all 5-tuples  $(t_1, t_2, e_1, e_2, e_3)$  with

$$\pi(e_1) = \pi(e_2) = \pi(e_3) \quad \text{and} \quad e_3 = t_1 e_1 + t_2 e_2 .$$

(locally constant) function of  $b$ ; but in most cases of interest this function is constant. One then speaks of an  $n$ -plane bundle, or briefly an  $R^n$ -bundle.

The concept of a *smooth vector bundle* can be defined similarly. One requires that  $B$  and  $E$  be smooth manifolds, that  $\pi$  be a smooth map, and that, for each  $b \in B$  there exist a local coordinate system  $(U, h)$  with  $b \in U$  such that  $h$  is a diffeomorphism.

REMARK. An  $R^n$ -bundle is a very special example of a fiber bundle. (See [Steenrod, 1951, p. 9].) In Steenrod's terminology an  $R^n$ -bundle is a fiber bundle with fiber  $R^n$  and with the full linear group  $GL_n(R)$  in  $n$  variables as structural group.

Now consider two vector bundles  $\xi$  and  $\eta$  over the same base space  $B$ .

DEFINITION.  $\xi$  is *isomorphic* to  $\eta$ , written  $\xi \cong \eta$ , if there exists a homeomorphism

$$f: E(\xi) \rightarrow E(\eta)$$

between the total spaces which maps each vector space  $F_b(\xi)$  isomorphically onto the corresponding vector space  $F_b(\eta)$ .

*Example 1.* The trivial bundle with total space  $B \times R^n$ , with projection map  $\pi(b, x) = b$ , and with the vector space structures in the fibers defined by

$$t_1(b, x_1) + t_2(b, x_2) = (b, t_1 x_1 + t_2 x_2),$$

will be denoted by  $\varepsilon_B^n$ . Note that a second  $R^n$ -bundle over  $B$  is trivial if and only if it is isomorphic to  $\varepsilon_B^n$ .

*Example 2.* The *tangent bundle*  $\tau_M$  of a smooth manifold  $M$ . The total space of  $\tau_M$  is the manifold  $DM$  consisting of all pairs  $(x, v)$  with  $x \in M$  and  $v$  tangent to  $M$  at  $x$ . The projection map

$$\pi: DM \rightarrow M$$

is defined by  $\pi(x, v) = x$ ; and the vector space structure in  $\pi^{-1}(x)$  is defined by

$$t_1(x, v_1) + t_2(x, v_2) = (x, t_1 v_1 + t_2 v_2).$$

The local triviality condition is not difficult to verify. Note that  $\tau_M$  is an example of a smooth vector bundle.

If  $\tau_M$  is a trivial bundle, then the manifold  $M$  is called *parallelizable*. For example suppose that  $M$  is an open subset of  $\mathbb{R}^n$ . Then  $DM$  is equal to  $M \times \mathbb{R}^n$ , and  $M$  is clearly parallelizable.

The unit 2-sphere  $S^2 \subset \mathbb{R}^3$  provides an example of a manifold which is not parallelizable. (Compare Problem 2-B.) In fact we will see in §9 that a parallelizable manifold must have Euler characteristic zero, whereas the 2-sphere has Euler characteristic +2. (See Corollary 9.3 and Theorem 11.6.)

*Example 3.* The *normal bundle*  $\nu$  of a smooth manifold  $M \subset \mathbb{R}^n$  is obtained as follows. The total space

$$E \subset M \times \mathbb{R}^n$$

is the set of all pairs  $(x, v)$  such that  $v$  is orthogonal to the tangent space  $DM_x$ . The projection map  $\pi: E \rightarrow M$  and the vector space structure in  $\pi^{-1}(x)$  are defined, as in Examples 1, 2, by the formulas  $\pi(x, v) = x$ , and  $t_1(x, v_1) + t_2(x, v_2) = (x, t_1 v_1 + t_2 v_2)$ . The proof that  $\nu$  satisfies the local triviality condition will be deferred until §3.4.

*Example 4.* The *real projective space*  $P^n$  can be defined\* as the set of all unordered pairs  $\{x, -x\}$  where  $x$  ranges over the unit sphere  $S^n \subset \mathbb{R}^{n+1}$ ; and is topologized as a quotient space of  $S^n$ .

---

\* Alternatively  $P^n$  can be defined as the set of lines through the origin in  $\mathbb{R}^{n+1}$ . (Compare Problem 1-B.) This amounts to the same thing since every such line cuts  $S^n$  in two antipodal points.

Let  $E(\gamma_n^1)$  be the subset of  $P^n \times R^{n+1}$  consisting of all pairs  $(\{\pm x\}, v)$  such that the vector  $v$  is a multiple of  $x$ . Define  $\pi: E(\gamma_n^1) \rightarrow P^n$  by  $\pi(\{\pm x\}, v) = \{\pm x\}$ . Thus each fiber  $\pi^{-1}(\{\pm x\})$  can be identified with the line through  $x$  and  $-x$  in  $R^{n+1}$ . Each such line is to be given its usual vector space structure. The resulting vector bundle  $\gamma_n^1$  will be called the *canonical line bundle* over  $P^n$ .

*Proof that  $\gamma_n^1$  is locally trivial.* Let  $U \subset S^n$  be any open set which is small enough so as to contain no pair of antipodal points, and let  $U_1$  denote the image of  $U$  in  $P^n$ . Then a homeomorphism

$$h: U_1 \times R \rightarrow \pi^{-1}(U_1)$$

is defined by the requirement that

$$h(\{\pm x\}, t) = (\{\pm x\}, tx)$$

for each  $(x, t) \in U \times R$ . Evidently  $(U_1, h)$  is a local coordinate system; hence  $\gamma_n^1$  is locally trivial.

**THEOREM 2.1.** *The bundle  $\gamma_n^1$  over  $P^n$  is not trivial, for  $n \geq 1$ .*

This will be proved by studying cross-sections of  $\gamma_n^1$ .

**DEFINITION.** A *cross-section* of a vector bundle  $\xi$  with base space  $B$  is a continuous function

$$s: B \rightarrow E(\xi)$$

which takes each  $b \in B$  into the corresponding fiber  $F_b(\xi)$ . Such a cross-section is *nowhere zero* if  $s(b)$  is a non-zero vector of  $F_b(\xi)$  for each  $b$ .

(A cross-section of the tangent bundle of a smooth manifold  $M$  is usually called a *vector field* on  $M$ .)

Evidently a trivial  $R^1$ -bundle possesses a cross-section which is nowhere zero. We will see that the bundle  $\gamma_n^1$  has no such cross-section.

Let

$$s : P^n \rightarrow E(\gamma_n^1)$$

be any cross-section, and consider the composition

$$S^n \longrightarrow P^n \xrightarrow{s} E(\gamma_n^1)$$

which carries each  $x \in S^n$  to some pair

$$(\{\pm x\}, t(x)x) \in E(\gamma_n^1).$$

Evidently  $t(x)$  is a continuous real valued function of  $x$ , and

$$t(-x) = -t(x).$$

Since  $S^n$  is connected it follows from the intermediate value theorem that  $t(x_0) = 0$  for some  $x_0$ . Hence  $s(\{\pm x_0\}) = (\{\pm x_0\}, 0)$ . This completes the proof. ■

It is interesting to take a closer look at the space  $E(\gamma_n^1)$  for the special case  $n = 1$ . In this case each point  $e = (\{\pm x\}, v)$  of  $E(\gamma_1^1)$  can be written as

$$e = (\{\pm(\cos \theta, \sin \theta)\}, t(\cos \theta, \sin \theta))$$

with  $0 \leq \theta \leq \pi$ ,  $t \in \mathbb{R}$ . This representation is unique except that the point  $(\{\pm(\cos 0, \sin 0)\}, t(\cos 0, \sin 0))$  is equal to  $(\{\pm(\cos \pi, \sin \pi)\}, -t(\cos \pi, \sin \pi))$  for each  $t$ . In other words  $E(\gamma_1^1)$  can be obtained from the strip  $[0, \pi] \times \mathbb{R}$  in the  $(\theta, t)$ -plane by identifying the left hand boundary  $[0] \times \mathbb{R}$  with the right hand boundary  $[\pi] \times \mathbb{R}$  under the correspondence  $(0, t) \mapsto (\pi, -t)$ . Thus  $E(\gamma_1^1)$  is an open Moebius band. (Compare Figure 2.)

This description gives an alternative proof that  $\gamma_1^1$  is non-trivial. For the Moebius band is certainly not homeomorphic to the cylinder  $P^1 \times \mathbb{R}$ .

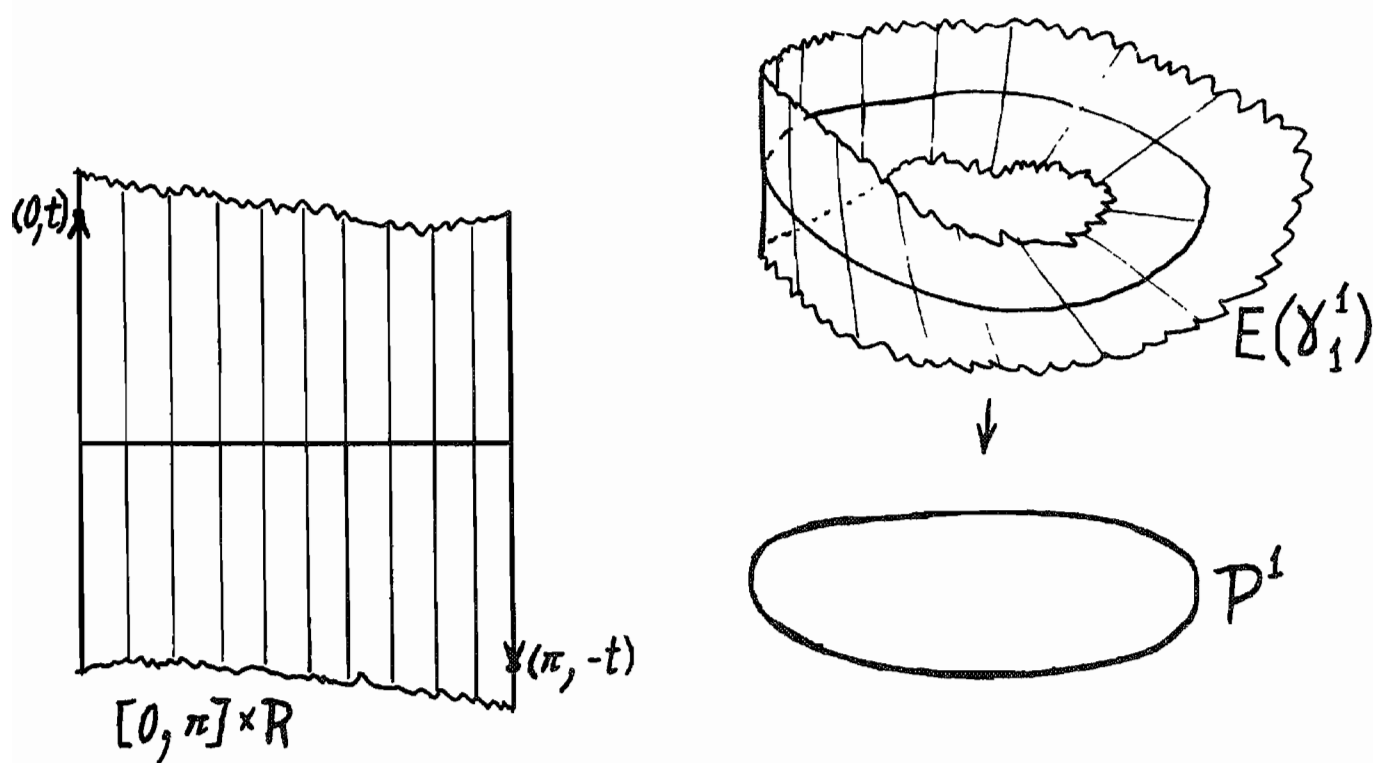

Figure 2.

Now consider a collection  $\{s_1, \dots, s_n\}$  of cross-sections of a vector bundle  $\xi$ .

**DEFINITION.** The cross-sections  $s_1, \dots, s_n$  are *nowhere dependent* if, for each  $b \in B$ , the vectors  $s_1(b), \dots, s_n(b)$  are linearly independent.

**THEOREM 2.2.** An  $\mathbb{R}^n$ -bundle  $\xi$  is trivial if and only if  $\xi$  admits  $n$  cross-sections  $s_1, \dots, s_n$  which are nowhere dependent.

The proof will depend on the following basic result.

**LEMMA 2.3.** Let  $\xi$  and  $\eta$  be vector bundles over  $B$  and let  $f: E(\xi) \rightarrow E(\eta)$  be a continuous function which maps each vector space  $F_b(\xi)$  isomorphically onto the corresponding vector space  $F_b(\eta)$ . Then  $f$  is necessarily a homeomorphism. Hence  $\xi$  is isomorphic to  $\eta$ .

*Proof.* Given any point  $b_0 \in B$ , choose local coordinate systems  $(U, g)$  for  $\xi$  and  $(V, h)$  for  $\eta$ , with  $b_0 \in U \cap V$ . Then we must show that the composition

$$(U \cap V) \times \mathbb{R}^n \xrightarrow{h^{-1} \circ f \circ g} (U \cap V) \times \mathbb{R}^n$$

is a homeomorphism. Setting

$$h^{-1}(f(g(b, x))) = (b, y)$$

it is evident that  $y = (y_1, \dots, y_n)$  can be expressed in the form

$$y_i = \sum_j f_{ij}(b) x_j$$

where  $[f_{ij}(b)]$  denotes a non-singular matrix of real numbers. Furthermore the entries  $f_{ij}(b)$  depend continuously on  $b$ . Let  $[F_{ji}(b)]$  denote the inverse matrix. Evidently

$$g^{-1} \circ f^{-1} \circ h(b, y) = (b, x)$$

where

$$x_j = \sum_i F_{ji}(b) y_i .$$

Since the numbers  $F_{ji}(b)$  depend continuously on the matrix  $[f_{ij}(b)]$ , they depend continuously on  $b$ . Thus  $g^{-1} \circ f^{-1} \circ h$  is continuous, which completes the proof of 2.3. ■

*Proof of Theorem 2.2.* Let  $s_1, \dots, s_n$  be cross-sections of  $\xi$  which are nowhere linearly dependent. Define

$$f: B \times \mathbb{R}^n \rightarrow E$$

by

$$f(b, x) = x_1 s_1(b) + \dots + x_n s_n(b) .$$

Evidently  $f$  is continuous and maps each fiber of the trivial bundle  $\varepsilon_B^n$  isomorphically onto the corresponding fiber of  $\xi$ . Hence  $f$  is a bundle isomorphism, and  $\xi$  is trivial.

Conversely suppose that  $\xi$  is trivial, with coordinate system  $(B, h)$ . Defining

$$s_i(b) = h(b, (0, \dots, 0, 1, 0, \dots, 0)) \in F_b(\xi)$$

(with the 1 in the  $i$ -th place), it is evident that  $s_1, \dots, s_n$  are nowhere dependent cross-sections. This completes the proof. ■

As an illustration, the tangent bundle of the circle  $S^1 \subset \mathbb{R}^2$  admits one nowhere zero cross-section, as illustrated in Figure 3. (The indicated arrows lead from  $x \in S^1$  to  $x + v$ , where  $s(x) = (x, v) = ((x_1, x_2), (-x_2, x_1))$ .) Hence  $S^1$  is parallelizable. Similarly the 3-sphere  $S^3 \subset \mathbb{R}^4$  admits three nowhere dependent vector fields  $s_i(x) = (x, \bar{s}_i(x))$  where

$$\bar{s}_1(x) = (-x_2, x_1, -x_4, x_3)$$

$$\bar{s}_2(x) = (-x_3, x_4, x_1, -x_2)$$

$$\bar{s}_3(x) = (-x_4, -x_3, x_2, x_1).$$

Hence  $S^3$  is parallelizable. (These formulas come from the quaternion multiplication in  $\mathbb{R}^4$ . Compare [Steenrod, 1951, §8.5].)

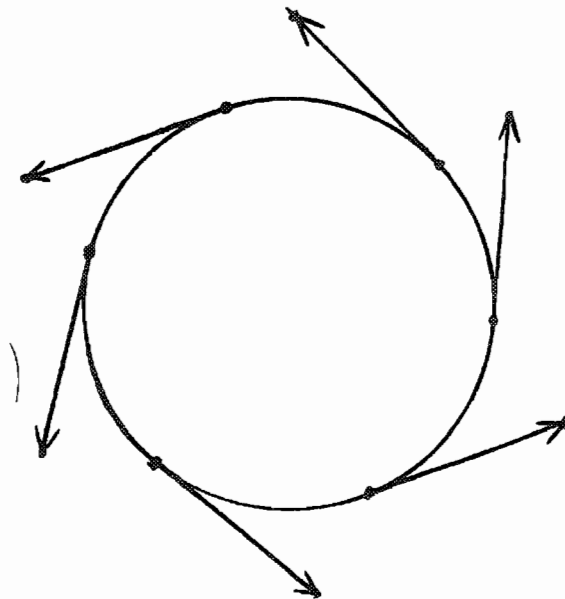

Figure 3.



### Euclidean Vector Bundles

For many purposes it is important to study vector bundles in which each fiber has the structure of a Euclidean vector space.

Recall that a real valued function  $\mu$  on a finite dimensional vector space  $V$  is *quadratic* if  $\mu$  can be expressed in the form

$$\mu(v) = \sum \ell_i(v) \ell'_i(v)$$

where each  $\ell_i$  and each  $\ell'_i$  is linear. Each quadratic function determines a symmetric and bilinear pairing  $v, w \mapsto v \cdot w$  from  $V \times V$  to  $\mathbb{R}$ , where

$$v \cdot w = \frac{1}{2}(\mu(v+w) - \mu(v) - \mu(w)) .$$

Note that  $v \cdot v = \mu(v)$ . The quadratic function  $\mu$  is called *positive definite* if  $\mu(v) > 0$  for  $v \neq 0$ .

**DEFINITION.** A *Euclidean vector space* is a real vector space  $V$  together with a positive definite quadratic function

$$\mu: V \rightarrow \mathbb{R} .$$

The real number  $v \cdot w$  will be called the *inner product* of the vectors  $v$  and  $w$ . The number  $v \cdot v = \mu(v)$  may also be denoted by  $|v|^2$ .

**DEFINITION.** A *Euclidean vector bundle* is a real vector bundle  $\xi$  together with a continuous function

$$\mu: E(\xi) \rightarrow \mathbb{R}$$

such that the restriction of  $\mu$  to each fiber of  $\xi$  is positive definite and quadratic. The function  $\mu$  itself will be called a *Euclidean metric* on the vector bundle  $\xi$ .

In the case of the tangent bundle  $\tau_M$  of a smooth manifold, a Euclidean metric

$$\mu: DM \rightarrow \mathbb{R}$$

is called a *Riemannian metric*, and  $M$  together with  $\mu$  is called a *Riemannian manifold*. (In practice one usually requires that  $\mu$  be a smooth function. The notation  $\mu = ds^2$  is often used for a Riemannian metric.)

*Note.* In Steenrod's terminology a Euclidean metric on  $\xi$  gives rise to a reduction of the structural group of  $\xi$  from the full linear group to the orthogonal group. Compare [Steenrod, 1951, §12.9].

*Examples.* The trivial bundle  $\varepsilon_B^n$  can be given the Euclidean metric

$$\mu(b, x) = x_1^2 + \dots + x_n^2.$$

Since the tangent bundle of  $\mathbb{R}^n$  is trivial it follows that the smooth manifold  $\mathbb{R}^n$  possesses a standard Riemannian metric. For any smooth manifold  $M \subset \mathbb{R}^n$  the composition

$$DM \subset D\mathbb{R}^n \xrightarrow{\mu} \mathbb{R}$$

now makes  $M$  into a Riemannian manifold.

A priori there appear to be two different concepts of triviality for Euclidean vector bundles; however the next lemma shows that these coincide.

**LEMMA 2.4.** *Let  $\xi$  be a trivial vector bundle of dimension  $n$  over  $B$ , and let  $\mu$  be any Euclidean metric on  $\xi$ . Then there exist  $n$  cross-sections  $s_1, \dots, s_n$  of  $\xi$  which are normal and orthogonal in the sense that*

$$s_i(b) \cdot s_j(b) = \delta_{ij} \quad (= \text{Kronecker delta})$$

for each  $b \in B$ .

Thus  $\xi$  is trivial also as a Euclidean vector bundle. (Compare Problem 2-E below.)

*Proof.* Let  $s'_1, \dots, s'_n$  be any  $n$  cross-sections which are nowhere linearly dependent. Applying the Gram-Schmidt\* process to  $s'_1(b), \dots, s'_n(b)$  we obtain a normal orthogonal basis  $s_1(b), \dots, s_n(b)$  for  $F_b(\xi)$ . Since the resulting functions  $s_1, \dots, s_n$  are clearly continuous, this completes the proof. ■

Here are six problems for the reader.

*Problem 2-A.* Show that the unit sphere  $S^n$  admits a vector field which is nowhere zero, providing that  $n$  is odd. Show that the normal bundle of  $S^n \subset \mathbb{R}^{n+1}$  is trivial for all  $n$ .

*Problem 2-B.* If  $S^n$  admits a vector field which is nowhere zero, show that the identity map of  $S^n$  is homotopic to the antipodal map. For  $n$  even show that the antipodal map of  $S^n$  is homotopic to the reflection

$$r(x_1, \dots, x_{n+1}) = (-x_1, x_2, \dots, x_{n+1});$$

and therefore has degree  $-1$ . (Compare [Eilenberg and Steenrod, p. 304].) Combining these facts, show that  $S^n$  is not parallelizable for  $n$  even,  $n \geq 2$ .

*Problem 2-C. Existence theorem for Euclidean metrics.* Using a partition of unity, show that any vector bundle over a paracompact base space can be given a Euclidean metric. (See §5.8; or see [Kelley, pp. 156 and 171].)

*Problem 2-D.* The Alexandroff line  $L$  (sometimes called the “long line”) is smooth, connected, 1-dimensional manifold which is not paracompact. (Reference: [Kneser].) Show that  $L$  cannot be given a Riemannian metric.

---

\* See any text book on linear algebra.

*Problem 2-E. Isometry theorem.* Let  $\mu$  and  $\mu'$  be two different Euclidean metrics on the same vector bundle  $\xi$ . Prove that there exists a homeomorphism  $f: E(\xi) \rightarrow E(\xi)$  which carries each fiber isomorphically onto itself, so that the composition  $\mu \circ f: E(\xi) \rightarrow \mathbf{R}$  is equal to  $\mu'$ . [Hint: Use the fact that every positive definite matrix  $A$  can be expressed uniquely as the square of a positive definite matrix  $\sqrt{A}$ . The power series expansion

$$\sqrt{(tI + X)} = \sqrt{t} \left( I + \frac{1}{2t} X - \frac{1}{8t^2} X^2 + \dots \right),$$

is valid providing that the characteristic roots of  $tI + X = A$  lie between 0 and  $2t$ . This shows that the function  $A \mapsto \sqrt{A}$  is smooth.]

*Problem 2-F.* As in Problem 1-C, let  $F$  denote the algebra of smooth real valued functions on  $M$ . For each  $x \in M$  let  $I_x^{r+1}$  be the ideal consisting of all functions in  $F$  whose derivatives of order  $\leq r$  vanish at  $x$ . An element of the quotient algebra  $F/I_x^{r+1}$  is called an  $r$ -jet of a real valued function at  $x$ . (Compare [Ehresmann, 1952].) Construct a locally trivial "bundle of algebras"  $\mathcal{Q}_M^{(r)}$  over  $M$  with typical fiber  $F/I_x^{r+1}$ .

### §3. Constructing New Vector Bundles Out of Old

This section will describe a number of basic constructions involving vector bundles.

(a) **Restricting a bundle to a subset of the base space.** Let  $\xi$  be a vector bundle with projection  $\pi: E \rightarrow B$  and let  $\bar{B}$  be a subset of  $B$ . Setting  $\bar{E} = \pi^{-1}(\bar{B})$ , and letting

$$\bar{\pi}: \bar{E} \rightarrow \bar{B}$$

be the restriction of  $\pi$  to  $\bar{E}$ , one obtains a new vector bundle which will be denoted by  $\xi|_{\bar{B}}$ , and call the *restriction* of  $\xi$  to  $\bar{B}$ . Each fiber  $F_b(\xi|_{\bar{B}})$  is equal to the corresponding fiber  $F_b(\xi)$ , and is to be given the same vector space structure.

As an example if  $M$  is a smooth manifold and  $U$  is an open subset of  $M$ , then the tangent bundle  $\tau_U$  is equal to  $\tau_M|_U$ .

More generally one has the following construction.

(b) **Induced bundles.** Let  $\xi$  be as above and let  $B_1$  be an arbitrary topological space. Given any map  $f: B_1 \rightarrow B$  one can construct the *induced bundle*  $f^*\xi$  over  $B_1$ . The total space  $E_1$  of  $f^*\xi$  is the subset  $E_1 \subset B_1 \times E$  consisting of all pairs  $(b, e)$  with

$$f(b) = \pi(e).$$

The projection map  $\pi_1: E_1 \rightarrow B_1$  is defined by  $\pi_1(b, e) = b$ . Thus one has a commutative diagram

$$\begin{array}{ccc} E_1 & \xrightarrow{\hat{f}} & E \\ \pi_1 \downarrow & & \downarrow \pi \\ B_1 & \xrightarrow{f} & B \end{array}$$

where  $\hat{f}(b, e) = e$ . The vector space structure in  $\pi_1^{-1}(b)$  is defined by

$$t_1(b, e_1) + t_2(b, e_2) = (b, t_1 e_1 + t_2 e_2).$$

Thus  $\hat{f}$  carries each vector space  $F_b(f^*\xi)$  isomorphically onto the vector space  $F_{f(b)}(\xi)$ .

If  $(U, h)$  is a local coordinate system for  $\xi$ , set  $U_1 = f^{-1}(U)$  and define

$$h_1 : U_1 \times \mathbb{R}^n \rightarrow \pi_1^{-1}(U_1)$$

by  $h_1(b, x) = (b, h(f(b), x))$ . Then  $(U_1, h_1)$  is clearly a local coordinate system for  $f^*\xi$ . This proves that  $f^*\xi$  is locally trivial. (If  $\xi$  happens to be trivial, it follows that  $f^*\xi$  is trivial.)

**REMARK.** If  $\xi$  is a smooth vector bundle and  $f$  a smooth map, then it can be shown that  $E_1$  is a smooth submanifold of  $B_1 \times E$ , and hence that  $f^*\xi$  is also a smooth vector bundle.

The above commutative diagram suggests the following concept which a priori, is more general. Let  $\xi$  and  $\eta$  be vector bundles.

**DEFINITION.** A *bundle map* from  $\eta$  to  $\xi$  is a continuous function

$$g : E(\eta) \rightarrow E(\xi)$$

which carries each vector space  $F_b(\eta)$  isomorphically onto one of the vector spaces  $F_{b'}(\xi)$ .

Setting  $\bar{g}(b) = b'$ , it is clear that the resulting function

$$\bar{g} : B(\eta) \rightarrow B(\xi)$$

is continuous.

**LEMMA 3.1.** If  $g : E(\eta) \rightarrow E(\xi)$  is a bundle map, and if  $\bar{g} : B(\eta) \rightarrow B(\xi)$  is the corresponding map of base spaces, then  $\eta$  is isomorphic to the induced bundle  $\bar{g}^*\xi$ .

*Proof.* Define  $h: E(\eta) \rightarrow E(\bar{g}^*\xi)$  by

$$h(e) = (\pi(e), g(e))$$

where  $\pi$  denotes the projection map of  $\eta$ . Since  $h$  is continuous and maps each fiber  $F_b(\eta)$  isomorphically onto the corresponding fiber  $F_b(\bar{g}^*\xi)$ , it follows from Lemma 2.3 that  $h$  is an isomorphism. ■

(c) **Cartesian products.** Given two vector bundles  $\xi_1, \xi_2$  with projection maps  $\pi_i: E_i \rightarrow B_i, i = 1, 2$ , the *Cartesian product*  $\xi_1 \times \xi_2$  is defined to be the bundle with projection map

$$\pi_1 \times \pi_2: E_1 \times E_2 \rightarrow B_1 \times B_2;$$

where each fiber

$$(\pi_1 \times \pi_2)^{-1}(b_1, b_2) = F_{b_1}(\xi_1) \times F_{b_2}(\xi_2)$$

is given the obvious vector space structure. Clearly  $\xi_1 \times \xi_2$  is locally trivial.

As an example, if  $M = M_1 \times M_2$  is a product of smooth manifolds, then the tangent bundle  $\tau_M$  is isomorphic to  $\tau_{M_1} \times \tau_{M_2}$ . (Compare Problem 1-A.)

(d) **Whitney sums.** Next consider two bundles  $\xi_1, \xi_2$  over the same base space  $B$ . Let

$$d: B \rightarrow B \times B$$

denote the diagonal embedding. The bundle  $d^*(\xi_1 \times \xi_2)$  over  $B$  is called the *Whitney sum* of  $\xi_1$  and  $\xi_2$ ; and will be denoted by  $\xi_1 \oplus \xi_2$ . Note that each fiber  $F_b(\xi_1 \oplus \xi_2)$  is canonically isomorphic to the direct sum  $F_b(\xi_1) \oplus F_b(\xi_2)$ .

**DEFINITION.** Consider two vector bundles  $\xi$  and  $\eta$  over the same base space  $B$  with  $E(\xi) \subset E(\eta)$ ; then  $\xi$  is a *sub-bundle* of  $\eta$  (written  $\xi \subset \eta$ ) if each fiber  $F_b(\xi)$  is a sub-vector-space of the corresponding fiber  $F_b(\eta)$ .

LEMMA 3.2. Let  $\xi_1$  and  $\xi_2$  be sub-bundles of  $\eta$  such that each vector space  $F_b(\eta)$  is equal to the direct sum of the subspaces  $F_b(\xi_1)$  and  $F_b(\xi_2)$ . Then  $\eta$  is isomorphic to the Whitney sum  $\xi_1 \oplus \xi_2$ .

*Proof.* Define  $f: E(\xi_1 \oplus \xi_2) \rightarrow E(\eta)$  by  $f(b, e_1, e_2) = e_1 + e_2$ . It follows from Lemma 2.3 that  $f$  is an isomorphism. ■

(e) **Orthogonal complements.** This suggests the following question. Given a sub-bundle  $\xi \subset \eta$  does there exist a complementary sub-bundle so that  $\eta$  splits as a Whitney sum? If  $\eta$  is provided with a Euclidean metric then such a complementary summand can be constructed as follows.\*

Let  $F_b(\xi^\perp)$  denote the subspace of  $F_b(\eta)$  consisting of all vectors  $v$  such that  $v \cdot w = 0$  for all  $w \in F_b(\xi)$ . Let  $E(\xi^\perp) \subset E(\eta)$  denote the union of the  $F_b(\xi^\perp)$ .

THEOREM 3.3.  $E(\xi^\perp)$  is the total space of a sub-bundle  $\xi^\perp \subset \eta$ . Furthermore  $\eta$  is isomorphic to the Whitney sum  $\xi \oplus \xi^\perp$ .

DEFINITION.  $\xi^\perp$  will be called the *orthogonal complement* of  $\xi$  in  $\eta$ .

*Proof.* Clearly each vector space  $F_b(\eta)$  is the direct sum of the subspaces  $F_b(\xi)$  and  $F_b(\xi^\perp)$ . Thus the only problem is to prove that  $\xi^\perp$  satisfies the local triviality condition.

Given any point  $b_0 \in B$ , let  $U$  be a neighborhood of  $b_0$  which is sufficiently small that both  $\xi|U$  and  $\eta|U$  are trivial. Let  $s_1, \dots, s_m$  be normal orthogonal cross-sections of  $\xi|U$  and let  $s'_1, \dots, s'_n$  be normal orthogonal cross-sections of  $\eta|U$ ; where  $m$  and  $n$  are the respective fiber dimensions. (Compare 2.4.) Thus the  $m \times n$  matrix

---

\* If the base space  $B$  is paracompact then  $\eta$  can always be given a Euclidean metric (Problem 2-C); hence a sub-bundle  $\xi \subset \eta$  is always a Whitney summand. If  $B$  is not required to be paracompact, then counterexamples can be given.



$$\left[ s_i(b_0) \cdot s'_j(b_0) \right]$$

has rank  $m$ . Renumbering the  $s'_j$  if necessary, we may assume that the first  $m$  columns are linearly independent.

Let  $V \subset U$  be the open set consisting of all points  $b$  for which the first  $m$  columns of the matrix  $\left[ s_i(b) \cdot s'_j(b) \right]$  are linearly independent. Then the  $n$  cross-sections

$$s_1, s_2, \dots, s_m, s'_{m+1}, \dots, s'_n$$

of  $\eta|U$  are not linearly dependent at any point of  $V$ . (For a linear relation would imply that some non-zero linear combination of  $s_1(b), \dots, s_m(b)$  was also a linear combination of  $s'_{m+1}(b), \dots, s'_n(b)$ , hence orthogonal to  $s'_1(b), \dots, s'_m(b)$ .) Applying the Gram-Schmidt process to this sequence of cross-sections, we obtain normal orthogonal cross-sections  $s_1, \dots, s_m, s_{m+1}, \dots, s_n$  of  $\eta|V$ .

Now a local coordinate system

$$h: V \times \mathbb{R}^{n-m} \rightarrow E(\xi^\perp)$$

for  $\xi^\perp$  is given by the formula

$$h(b, x) = x_1 s_{m+1}(b) + \dots + x_{n-m} s_n(b).$$

The identity

$$h^{-1}(e) = (\pi e, (e \cdot s_{m+1}(\pi e), \dots, e \cdot s_n(\pi e)))$$

shows that  $h$  is a homeomorphism, and completes the proof of Theorem 3.3. ■

As an example, suppose that  $M \subset N \subset \mathbb{R}^A$  are smooth manifolds, and suppose that  $N$  is provided with a Riemannian metric. Then the tangent bundle  $\tau_M$  is a sub-bundle of the restriction  $\tau_N|M$ . In this case the orthogonal complement  $\tau_M^\perp \subset \tau_N|M$  is called the *normal bundle*  $\nu$  of  $M$  in  $N$ . Thus we have:

COROLLARY 3.4. For any smooth submanifold  $M$  of a smooth Riemannian manifold  $N$  the normal bundle  $\nu$  is defined, and

$$\tau_M \oplus \nu \cong \tau_N|_M .$$

More generally a smooth map  $f: M \rightarrow N$  between smooth manifolds is called an *immersion* if the Jacobian

$$Df_x: DM_x \rightarrow DN_{f(x)}$$

maps the tangent space  $DM_x$  injectively (i.e., with kernel zero) for each  $x \in M$ . [It follows from the implicit function theorem that an immersion is locally an embedding of  $M$  in  $N$ , but in the large there may be self-intersections. A typical immersion of the circle in the plane is illustrated in Figure 4.]

Suppose that  $N$  is a Riemannian manifold. Then for each  $x \in M$ , the tangent space  $DN_{f(x)}$  splits as the direct sum of the image  $Df_x(DM_x)$  and its orthogonal complement. Correspondingly the induced bundle  $f^*\tau_N$  over  $M$  splits as the Whitney sum of a sub-bundle isomorphic to  $\tau_M$  and a complementary sub-bundle  $\nu_f$ . Thus:

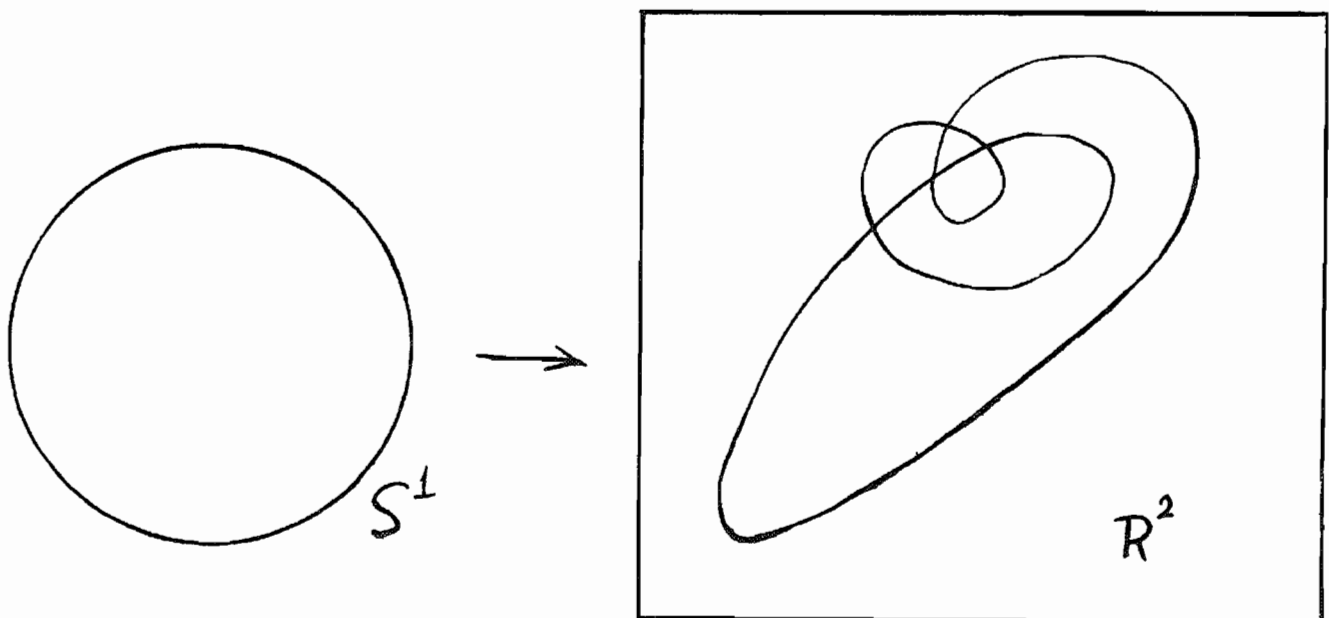

Figure 4.

COROLLARY 3.5. For any immersion  $f: M \rightarrow N$ , with  $N$  Riemannian, there is a Whitney sum decomposition

$$f^*\tau_N \cong \tau_M \oplus \nu_f.$$

This bundle  $\nu_f$  will be called the *normal bundle* of the immersion  $f$ .

(f) Continuous functors of vector spaces and vector bundles. The direct sum operation is perhaps the most important method for building new vector spaces out of old, but many other such constructions play an important role in differential geometry. For example, to any pair  $V, W$  of real vector spaces one can assign:

- 1) the vector space  $\text{Hom}(V, W)$  of linear transformations from  $V$  to  $W$ ;
- 2) the tensor product\*  $V \otimes W$ ;
- 3) the vector space of all symmetric bilinear transformations from  $V \times V$  to  $W$ ; and so on.

To a single vector space  $V$  one can assign:

- 4) the dual vector space  $\text{Hom}(V, \mathbb{R})$ ;
- 5) the  $k$ -th exterior power\*  $\Lambda^k V$ ;
- 6) the vector space of all 4-linear transformations  $K: V \times V \times V \times V \rightarrow \mathbb{R}$  satisfying the symmetry relations:

$$K(v_1, v_2, v_3, v_4) = K(v_3, v_4, v_1, v_2) = -K(v_1, v_2, v_4, v_3)$$

and

$$K(v_1, v_2, v_3, v_4) + K(v_1, v_4, v_2, v_3) + K(v_1, v_3, v_4, v_2) = 0.$$

(This last example would be rather far-fetched, were it not important in the theory of Riemannian curvature.)

These examples suggest that we consider a general functor of several vector space variables.

---

\* See for example [Lang, pp. 408, 424].

Let  $\mathcal{O}$  denote the category consisting of all finite dimensional real vector spaces and all isomorphisms between such vector spaces. By a (covariant)\* *functor*  $T: \mathcal{O} \times \mathcal{O} \rightarrow \mathcal{O}$  is meant an operation which assigns

1) to each pair  $V, W \in \mathcal{O}$  of vector spaces a vector space  $T(V, W) \in \mathcal{O}$ ; and

2) to each pair  $f: V \rightarrow V', g: W \rightarrow W'$  of isomorphisms an isomorphism

$$T(f, g) : T(V, W) \rightarrow T(V', W') ;$$

so that

3)  $T(\text{identity}_V, \text{identity}_W) = \text{identity}_{T(V, W)}$  and

4)  $T(f_1 \circ f_2, g_1 \circ g_2) = T(f_1, g_1) \circ T(f_2, g_2)$ .

Such a functor will be called *continuous* if  $T(f, g)$  depends continuously on  $f$  and  $g$ . This makes sense, since the set of all isomorphisms from one finite dimensional vector space to another has a natural topology.

The concept of a continuous functor  $T: \mathcal{O} \times \dots \times \mathcal{O} \rightarrow \mathcal{O}$  in  $k$  variables is defined similarly. Note that examples 1, 2, 3 above are continuous functors of two variables, and that examples 4, 5, 6 are continuous functors of one variable.

Let  $T: \mathcal{O} \times \dots \times \mathcal{O} \rightarrow \mathcal{O}$  be such a continuous functor of  $k$  variables, and let  $\xi_1, \dots, \xi_k$  be vector bundles over a common base space  $B$ . Then a new vector bundle over  $B$  is constructed as follows. For each  $b \in B$  let

$$F_b = T(F_b(\xi_1), \dots, F_b(\xi_k)) .$$

Let  $E$  denote the disjoint union of the vector spaces  $F_b$  and define  $\pi: E \rightarrow B$  by  $\pi(F_b) = b$ .

**THEOREM 3.6.** *There exists a canonical topology for  $E$  so that  $E$  is the total space of a vector bundle with projection  $\pi$  and with fibers  $F_b$ .*

\*

The distinction between covariant and contravariant functors is not important here, since we are working only with isomorphisms.

DEFINITION. This bundle will be denoted by  $T(\xi_1, \dots, \xi_k)$ .

For example starting with the tensor product functor, this construction defines the *tensor product*  $\xi \otimes \eta$  of two vector bundles. Starting with the direct sum functor one obtains the Whitney sum  $\xi \oplus \eta$  of two bundles. Starting with the duality functor

$$V \mapsto \text{Hom}(V, \mathbb{R})$$

one obtains the functor

$$\xi \mapsto \text{Hom}(\xi, \varepsilon^1)$$

which assigns to each vector bundle its *dual vector bundle*.

The proof of 3.6 will be indicated only briefly. Let  $(U, h_1), \dots, (U, h_k)$  be local coordinate systems for  $\xi_1, \dots, \xi_k$  respectively, all using the same open set  $U$ . For each  $b \in U$  define

$$h_{ib} : \mathbb{R}^{n_i} \rightarrow F_b(\xi_i)$$

by  $h_{ib}(x) = h_i(b, x)$ . Then the isomorphism

$$T(h_{1b}, \dots, h_{kb}) : T(\mathbb{R}^{n_1}, \dots, \mathbb{R}^{n_k}) \rightarrow F_b$$

is defined. The correspondence

$$(b, x) \mapsto T(h_{1b}, \dots, h_{kb})(x)$$

defines a one-to-one function

$$h : U \times T(\mathbb{R}^{n_1}, \dots, \mathbb{R}^{n_k}) \rightarrow \pi^{-1}(U).$$

ASSERTION. There is a unique topology on  $E$  so that each such  $h$  is a homeomorphism, and so that each  $\pi^{-1}(U)$  is an open subset of  $E$ .

*Proof.* The uniqueness is clear. To prove existence, it is only necessary to observe that if two such "coordinate systems"  $(U, h)$  and  $(U', h')$  overlap, then the transformation

$$(U \cap U') \times T(\mathbb{R}^{n_1}, \dots, \mathbb{R}^{n_k}) \xrightarrow{h^{-1} \circ h'} (U \cap U') \times T(\mathbb{R}^{n_1}, \dots, \mathbb{R}^{n_k})$$

is continuous. This follows from the continuity of  $T$ .

It is now clear that  $\pi: E \rightarrow B$  is continuous, and that the resulting vector bundle  $T(\xi_1, \dots, \xi_k)$  satisfies the local triviality condition. ■

**REMARK 1.** This construction can be translated into Steenrod's terminology as follows. Let  $GL_n = GL_n(\mathbb{R})$  denote the group of automorphisms of the vector space  $\mathbb{R}^n$ . Then  $T$  determines a continuous homomorphism from the product group  $GL_{n_1} \times \dots \times GL_{n_k}$  to the group  $GL'$  of automorphisms of the vector space  $T(\mathbb{R}^{n_1}, \dots, \mathbb{R}^{n_k})$ . Hence given bundles  $\xi_1, \dots, \xi_k$  over  $B$  with structural groups  $GL_{n_1}, \dots, GL_{n_k}$  respectively, there corresponds a bundle  $T(\xi_1, \dots, \xi_k)$  with structural group  $GL'$  and with fiber  $T(\mathbb{R}^{n_1}, \dots, \mathbb{R}^{n_k})$ . For further discussion, see [Hirzebruch, 1966, §3.6].

**REMARK 2.** Given bundles  $\xi_1, \dots, \xi_k$  over distinct base spaces, a similar construction gives rise to a vector bundle  $\hat{T}(\xi_1, \dots, \xi_k)$  over  $B(\xi_1) \times \dots \times B(\xi_k)$ , with typical fiber  $T(F_{b_1}(\xi_1), \dots, F_{b_k}(\xi_k))$ . This yields a functor  $\hat{T}$  from the category of vector bundles and bundle maps into itself. As an example, starting from the direct sum functor  $\oplus$  on the category  $\mathcal{O}$  one obtains the Cartesian product functor

$$\xi, \eta \mapsto \xi \hat{\otimes} \eta = \xi \times \eta$$

for vector bundles.

**REMARK 3.** If  $\xi_1, \dots, \xi_k$  are smooth vector bundles, then  $T(\xi_1, \dots, \xi_k)$  can also be given the structure of a smooth vector bundle. The proof is similar to that of 3.6. It is necessary to make use of the fact that the isomorphism  $T(f_1, \dots, f_k)$  is a smooth function of the isomorphisms  $f_1, \dots, f_k$ . This follows from [Chevalley, p. 128].

As an illustration, let  $f: M \rightarrow N$  be a smooth map. Then  $\text{Hom}(\tau_M, f^*\tau_N)$  is a smooth vector bundle over  $M$ . Note that  $Df$  gives rise to a smooth cross-section of this vector bundle.

As a second illustration, if  $M \subset N$  with normal bundle  $\nu$ , where  $N$  is a smooth Riemannian manifold, then the "second fundamental form" can be defined as a smooth symmetric cross-section of the bundle  $\text{Hom}(\tau_M \otimes \tau_M, \nu)$ . (Compare [Bishop and Crittenden], as well as Problem 5-B.)

Here are six problems for the reader.

*Problem 3-A.* A smooth map  $f : M \rightarrow N$  between smooth manifolds is called a *submersion* if each Jacobian

$$Df_x : DM_x \rightarrow DN_{f(x)}$$

is surjective (i.e., is onto). Construct a vector bundle  $\kappa_f$  built up out of the kernels of the  $Df_x$ . If  $M$  is Riemannian, show that

$$\tau_M \cong \kappa_f \oplus f^*\tau_N.$$

*Problem 3-B.* Given vector bundles  $\xi \subset \eta$  define the *quotient bundle*  $\eta/\xi$  and prove that it is locally trivial. If  $\eta$  has a Euclidean metric, show that

$$\xi^\perp \cong \eta/\xi.$$

*Problem 3-C.* More generally let  $\xi, \eta$  be arbitrary vector bundles over  $B$  and let  $f$  be a cross-section of the bundle  $\text{Hom}(\xi, \eta)$ . If the rank of the linear function

$$f(b) : F_b(\xi) \rightarrow F_b(\eta)$$

is locally constant as a function of  $b$ , define the kernel  $\kappa_f \subset \xi$  and the cokernel  $\nu_f$ , and prove that they are locally trivial.

*Problem 3-D.* If a vector bundle  $\xi$  possesses a Euclidean metric, show that  $\xi$  is isomorphic to its dual bundle  $\text{Hom}(\xi, \varepsilon^1)$ .

*Problem 3-E.* Show that the set of isomorphism classes of 1-dimensional vector bundles over  $B$  forms an abelian group with respect

to the tensor product operation. Show that a given  $\mathbb{R}^1$ -bundle  $\xi$  possesses a Euclidean metric if and only if  $\xi$  represents an element of order  $\leq 2$  in this group.

*Problem 3-F.* (Compare [Swan].) Let  $B$  be a Tychonoff space\* and let  $R(B)$  denote the ring of continuous real valued functions on  $B$ . For any vector bundle  $\xi$  over  $B$  let  $S(\xi)$  denote the  $R(B)$ -module consisting of all cross-sections of  $\xi$ .

a) Show that  $S(\xi \oplus \eta) \cong S(\xi) \oplus S(\eta)$ . Show that  $\xi$  is trivial if and only if  $S(\xi)$  is free.

b) If  $\xi \oplus \eta$  is trivial, show that  $S(\xi)$  is a finitely generated projective module.\*\* Conversely if  $Q$  is a finitely generated projective module over  $R(B)$ , show that  $Q \cong S(\xi)$  for some  $\xi$ .

c) Show that  $\xi \cong \eta$  if and only if  $S(\xi) \cong S(\eta)$ .

---

\* A topological space is *Tychonoff* if it is Hausdorff, and if for every point  $x$  and disjoint closed subset  $A$  there exists a continuous real valued function separating  $x$  from  $A$ . Compare [Kelley].

\*\* A module is *projective* if it is a direct summand of a free module. See for example [Mac Lane and Birkhoff, p. 368].



#### §4. Stiefel-Whitney Classes

This section will begin the study of characteristic classes by introducing four axioms which characterize the Stiefel-Whitney cohomology classes of a vector bundle. The existence and uniqueness of cohomology classes satisfying these axioms will only be established in later sections.

The expression  $H^i(B; G)$  denotes the  $i$ -th singular cohomology group of  $B$  with coefficients in  $G$ . For an outline of basic definitions and theorems concerning singular cohomology theory, the reader is referred to Appendix A. In this section the coefficient group will always be  $\mathbb{Z}/2$ , the group of integers modulo 2.

**AXIOM 1.** To each vector bundle  $\xi$  there corresponds a sequence of cohomology classes

$$w_i(\xi) \in H^i(B(\xi); \mathbb{Z}/2), \quad i = 0, 1, 2, \dots,$$

called the *Stiefel-Whitney classes* of  $\xi$ . The class  $w_0(\xi)$  is equal to the unit element

$$1 \in H^0(B(\xi); \mathbb{Z}/2),$$

and  $w_i(\xi)$  equals zero for  $i$  greater than  $n$  if  $\xi$  is an  $n$ -plane bundle.

**AXIOM 2. NATURALITY.** If  $f: B(\xi) \rightarrow B(\eta)$  is covered by a bundle map from  $\xi$  to  $\eta$ , then

$$w_i(\xi) = f^*w_i(\eta).$$

**AXIOM 3. THE WHITNEY PRODUCT THEOREM.** If  $\xi$  and  $\eta$  are vector bundles over the same base space, then

$$w_k(\xi \oplus \eta) = \sum_{i=0}^k w_i(\xi) \cup w_{k-i}(\eta).$$

For example  $w_1(\xi \oplus \eta) = w_1(\xi) + w_1(\eta)$ ,

$$w_2(\xi \oplus \eta) = w_2(\xi) + w_1(\xi)w_1(\eta) + w_2(\eta), \text{ etc.}$$

(We will omit the symbol  $\cup$  for cup product whenever it seems convenient.)

AXIOM 4. For the line bundle  $\gamma_1^1$  over the circle  $P^1$ , the Stiefel-Whitney class  $w_1(\gamma_1^1)$  is non-zero.

REMARKS. Characteristic *homology* classes for the tangent bundle of a smooth manifold were defined by [Stiefel] in 1935. In the same year [Whitney] defined the classes  $w_i$  for any sphere bundle over a simplicial complex. (A "sphere bundle" is the object obtained from a Euclidean vector bundle by considering only vectors of unit length in the total space.) The Whitney product theorem is due to [Whitney, 1940, 1941] and [Wu, 1948]. This axiomatic definition of Stiefel-Whitney classes was suggested by [Hirzebruch, 1966, p. 58], where an analogous definition of Chern classes is given.

It is not at all obvious that classes  $w_i(\xi)$  satisfying the four axioms can be defined. Nevertheless this will be assumed for the rest of §4. A number of applications of this assumption will be given.

### Consequences of the Four Axioms

As immediate consequences of Axiom 2 one has the following.

PROPOSITION 1. If  $\xi$  is isomorphic to  $\eta$  then  $w_i(\xi) = w_i(\eta)$ .

PROPOSITION 2. If  $\varepsilon$  is a trivial vector bundle then  $w_i(\varepsilon) = 0$  for  $i > 0$ .

For if  $\varepsilon$  is trivial then there exists a bundle map from  $\varepsilon$  to a vector bundle over a point.

Combining this information with the Whitney product theorem, one obtains:

PROPOSITION 3. If  $\varepsilon$  is trivial, then  $w_1(\varepsilon \oplus \eta) = w_1(\eta)$ .

PROPOSITION 4. If  $\xi$  is an  $\mathbb{R}^n$ -bundle with a Euclidean metric which possesses a nowhere zero cross-section, then  $w_n(\xi) = 0$ . If  $\xi$  possesses  $k$  cross-sections which are nowhere linearly dependent, then

$$w_{n-k+1}(\xi) = w_{n-k+2}(\xi) = \dots = w_n(\xi) = 0.$$

For it follows from Theorem 3.3 that  $\xi$  splits as a Whitney sum  $\varepsilon \oplus \varepsilon^\perp$  where  $\varepsilon$  is trivial and  $\varepsilon^\perp$  has dimension  $n-k$ .

A particularly interesting case of the Whitney product theorem occurs when the Whitney sum  $\xi \oplus \eta$  is trivial. Then the relations

$$w_1(\xi) + w_1(\eta) = 0$$

$$w_2(\xi) + w_1(\xi)w_1(\eta) + w_2(\eta) = 0$$

$$w_3(\xi) + w_2(\xi)w_1(\eta) + w_1(\xi)w_2(\eta) + w_3(\eta) = 0, \text{ etc.,}$$

can be solved inductively, so that  $w_i(\eta)$  is expressed as a polynomial in the Stiefel-Whitney classes of  $\xi$ . It is convenient to introduce the following formalism.

DEFINITION.  $H^\Pi(B; \mathbb{Z}/2)$  will denote the ring consisting of all formal infinite series

$$a = a_0 + a_1 + a_2 + \dots$$

with  $a_i \in H^i(B; \mathbb{Z}/2)$ . The product operation in this ring is to be given by the formula  $(a_0 + a_1 + a_2 + \dots)(b_0 + b_1 + b_2 + \dots) = (a_0 b_0) + (a_1 b_0 + a_0 b_1) + (a_2 b_0 + a_1 b_1 + a_0 b_2) + \dots$ . This product is commutative (since we are working modulo 2) and associative. Additively,  $H^\Pi(B; \mathbb{Z}/2)$  is to be simply the Cartesian product of the groups  $H^i(B; \mathbb{Z}/2)$ .

The total Stiefel-Whitney class of an  $n$ -plane bundle  $\xi$  over  $B$  is defined to be the element

$$w(\xi) = 1 + w_1(\xi) + w_2(\xi) + \dots + w_n(\xi) + 0 + \dots$$

of this ring. Note that the Whitney product theorem can now be expressed by the simple formula

$$w(\xi \oplus \eta) = w(\xi) w(\eta) .$$

LEMMA 4.1. *The collection of all infinite series*

$$w = 1 + w_1 + w_2 + \dots \quad \in H^{\Pi}(B; \mathbb{Z}/2)$$

*with leading term 1 forms a commutative group under multiplication.*

(This is precisely the group of units of the ring  $H^{\Pi}(B; \mathbb{Z}/2)$ .)

*Proof.* The inverse

$$\bar{w} = 1 + \bar{w}_1 + \bar{w}_2 + \bar{w}_3 + \dots$$

of a given element  $w$  can be constructed inductively by the algorithm

$$\bar{w}_n = w_1 \bar{w}_{n-1} + w_2 \bar{w}_{n-2} + \dots + w_{n-1} \bar{w}_1 + w_n .$$

Thus one obtains:

$$\bar{w}_1 = w_1$$

$$\bar{w}_2 = w_1^2 + w_2$$

$$\bar{w}_3 = w_1^3 + w_3$$

$$\bar{w}_4 = w_1^4 + w_1^2 w_2 + w_2^2 + w_4 ,$$

and so on. This completes the proof. ■

Alternatively  $\bar{w}$  can be computed by the power series expansion:

$$\begin{aligned} \bar{w} &= [1 + (w_1 + w_2 + w_3 + \dots)]^{-1} \\ &= 1 - (w_1 + w_2 + w_3 + \dots) + (w_1 + w_2 + \dots)^2 - (w_1 + w_2 + \dots)^3 + \dots \\ &= 1 - w_1 + (w_1^2 - w_2) + (-w_1^3 + 2w_1 w_2 - w_3) + \dots \end{aligned}$$

(where the signs are of course irrelevant). This leads to the precise expression  $(i_1 + \dots + i_k)! / i_1! \dots i_k!$  for the coefficient of  $w_1^{i_1} w_2^{i_2} \dots w_k^{i_k}$  in  $\bar{w}$ .

Now consider two vector bundles  $\xi$  and  $\eta$  over the same base space. It follows from 4.1 that the equation

$$w(\xi \oplus \eta) = w(\xi) w(\eta)$$

can be uniquely solved as

$$w(\eta) = \bar{w}(\xi) w(\xi \oplus \eta).$$

In particular, if  $\xi \oplus \eta$  is trivial, then

$$w(\eta) = \bar{w}(\xi).$$

One important special case is the following.

**LEMMA 4.2** Whitney duality theorem. *If  $\tau_M$  is the tangent bundle of a manifold in Euclidean space and  $\nu$  is the normal bundle then*

$$w_i(\nu) = \bar{w}_i(\tau_M).$$

Now let us compute the Stiefel-Whitney classes in some special cases. It will frequently be convenient to use the abbreviation  $w(M)$  for the total Stiefel-Whitney class of a tangent bundle  $\tau_M$ .

*Example 1.* For the tangent bundle  $\tau$  of the unit sphere  $S^n$ , the class  $w(\tau) = w(S^n)$  is equal to 1. In other words,  $\tau$  cannot be distinguished from the trivial bundle over  $S^n$  by means of Stiefel-Whitney classes.

*Proof.* For the standard imbedding  $S^n \subset \mathbb{R}^{n+1}$ , the normal bundle  $\nu$  is trivial. Since  $w(\tau)w(\nu) = 1$  and  $w(\nu) = 1$  it follows that  $w(\tau) = 1$ .

*Alternative proof* (without using the Whitney product theorem). The canonical map

$$f: S^n \rightarrow P^n$$

to projective space is locally a diffeomorphism. Hence the induced map

$$Df: DS^n \rightarrow DP^n$$

of tangent bundles is a bundle map. Applying Axiom 2, one obtains the identity

$$f^* w_n(P^n) = w_n(S^n);$$

where the homomorphism

$$f^*: H^n(P^n; \mathbb{Z}/2) \rightarrow H^n(S^n; \mathbb{Z}/2)$$

is well known to be zero. (Compare the remark below.) Therefore  $w_n(S^n) = 0$ , which completes the alternative proof. ■

The rest of §4 will be concerned with bundles over the projective space  $P^n$ . It is first necessary to describe the mod 2 cohomology of  $P^n$ .

**LEMMA 4.3.** *The group  $H^i(P^n; \mathbb{Z}/2)$  is cyclic of order 2 for  $0 \leq i \leq n$  and is zero for higher values of  $i$ . Furthermore, if  $a$  denotes the non-zero element of  $H^1(P^n; \mathbb{Z}/2)$  then each  $H^i(P^n; \mathbb{Z}/2)$  is generated by the  $i$ -fold cup product  $a^i$ .*

Thus  $H^*(P^n; \mathbb{Z}/2)$  can be described as the algebra with unit over  $\mathbb{Z}/2$  having one generator  $a$  and one relation  $a^{n+1} = 0$ .

For a proof the reader may refer to [Hilton and Wylie, §4.3.3] or [Spanier, p. 264]. See Problems 11-A and 12-C. (Compare 14.4.)

**REMARK.** This lemma can be used to compute the homomorphism

$$f^*: H^n(P^n; \mathbb{Z}/2) \rightarrow H^n(S^n; \mathbb{Z}/2)$$

providing that  $n > 1$ . In fact

$$f^*(a^n) = (f^*a)^n$$

is zero since  $f^*a \in H^1(S^n; \mathbb{Z}/2) = 0$ .

*Example 2.* The total Stiefel-Whitney class of the canonical line bundle  $\gamma_n^1$  over  $P^n$  is given by

$$w(\gamma_n^1) = 1 + a .$$

*Proof.* The standard inclusion  $j: P^1 \rightarrow P^n$  is clearly covered by a bundle map from  $\gamma_1^1$  to  $\gamma_n^1$ . Therefore

$$j^* w_1(\gamma_n^1) = w_1(\gamma_1^1) \neq 0 .$$

This shows that  $w_1(\gamma_n^1)$  cannot be zero, hence must be equal to  $a$ . Since the remaining Stiefel-Whitney classes of  $\gamma_n^1$  are determined by Axiom 1, this completes the proof. ■

*Example 3.* By its definition, the line bundle  $\gamma_n^1$  over  $P^n$  is contained as a sub-bundle in the trivial bundle  $\varepsilon^{n+1}$ . Let  $\gamma^\perp$  denote the orthogonal complement of  $\gamma_n^1$  in  $\varepsilon^{n+1}$ . (Thus the total space  $E(\gamma^\perp)$  consists of all pairs

$$(\{\pm x\}, v) \in P^n \times R^{n+1}$$

with  $v$  perpendicular to  $x$ .) Then

$$w(\gamma^\perp) = 1 + a + a^2 + \dots + a^n .$$

*Proof.* Since  $\gamma_n^1 \oplus \gamma^\perp$  is trivial we have

$$w(\gamma^\perp) = \bar{w}(\gamma_n^1) = (1+a)^{-1} = 1 + a + a^2 + \dots + a^n . \blacksquare$$

This example shows that all of the  $n$  Stiefel-Whitney classes of an  $R^n$ -bundle may be non-zero.

*Example 4.* Let  $\tau$  be the tangent bundle of the projective space  $P^n$ .

LEMMA 4.4. *The tangent bundle  $\tau$  of  $P^n$  is isomorphic to  $\text{Hom}(\gamma_n^1, \gamma^\perp)$ .*

*Proof.* Let  $L$  be a line through the origin in  $\mathbb{R}^{n+1}$ , intersecting  $S^n$  in the points  $\pm x$ , and let  $L^\perp \subset \mathbb{R}^{n+1}$  be the complementary  $n$ -plane. Let  $f: S^n \rightarrow P^n$  denote the canonical map,  $f(x) = \{\pm x\}$ . Note that the two tangent vectors  $(x, v)$  and  $(-x, -v)$  in  $DS^n$  both have the same image under the map

$$Df: DS^n \rightarrow DP^n$$

which is induced by  $f$ . (Compare Figure 5.) Thus the tangent manifold  $DP^n$  can be identified with the set of all pairs  $\{(x, v), (-x, -v)\}$  satisfying

$$x \cdot x = 1, \quad x \cdot v = 0.$$

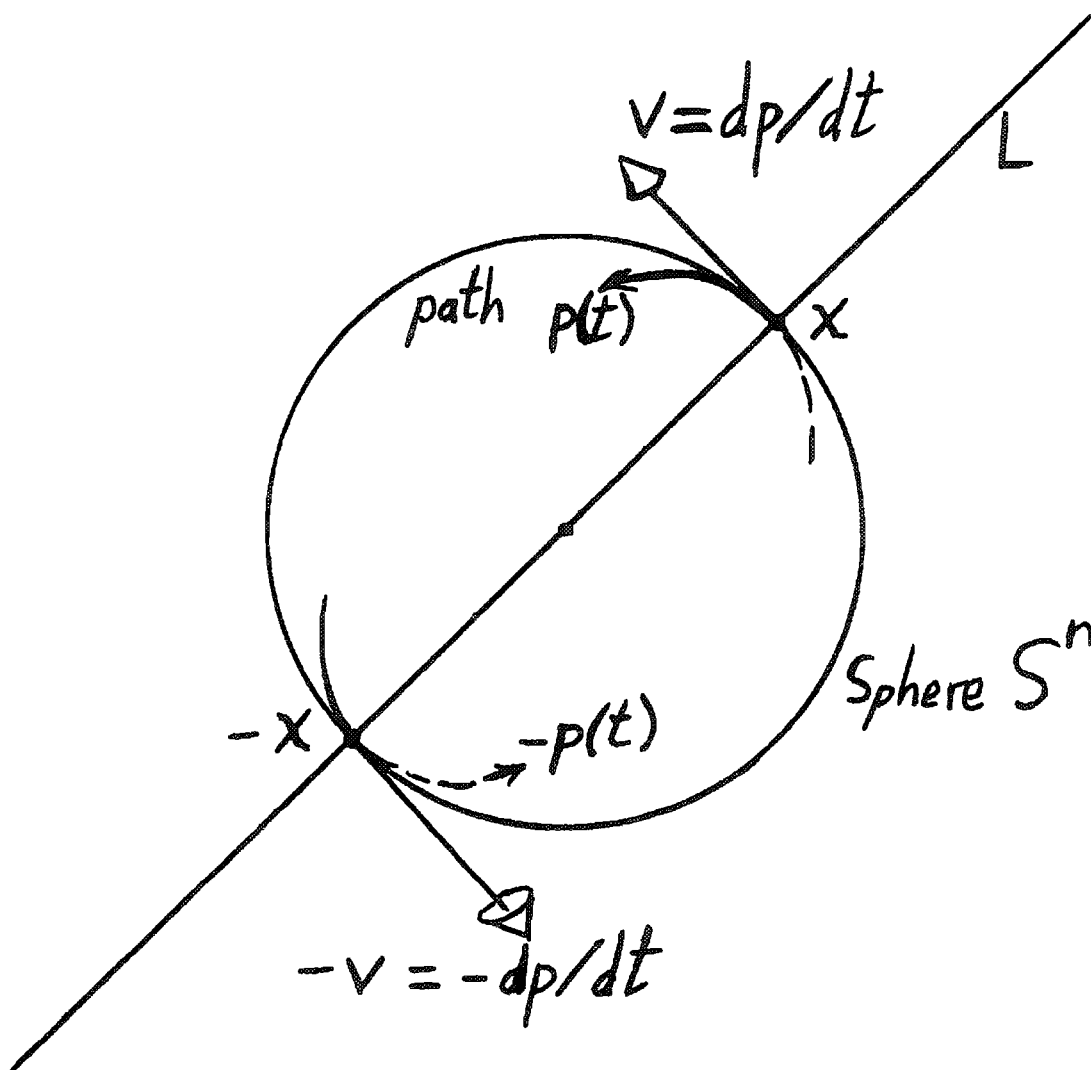

Figure 5.



But each such pair determines, and is determined by, a linear mapping

$$\ell: L \rightarrow L^\perp,$$

where

$$\ell(x) = v.$$

Thus the tangent space of  $P^n$  at  $\{\pm x\}$  is canonically isomorphic to the vector space  $\text{Hom}(L, L^\perp)$ . It follows that the tangent vector bundle  $\tau$  is canonically isomorphic to the bundle  $\text{Hom}(\gamma_n^1, \gamma_n^\perp)$ . This completes the proof of 4.4. ■

We cannot compute  $w(P^n)$  directly from this lemma since we do not yet have any procedure for relating the Stiefel-Whitney classes of  $\text{Hom}(\gamma_n^1, \gamma_n^\perp)$  to those of  $\gamma_n^1$  and  $\gamma_n^\perp$ . However the computation can be carried through as follows. Let  $\varepsilon^1$  be a trivial line bundle over  $P^n$ .

**THEOREM 4.5.** *The Whitney sum  $\tau \oplus \varepsilon^1$  is isomorphic to the  $(n+1)$ -fold Whitney sum  $\gamma_n^1 \oplus \gamma_n^1 \oplus \dots \oplus \gamma_n^1$ . Hence the total Stiefel-Whitney class of  $P^n$  is given by*

$$w(P^n) = (1+a)^{n+1} = 1 + \binom{n+1}{1}a + \binom{n+1}{2}a^2 + \dots + \binom{n+1}{n}a^n.$$

*Proof.* The bundle  $\text{Hom}(\gamma_n^1, \gamma_n^\perp)$  is trivial since it is a line bundle with a canonical nowhere zero cross-section. Therefore

$$\tau \oplus \varepsilon^1 \cong \text{Hom}(\gamma_n^1, \gamma_n^\perp) \oplus \text{Hom}(\gamma_n^1, \gamma_n^\perp).$$

This is clearly isomorphic to

$$\text{Hom}(\gamma_n^1, \gamma_n^\perp \oplus \gamma_n^1) \cong \text{Hom}(\gamma_n^1, \varepsilon^{n+1}),$$

and therefore is isomorphic to the  $(n+1)$ -fold sum

$$\text{Hom}(\gamma_n^1, \varepsilon^1 \oplus \dots \oplus \varepsilon^1) \cong \text{Hom}(\gamma_n^1, \varepsilon^1) \oplus \dots \oplus \text{Hom}(\gamma_n^1, \varepsilon^1).$$

But the bundle  $\text{Hom}(\gamma_n^1, \varepsilon^1)$  is isomorphic to  $\gamma_n^1$ , since  $\gamma_n^1$  has a Euclidean metric. (Compare Problem 3-D.) This proves that

$$\tau \oplus \varepsilon^1 \cong \gamma_n^1 \oplus \dots \oplus \gamma_n^1 .$$

Now the Whitney product theorem implies that  $w(\tau) = w(\tau \oplus \varepsilon^1)$  is equal to

$$w(\gamma_n^1) \dots w(\gamma_n^1) = (1+a)^{n+1} .$$

Expanding by the binomial theorem, this completes the proof of 4.5. ■

Here is a table of the binomial coefficients  $\binom{n+1}{i}$  modulo 2, for  $n \leq 14$ .

					1										
					1	1									
P <sup>1</sup> :				1	0	1									
P <sup>2</sup> :			1	1	1	1									
P <sup>3</sup> :			1	0	0	0	1								
P <sup>4</sup> :			1	1	0	0	1	1							
P <sup>5</sup> :			1	0	1	0	1	0	1						
P <sup>6</sup> :			1	1	1	1	1	1	1	1					
P <sup>7</sup> :			1	0	0	0	0	0	0	0	1				
P <sup>8</sup> :			1	1	0	0	0	0	0	0	1	1			
P <sup>9</sup> :			1	0	1	0	0	0	0	1	0	1			
P <sup>10</sup> :			1	1	1	1	0	0	0	1	1	1	1		
P <sup>11</sup> :			1	0	0	0	1	0	0	1	0	0	0	1	
P <sup>12</sup> :			1	1	0	0	1	1	0	0	1	1	0	0	1
P <sup>13</sup> :			1	0	1	0	1	0	1	0	1	0	1	0	1
P <sup>14</sup> :	1	1	1	1	1	1	1	1	1	1	1	1	1	1	1

The right hand edge of this triangle can be ignored for our purposes since  $H^{n+1}(\mathbb{P}^n; \mathbb{Z}/2) = 0$ . As examples one has:

$$w(P^2) = 1 + a + a^2$$

$$w(P^3) = 1$$

and

$$w(P^4) = 1 + a + a^4 .$$

**COROLLARY 4.6** (Stiefel). *The class  $w(P^n)$  is equal to 1 if and only if  $n + 1$  is a power of 2. Thus the only projective spaces which can be parallelizable are  $P^1, P^3, P^7, P^{15}, \dots$ .*

(We will see in a moment that  $P^1, P^3,$  and  $P^7$  actually are parallelizable. On the other hand it is known that the higher projective spaces  $P^{15}, P^{31}, \dots$  are not parallelizable. See [Bott-Milnor], [Kervaire, 1958], [Adams, 1960].)

*Proof.* The identity  $(a + b)^2 \equiv a^2 + b^2$  modulo 2 implies that

$$(1 + a)^{2^r} = 1 + a^{2^r} .$$

Therefore if  $n + 1 = 2^r$  then

$$w(P^n) = (1 + a)^{n+1} = 1 + a^{n+1} = 1 .$$

Conversely if  $n + 1 = 2^r m$  with  $m$  odd,  $m > 1$ , then

$$\begin{aligned} w(P^n) &= (1 + a)^{n+1} = (1 + a^{2^r})^m \\ &= 1 + m a^{2^r} + \frac{m(m-1)}{2} a^{2 \cdot 2^r} + \dots \neq 1 , \end{aligned}$$

since  $2^r < n + 1$ . This completes the proof. ■

### Division algebras

Closely related is the question of the existence of real division algebras.

**THEOREM 4.7 (Stiefel).** *Suppose that there exists a bilinear product operation\**

$$p: \mathbb{R}^n \times \mathbb{R}^n \rightarrow \mathbb{R}^n$$

*without zero divisors. Then the projective space  $P^{n-1}$  is parallelizable, hence  $n$  must be a power of 2.*

In fact such division algebras are known to exist for  $n = 1, 2, 4, 8$ : namely the real numbers, the complex numbers, the quaternions, and the Cayley numbers. It follows that the projective spaces  $P^1$ ,  $P^3$  and  $P^7$  are parallelizable. That no such division algebra exists for  $n > 8$  follows from the references cited above on parallelizability.

*Proof of 4.7.* Let  $b_1, \dots, b_n$  be the standard basis for the vector space  $\mathbb{R}^n$ . Note that the correspondence

$$y \mapsto p(y, b_1)$$

defines an isomorphism of  $\mathbb{R}^n$  onto itself. Hence the formula

$$v_i(p(y, b_1)) = p(y, b_i)$$

defines a linear transformation

$$v_i: \mathbb{R}^n \rightarrow \mathbb{R}^n.$$

Note that  $v_1(x), \dots, v_n(x)$  are linearly independent for  $x \neq 0$ , and that  $v_1(x) = x$ .

The functions  $v_2, \dots, v_n$  give rise to  $n - 1$  linearly independent cross-sections of the vector bundle

$$\tau_{P^{n-1}} \cong \text{Hom}(\gamma_{n-1}^1, \gamma^{\perp}).$$

In fact for each line  $L$  through the origin, a linear transformation

---

\* This product operation is not required to be associative, or to have an identity element.

$$\bar{v}_i : L \rightarrow L^\perp$$

is defined as follows. For  $x \in L$ , let  $\bar{v}_i(x)$  denote the image of  $v_i(x)$  under the orthogonal projection

$$R^n \rightarrow L^\perp.$$

Clearly  $\bar{v}_1 = 0$ , but  $\bar{v}_2, \dots, \bar{v}_n$  are everywhere linearly independent. Thus the tangent bundle  $\tau_{P^{n-1}}$  is a trivial bundle. This completes the proof of 4.7. ■

### Immersions

As a final application of 4.5, let us ask which projective spaces can be immersed in the Euclidean space of a given dimension.

If a manifold  $M$  of dimension  $n$  can be immersed in the Euclidean space  $R^{n+k}$  then the Whitney duality theorem

$$w_i(\nu) = \bar{w}_i(M)$$

implies that the dual Stiefel-Whitney classes  $\bar{w}_i(M)$  are zero for  $i > k$ .

As a typical example, consider the real projective space  $P^9$ . Since

$$w(P^9) = (1+a)^{10} = 1 + a^2 + a^8$$

we have

$$\bar{w}(P^9) = 1 + a^2 + a^4 + a^6.$$

Thus if  $P^9$  can be immersed in  $R^{9+k}$ , then  $k$  must be at least 6.

The most striking results for  $P^n$  are obtained when  $n$  is a power of 2. If  $n = 2^r$  then

$$w(P^n) = (1+a)^{n+1} = 1 + a + a^n,$$

hence

$$\bar{w}(P^n) = 1 + a + a^2 + \dots + a^{n-1}.$$

Thus:

**THEOREM 4.8.** *If  $P^{2^r}$  can be immersed in  $R^{2^r+k}$ , then  $k$  must be at least  $2^r - 1$ .*

On the other hand Whitney has proved that every smooth compact manifold of dimension  $n > 1$  can actually be immersed in  $R^{2n-1}$ . (Reference: [Whitney, 1944].) Thus Theorem 4.8 provides a best possible estimate.

Note that estimates for other projective spaces follow from 4.8. For example since  $P^8$  cannot be immersed in  $R^{14}$ , it follows a fortiori that  $P^9$  cannot be immersed in  $R^{14}$ . This duplicates the earlier estimate concerning  $P^9$ . See [James].

An extensive and beautiful theory concerning immersions of manifolds has been developed by S. Smale and M. Hirsch. For further information the reader should consult [Hirsch, 1959] and [Smale, 1959].

### Stiefel-Whitney Numbers

We will now describe a tool which allows us to compare certain Stiefel-Whitney classes of two different manifolds.

Let  $M$  be a closed, possibly disconnected, smooth  $n$ -dimensional manifold. Using mod 2 coefficients, there is a unique *fundamental homology class*

$$\mu_M \in H_n(M; \mathbb{Z}/2).$$

(See Appendix A.) Hence for any cohomology class  $v \in H^n(M; \mathbb{Z}/2)$ , the *Kronecker index*

$$\langle v, \mu_M \rangle \in \mathbb{Z}/2$$

is defined. We will sometimes use the abbreviated notation  $v[M]$  for this Kronecker index.

Let  $r_1, \dots, r_n$  be non-negative integers with  $r_1 + 2r_2 + \dots + nr_n = n$ . Then corresponding to any vector bundle  $\xi$  we can form the monomial

$$w_1(\xi)^{r_1} \dots w_n(\xi)^{r_n}$$

in  $H^n(B(\xi); \mathbb{Z}/2)$ . In particular we can carry out this construction if  $\xi$  is the tangent bundle of the manifold  $M$ .

DEFINITION. The corresponding integer mod 2

$$\langle w_1(\tau_M)^{r_1} \dots w_n(\tau_M)^{r_n}, \mu_M \rangle, \quad \text{or briefly} \quad w_1^{r_1} \dots w_n^{r_n}[M],$$

is called the *Stiefel-Whitney number* of  $M$  associated with the monomial  $w_1^{r_1} \dots w_n^{r_n}$ .

In studying these numbers, we will be interested in the collection of all possible Stiefel-Whitney numbers for a given manifold. Thus two different manifolds  $M$  and  $M'$  have the same Stiefel-Whitney numbers if  $w_1^{r_1} \dots w_n^{r_n}[M] = w_1^{r_1} \dots w_n^{r_n}[M']$  for every monomial  $w_1^{r_1} \dots w_n^{r_n}$  of total dimension  $n$ . (Compare §6.6 and Problem 6-D.)

As an example, let us try to compute the Stiefel-Whitney numbers of the projective space  $P^n$  (which is about the only manifold we are able to handle at this point). Let  $\tau$  denote the tangent bundle of  $P^n$ . If  $n$  is even, then the cohomology class  $w_n(\tau) = (n+1)a^n$  is non-zero, and it follows that the Stiefel-Whitney number  $w_n[P^n]$  is non-zero. Similarly, since  $w_1(\tau) = (n+1)a \neq 0$ , it follows that  $w_1^n[P^n] \neq 0$ . If  $n$  is actually a power of 2, then  $w(\tau) = 1 + a + a^n$ , and it follows that all other Stiefel-Whitney numbers of  $P^n$  are zero. In any case, even if  $n$  is not a power of 2, the remaining Stiefel-Whitney numbers can certainly be computed effectively as products of binomial coefficients.

On the other hand if  $n$  is odd, say  $n = 2k - 1$ , then  $w(\tau) = (1+a)^{2k} = (1+a^2)^k$ , so it follows that  $w_j(\tau) = 0$  whenever  $j$  is odd. Since every monomial of total dimension  $2k - 1$  must contain a factor  $w_j$  of odd dimension, it follows that all of the Stiefel-Whitney numbers of  $P^{2k-1}$  are zero. This gives some indication of how much detail and structure this invariant overlooks.

The importance of Stiefel-Whitney numbers is indicated by the following theorem and its converse.

THEOREM 4.9 [Pontrjagin]. *If  $B$  is a smooth compact  $(n+1)$ -dimensional manifold with boundary equal to  $M$  (compare §17), then the Stiefel-Whitney numbers of  $M$  are all zero.*

*Proof.* Let us denote the fundamental homology class of the pair by

$$\mu_B \in H_{n+1}(B, M),$$

the coefficient group  $\mathbb{Z}/2$  being understood. Then the natural homomorphism

$$\partial: H_{n+1}(B, M) \rightarrow H_n(M)$$

maps  $\mu_B$  to  $\mu_M$ . (Compare Appendix A.) For any class  $v \in H^n(M)$ , note the identity

$$\langle v, \partial\mu_B \rangle = \langle \delta v, \mu_B \rangle,$$

where  $\delta$  denotes the natural homomorphism from  $H^n(M)$  to  $H^{n+1}(B, M)$ . (There is no sign since we are working mod 2.) Consider the tangent bundle  $\tau_B$  restricted to  $M$ , as well as the sub-bundle  $\tau_M$ . Choosing a Euclidean metric on  $\tau_B$ , there is a unique outward normal vector field along  $M$ , spanning a trivial line bundle  $\varepsilon^1$ , and it follows that

$$\tau_B|_M \cong \tau_M \oplus \varepsilon^1.$$

Hence the Stiefel-Whitney classes of  $\tau_B$ , restricted to  $M$ , are precisely equal to the Stiefel-Whitney classes  $w_j$  of  $\tau_M$ . Using the exact sequence

$$H^n(B) \xrightarrow{i^*} H^n(M) \xrightarrow{\delta} H^{n+1}(B, M)$$

where  $i^*$  is the restriction homomorphism, it follows that

$$\delta(w_1^{r_1} \dots w_n^{r_n}) = 0,$$

and therefore

$$\langle w_1^{r_1} \dots w_n^{r_n}, \partial\mu_B \rangle = \langle \delta(w_1^{r_1} \dots w_n^{r_n}), \mu_B \rangle = 0.$$

Thus all Stiefel-Whitney numbers of  $M$  are zero. ■



The converse theorem, due to Thom, is much harder to prove.

**THEOREM 4.10 [Thom].** *If all of the Stiefel-Whitney numbers of  $M$  are zero, then  $M$  can be realized as the boundary of some smooth compact manifold.*

For proof, the reader is referred to [Stong].

For example the union of two disjoint copies of  $M$ , which certainly has all Stiefel-Whitney numbers zero, is equal to the boundary of the cylinder  $M \times [0, 1]$ . Similarly, the odd dimensional projective space  $P^{2k-1}$  has all Stiefel-Whitney numbers zero. The reader may enjoy trying to prove directly that  $P^{2k-1}$  is a boundary.

Now let us introduce the concept of "cobordism class."

**DEFINITION.** Two smooth closed  $n$ -manifolds  $M_1$  and  $M_2$  belong to the same unoriented *cobordism class* iff their disjoint union  $M_1 \cup M_2$  is the boundary of a smooth compact  $(n+1)$ -dimensional manifold.

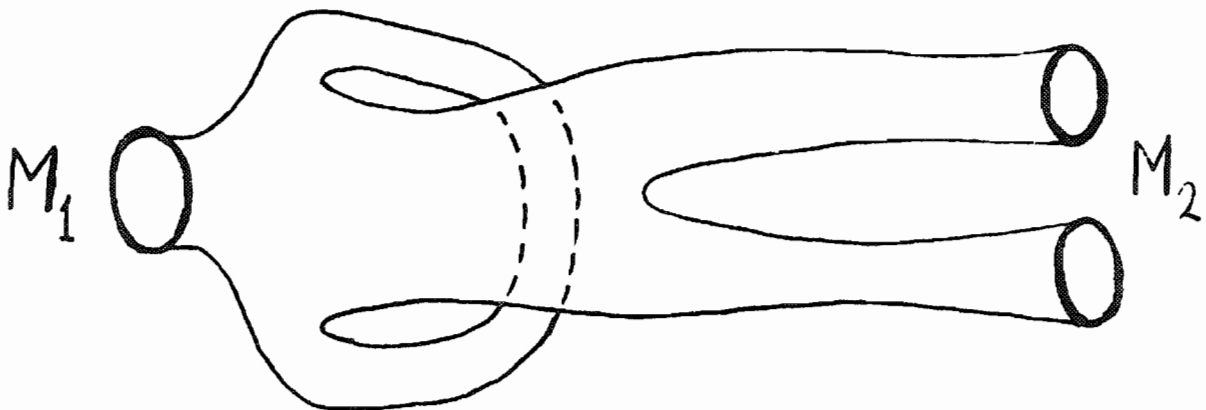

Theorems 4.9 and 4.10 have the following important consequence.

**COROLLARY 4.11.** *Two smooth closed  $n$ -manifolds belong to the same cobordism class if and only if all of their corresponding Stiefel-Whitney numbers are equal.*

The proof is immediate. ■

Here are five problems for the reader.

*Problem 4-A.* Show that the Stiefel-Whitney classes of a Cartesian product are given by

$$w_k(\xi \times \eta) = \sum_{i=0}^k w_i(\xi) \times w_{k-i}(\eta).$$

*Problem 4-B.* Prove the following theorem of Stiefel. If  $n + 1 = 2^r m$  with  $m$  odd, then there do not exist  $2^r$  vector fields on the projective space  $P^n$  which are everywhere linearly independent.\*

*Problem 4-C.* A manifold  $M$  is said to admit a field of tangent  $k$ -planes if its tangent bundle admits a sub-bundle of dimension  $k$ . Show that  $P^n$  admits a field of tangent 1-planes if and only if  $n$  is odd. Show that  $P^4$  and  $P^6$  do not admit fields of tangent 2-planes.

*Problem 4-D.* If the  $n$ -dimensional manifold  $M$  can be immersed in  $R^{n+1}$  show that each  $w_i(M)$  is equal to the  $i$ -fold cup product  $w_1(M)^i$ . If  $P^n$  can be immersed in  $R^{n+1}$  show that  $n$  must be of the form  $2^r - 1$  or  $2^r - 2$ .

*Problem 4-E.* Show that the set  $\mathcal{N}_n$  consisting of all unoriented cobordism classes of smooth closed  $n$ -manifolds can be made into an additive group. This *cobordism group*  $\mathcal{N}_n$  is finite by 4.11, and is clearly a module over  $Z/2$ . Using the manifolds  $P^2 \times P^2$  and  $P^4$ , show that  $\mathcal{N}_4$  contains at least four distinct elements.

---

\* Compare [Stiefel, 1936], [Steenrod and Whitehead], [Adams, 1962].

## §5. Grassmann Manifolds and Universal Bundles

In classical differential geometry one encounters the “spherical image” of a curve  $M^1 \subset \mathbb{R}^{k+1}$ . This is the image of  $M^1$  under the mapping

$$t: M^1 \rightarrow S^k$$

which carries each point of  $M^1$  to its unit tangent vector. Similarly Gauss defined the spherical image of a hypersurface  $M^k \subset \mathbb{R}^{k+1}$  as the image of  $M^k$  under the mapping

$$n: M^k \rightarrow S^k$$

which carries each point of  $M$  to its unit normal vector. (Compare Figures 6, 7.) In order to specify the sign of the tangent or normal vector it is necessary to assume that  $M^1$  or  $M^k$  has a preferred orientation. (Compare §9.) However without this orientation one can still define a corresponding map from the manifold to the real projective space  $P^k$ .

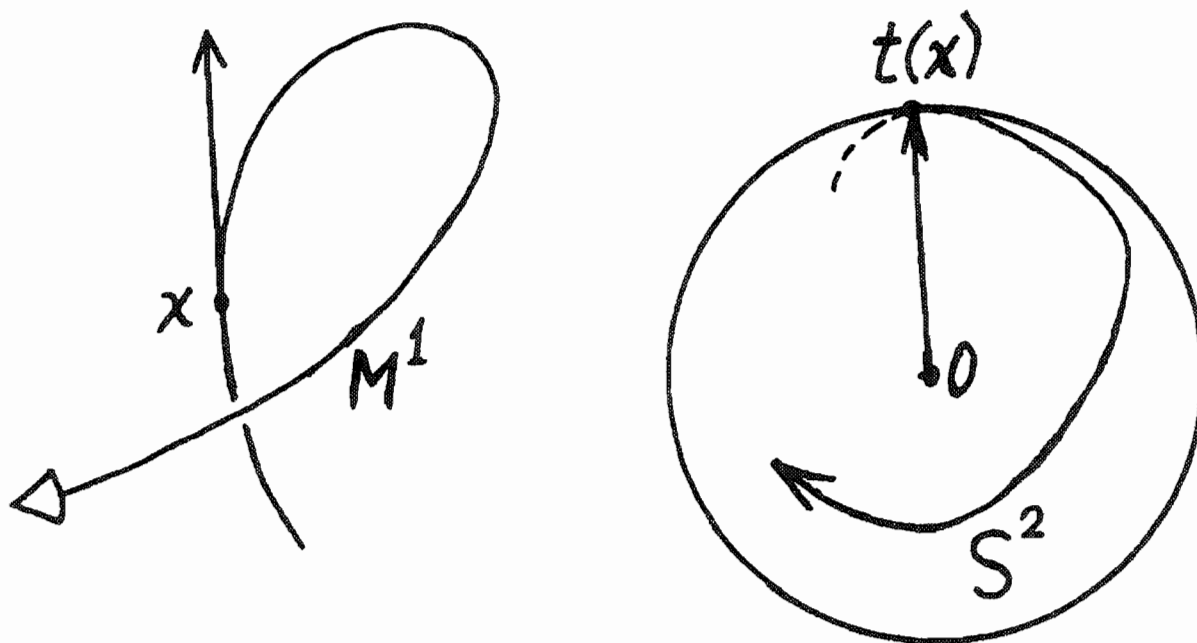

Figure 6

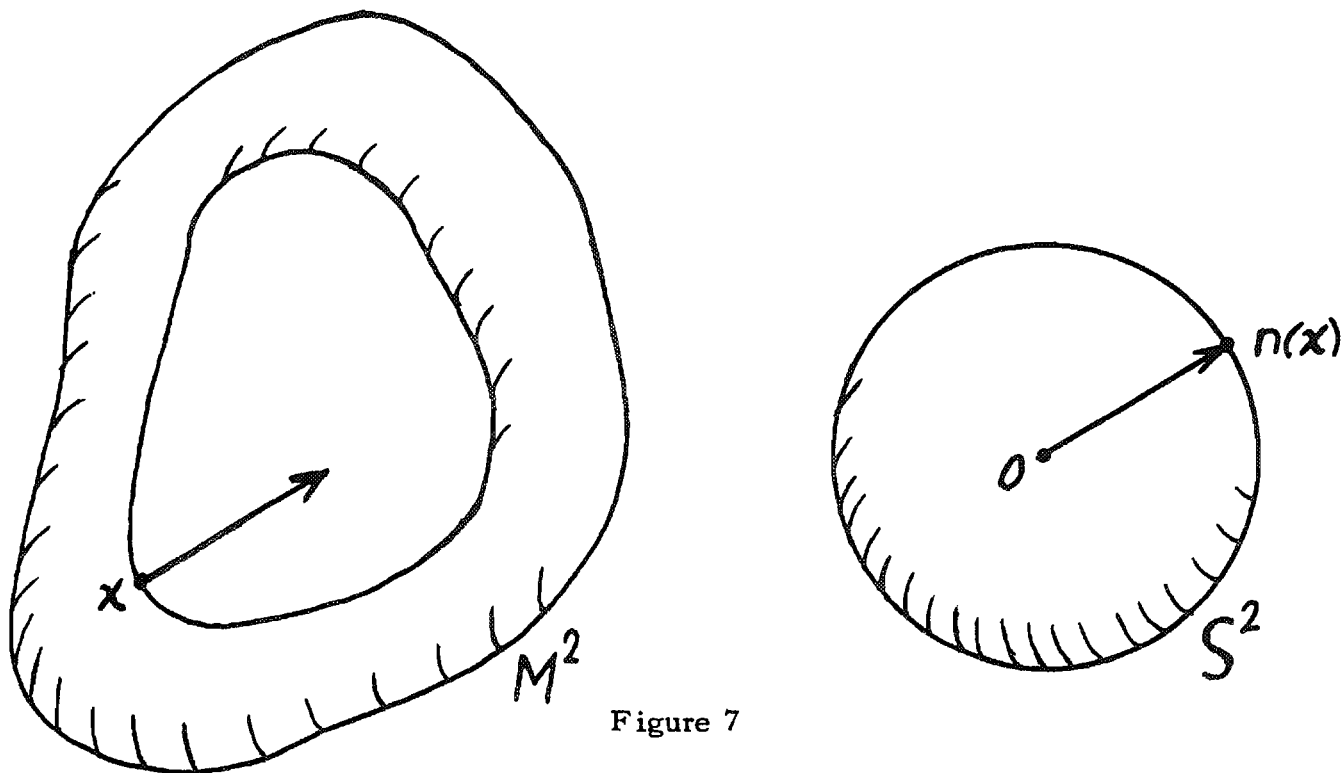

Figure 7

More generally let  $M$  be a smooth manifold of dimension  $n$  in the coordinate space  $\mathbb{R}^{n+k}$ . Then to each point  $x$  of  $M$  one can assign the tangent space  $DM_x \subset \mathbb{R}^{n+k}$ . We will think of  $DM_x$  as determining a point in a new topological space  $G_n(\mathbb{R}^{n+k})$ .

**DEFINITION.** The *Grassmann manifold*  $G_n(\mathbb{R}^{n+k})$  is the set of all  $n$ -dimensional planes through the origin of the coordinate space  $\mathbb{R}^{n+k}$ . This is to be topologized as a quotient space, as follows.

An  $n$ -frame in  $\mathbb{R}^{n+k}$  is an  $n$ -tuple of linearly independent vectors of  $\mathbb{R}^{n+k}$ . The collection of all  $n$ -frames in  $\mathbb{R}^{n+k}$  forms an open subset of the  $n$ -fold Cartesian product  $\mathbb{R}^{n+k} \times \dots \times \mathbb{R}^{n+k}$ , called the *Stiefel manifold*  $V_n(\mathbb{R}^{n+k})$ . (Compare [Steenrod, §7.7].) There is a canonical function

$$q: V_n(\mathbb{R}^{n+k}) \rightarrow G_n(\mathbb{R}^{n+k})$$

which maps each  $n$ -frame to the  $n$ -plane which it spans. Now give  $G_n(\mathbb{R}^{n+k})$  the quotient topology: a subset  $U \subset G_n(\mathbb{R}^{n+k})$  is open if and only if its inverse image  $q^{-1}(U) \subset V_n(\mathbb{R}^{n+k})$  is open.

Alternatively let  $V_n^0(\mathbb{R}^{n+k})$  denote the subset of  $V_n(\mathbb{R}^{n+k})$  consisting of all orthonormal  $n$ -frames. Then  $G_n(\mathbb{R}^{n+k})$  can also be considered

as an identification space of  $V_n^0(\mathbb{R}^{n+k})$ . One sees from the following commutative diagram that both constructions yield the same topology for  $G_n(\mathbb{R}^{n+k})$ .

$$\begin{array}{ccc}
 V_n^0(\mathbb{R}^{n+k}) \subset V_n(\mathbb{R}^{n+k}) & \xrightarrow{\text{Gram-Schmidt process}} & V_n^0(\mathbb{R}^{n+k}) \\
 \searrow q_0 & \downarrow q & \swarrow q_0 \\
 & G_n(\mathbb{R}^{n+k}) &
 \end{array}$$

Here  $q_0$  denotes the restriction of  $q$  to  $V_n^0(\mathbb{R}^{n+k})$ .

LEMMA 5.1. *The Grassmann manifold  $G_n(\mathbb{R}^{n+k})$  is a compact topological manifold\* of dimension  $nk$ . The correspondence  $X \rightarrow X^\perp$ , which assigns to each  $n$ -plane its orthogonal  $k$ -plane, defines a homeomorphism between  $G_n(\mathbb{R}^{n+k})$  and  $G_k(\mathbb{R}^{n+k})$ .*

REMARK. For the special case  $k = 1$  note that  $G_1(\mathbb{R}^{n+1})$  is equal to the real projective space  $P^n$ . It follows that the manifold  $G_n(\mathbb{R}^{n+1})$  of  $n$ -planes in  $(n+1)$ -space is canonically homeomorphic to  $P^n$ .

*Proof of 5.1.* In order to show that  $G_n(\mathbb{R}^{n+k})$  is a Hausdorff space it is sufficient to show that any two points can be separated by a continuous real valued function. For fixed  $w \in \mathbb{R}^{n+k}$ , let  $\rho_w(X)$  denote the square of the Euclidean distance from  $w$  to  $X$ . If  $x_1, \dots, x_n$  is an orthonormal basis for  $X$ , then the identity

$$\rho_w(X) = w \cdot w - (w \cdot x_1)^2 - \dots - (w \cdot x_n)^2$$

shows that the composition

$$V_n^0(\mathbb{R}^{n+k}) \xrightarrow{q_0} G_n(\mathbb{R}^{n+k}) \xrightarrow{\rho_w} \mathbb{R}$$

---

\* A topological manifold of dimension  $d$  is a Hausdorff space in which every point has a neighborhood homeomorphic to  $\mathbb{R}^d$ .

is continuous; hence that  $\rho_w$  is continuous. Now if  $X, Y$  are distinct  $n$ -planes, and  $w$  belongs to  $X$  but not  $Y$ , then  $\rho_w(X) \neq \rho_w(Y)$ . This proves that  $G_n(\mathbb{R}^{n+k})$  is a Hausdorff space.

The set  $V_n^0(\mathbb{R}^{n+k})$  of orthonormal  $n$ -frames is a closed, bounded subset of  $\mathbb{R}^{n+k} \times \dots \times \mathbb{R}^{n+k}$ , and therefore is compact. It follows that

$$G_n(\mathbb{R}^{n+k}) = q_0(V_n^0(\mathbb{R}^{n+k}))$$

is also compact.

*Proof that every point  $X_0$  of  $G_n(\mathbb{R}^{n+k})$  has a neighborhood  $U$  which is homeomorphic to  $\mathbb{R}^{nk}$ .* It will be convenient to regard  $\mathbb{R}^{n+k}$  as the direct sum  $X_0 \oplus X_0^\perp$ . Let  $U$  be the open subset of  $G_n(\mathbb{R}^{n+k})$  consisting of all  $n$ -planes  $Y$  such that the orthogonal projection

$$p: X_0 \oplus X_0^\perp \rightarrow X_0$$

maps  $Y$  onto  $X_0$  (i.e., all  $Y$  such that  $Y \cap X_0^\perp = 0$ ). Then each  $Y \in U$  can be considered as the graph of a linear transformation

$$T(Y): X_0 \rightarrow X_0^\perp.$$

This defines a one-to-one correspondence

$$T: U \rightarrow \text{Hom}(X_0, X_0^\perp) \cong \mathbb{R}^{nk}.$$

We will see that  $T$  is a homeomorphism.

Let  $x_1, \dots, x_n$  be a fixed orthonormal basis for  $X_0$ . Note that each  $n$ -plane  $Y \in U$  has a unique basis  $y_1, \dots, y_n$  such that

$$p(y_1) = x_1, \dots, p(y_n) = x_n.$$

It is easily verified that the  $n$ -frame  $(y_1, \dots, y_n)$  depends continuously on  $Y$ .

Now note the identity

$$y_i = x_i + T(Y)x_i.$$

Since  $y_i$  depends continuously on  $Y$ , it follows that the image  $T(Y)x_i \in X_0^\perp$  depends continuously on  $Y$ . Therefore the linear transformation  $T(Y)$  depends continuously on  $Y$ .

On the other hand this identity shows that the  $n$ -frame  $(y_1, \dots, y_n)$  depends continuously on  $T(Y)$ , and hence that  $Y$  depends continuously on  $T(Y)$ . Thus the function  $T^{-1}$  is also continuous. This completes the proof that  $G_n(\mathbb{R}^{n+k})$  is a manifold.

*Proof that  $Y^\perp$  depends continuously on  $Y$ .* Let  $(\bar{x}_1, \dots, \bar{x}_k)$  be a fixed basis for  $X_0^\perp$ . Define a function

$$f: q^{-1}U \rightarrow V_k(\mathbb{R}^{n+k})$$

as follows. For each  $(y_1, \dots, y_n) \in q^{-1}U$ , apply the Gram-Schmidt process to the vectors  $(y_1, \dots, y_n, \bar{x}_1, \dots, \bar{x}_k)$ ; thus obtaining an orthonormal  $(n+k)$ -frame  $(y'_1, \dots, y'_{n+k})$  with  $y'_{n+1}, \dots, y'_{n+k} \in Y^\perp$ . Setting  $f(y_1, \dots, y_n) = (y'_{n+1}, \dots, y'_{n+k})$ , it follows that the diagram

$$\begin{array}{ccc} q^{-1}U & \xrightarrow{f} & V_k(\mathbb{R}^{n+k}) \\ \downarrow q & & \downarrow q \\ U & \xrightarrow{\perp} & G_k(\mathbb{R}^{n+k}) \end{array}$$

is commutative. Now  $f$  is continuous, so  $q \circ f$  is continuous, therefore the correspondence  $Y \mapsto Y^\perp$  must also be continuous. This completes the proof of 5.1. ■

A canonical vector bundle  $\gamma^n(\mathbb{R}^{n+k})$  over  $G_n(\mathbb{R}^{n+k})$  is constructed as follows. Let

$$E = E(\gamma^n(\mathbb{R}^{n+k}))$$

be the set of all pairs\*

( $n$ -plane in  $\mathbb{R}^{n+k}$ , vector in that  $n$ -plane).

This is to be topologized as a subset of  $G_n(\mathbb{R}^{n+k}) \times \mathbb{R}^{n+k}$ . The projection map  $\pi: E \rightarrow G_n(\mathbb{R}^{n+k})$  is defined by  $\pi(X, x) = X$ , and the vector space structure in the fiber over  $X$  is defined by  $t_1(X, x_1) + t_2(X, x_2) = (X, t_1x_1 + t_2x_2)$ . (Note that  $\gamma^1(\mathbb{R}^{n+1})$  is the same as the line bundle  $\gamma_n^1$  described in §2.)

**LEMMA 5.2.** *The vector bundle  $\gamma^n(\mathbb{R}^{n+k})$  constructed in this way satisfies the local triviality condition.*

*Proof.* Let  $U$  be the neighborhood of  $X_0$  constructed as in 5.1. Define the coordinate homeomorphism

$$h: U \times X_0 \rightarrow \pi^{-1}U$$

as follows. Let  $h(Y, x) = (Y, y)$  where  $y$  denotes the unique vector in  $Y$  which is carried into  $x$  by the orthogonal projection

$$p: \mathbb{R}^{n+k} \rightarrow X_0.$$

The identities

$$h(Y, x) = (Y, x + T(Y)x)$$

and

$$h^{-1}(Y, y) = (Y, py)$$

show that  $h$  and  $h^{-1}$  are continuous. This completes the proof of 5.2. ■

Given a smooth  $n$ -manifold  $M \subset \mathbb{R}^{n+k}$  the *generalized Gauss map*

$$\bar{g}: M \rightarrow G_n(\mathbb{R}^{n+k})$$

---

\* Here, and elsewhere, the expression “ $n$ -plane” means linear subspace of dimension  $n$ . Thus we only consider  $n$ -planes through the origin.



can be defined as the function which carries each  $x \in M$  to its tangent space  $DM_x \in G_n(\mathbb{R}^{n+k})$ . This is covered by a bundle map

$$g: E(\tau_M) \rightarrow E(\gamma^n(\mathbb{R}^{n+k})),$$

where  $g(x, v) = (DM_x, v)$ . We will use the abbreviated notation

$$g: \tau_M \rightarrow \gamma^n(\mathbb{R}^{n+k}).$$

It is clear that both  $g$  and  $\bar{g}$  are continuous.

Not only tangent bundles, but most other  $\mathbb{R}^n$ -bundles can be mapped into the bundle  $\gamma^n(\mathbb{R}^{n+k})$  providing that  $k$  is sufficiently large. For this reason  $\gamma^n(\mathbb{R}^{n+k})$  is called a "universal bundle." (Compare 5.6 and 5.7, as well as [Steenrod, §19].)

**LEMMA 5.3.** *For any  $n$ -plane bundle  $\xi$  over a compact base space  $B$  there exists a bundle map  $\xi \rightarrow \gamma^n(\mathbb{R}^{n+k})$  provided that  $k$  is sufficiently large.*

In order to construct a bundle map  $f: \xi \rightarrow \gamma^n(\mathbb{R}^m)$  it is sufficient to construct a map

$$\hat{f}: E(\xi) \rightarrow \mathbb{R}^m$$

which is linear and injective (i.e., has kernel zero) on each fiber of  $\xi$ . The required function  $f$  can then be defined by

$$f(e) = (\hat{f}(\text{fiber through } e), \hat{f}(e)).$$

The continuity of  $f$  is not difficult to verify, making use of the fact that  $\xi$  is locally trivial.

*Proof of 5.3.* Choose open sets  $U_1, \dots, U_r$  covering  $B$  so that each  $\xi|U_i$  is trivial. Since  $B$  is normal, there exist open sets  $V_1, \dots, V_r$  covering  $B$  with  $\bar{V}_i \subset U_i$ . (Compare [Kelley, p. 171]. Here  $\bar{V}_i$  denotes the closure of  $V_i$ .) Similarly construct  $W_1, \dots, W_r$  with  $\bar{W}_i \subset V_i$ . Let

$$\lambda_i: B \rightarrow \mathbb{R}$$

denote a continuous function which takes the value 1 on  $\bar{W}_i$  and the value 0 outside of  $V_i$ .

Since  $\xi|U_i$  is trivial there exists a map

$$h_i: \pi^{-1}U_i \rightarrow \mathbb{R}^n$$

which maps each fiber of  $\xi|U_i$  linearly onto  $\mathbb{R}^n$ . Define  $h'_i: E(\xi) \rightarrow \mathbb{R}^n$  by

$$\begin{aligned} h'_i(e) &= 0 && \text{for } \pi(e) \notin V_i \\ h'_i(e) &= \lambda_i(\pi(e))h_i(e) && \text{for } \pi(e) \in U_i. \end{aligned}$$

Evidently  $h'_i$  is continuous, and is linear on each fiber. Now define

$$\hat{f}: E(\xi) \rightarrow \mathbb{R}^n \oplus \dots \oplus \mathbb{R}^n \cong \mathbb{R}^{rn}$$

by  $\hat{f}(e) = (h'_1(e), h'_2(e), \dots, h'_r(e))$ . Then  $\hat{f}$  is also continuous and maps each fiber injectively. This completes the proof of 5.3. ■

### Infinite Grassmann Manifolds

A similar argument applies if the base space  $B$  is paracompact and finite dimensional. (Compare Problem 5-E.) However in order to take care of bundles over more exotic base spaces it is necessary to allow the dimension of  $\mathbb{R}^{n+k}$  to tend to infinity, thus yielding an infinite Grassmann "manifold"  $G_n(\mathbb{R}^\infty)$ .

Let  $\mathbb{R}^\infty$  denote the vector space consisting of those infinite sequences

$$x = (x_1, x_2, x_3, \dots)$$

of real numbers for which all but a finite number of the  $x_i$  are zero. (Thus  $\mathbb{R}^\infty$  is much smaller than the infinite coordinate spaces utilized in §1.)

For fixed  $k$ , the subspace consisting of all

$$x = (x_1, x_2, \dots, x_k, 0, 0, \dots)$$

will be identified with the coordinate space  $\mathbb{R}^k$ . Thus  $\mathbb{R}^1 \subset \mathbb{R}^2 \subset \mathbb{R}^3 \subset \dots$  with union  $\mathbb{R}^\infty$ .

DEFINITION. The *infinite Grassmann manifold*

$$G_n = G_n(\mathbb{R}^\infty)$$

is the set of all  $n$ -dimensional linear sub-spaces of  $\mathbb{R}^\infty$ , topologized as the direct limit\* of the sequence

$$G_n(\mathbb{R}^n) \subset G_n(\mathbb{R}^{n+1}) \subset G_n(\mathbb{R}^{n+2}) \subset \dots$$

In other words, a subset of  $G_n$  is open [or closed] if and only if its intersection with  $G_n(\mathbb{R}^{n+k})$  is open [or closed] as a subset of  $G_n(\mathbb{R}^{n+k})$  for each  $k$ . This makes sense since  $G_n(\mathbb{R}^\infty)$  is equal to the union of the subsets  $G_n(\mathbb{R}^{n+k})$ .

As a special case, the *infinite projective space*  $P^\infty = G_1(\mathbb{R}^\infty)$  is equal to the direct limit of the sequence  $P^1 \subset P^2 \subset P^3 \subset \dots$ .

Similarly  $\mathbb{R}^\infty$  itself can be topologized as the direct limit of the sequence  $\mathbb{R}^1 \subset \mathbb{R}^2 \subset \dots$ .

The Universal Bundle  $\gamma^n$

A canonical bundle  $\gamma^n$  over  $G_n$  is constructed, just as in the finite dimensional case, as follows. Let

$$E(\gamma^n) \subset G_n \times \mathbb{R}^\infty$$

be the set of all pairs

$$(n\text{-plane in } \mathbb{R}^\infty, \text{ vector in that } n\text{-plane}),$$

topologized as a subset of the Cartesian product. Define  $\pi: E(\gamma^n) \rightarrow G_n$  by  $\pi(X, x) = X$ , and define the vector space structures in the fibers as before.

---

\* It is customary in algebraic topology to call this the "weak topology," a weak topology being one with many open sets. This usage is unfortunate since analysts use the term weak topology with precisely the opposite meaning. On the other hand the terms "fine topology" or "large topology" or "Whitehead topology" are certainly acceptable.

LEMMA 5.4. *This vector bundle  $\gamma^n$  satisfies the local triviality condition.*

The proof will be essentially the same as that of 5.2. However the following technical lemma will be needed. (Compare [J. H. C. Whitehead, 1961, §18.5].)

LEMMA 5.5. *Let  $A_1 \subset A_2 \subset \dots$  and  $B_1 \subset B_2 \subset \dots$  be sequences of locally compact spaces with direct limits  $A$  and  $B$  respectively. Then the Cartesian product topology on  $A \times B$  coincides with the direct limit topology which is associated with the sequence  $A_1 \times B_1 \subset A_2 \times B_2 \subset \dots$ .*

*Proof.* Let  $W$  be open in the direct limit topology, and let  $(a, b)$  be any point of  $W$ . Suppose that  $(a, b) \in A_i \times B_i$ . Choose a compact neighborhood  $K_i$  of  $a$  in  $A_i$  and a compact neighborhood  $L_i$  of  $b$  in  $B_i$  so that  $K_i \times L_i \subset W$ . It is now possible (with some effort) to choose compact neighborhoods  $K_{i+1}$  of  $K_i$  in  $A_{i+1}$  and  $L_{i+1}$  of  $L_i$  in  $B_{i+1}$  so that  $K_{i+1} \times L_{i+1} \subset W$ . Continue by induction, constructing neighborhoods  $K_i \subset K_{i+1} \subset K_{i+2} \subset \dots$  with union  $U$  and  $L_i \subset L_{i+1} \subset \dots$  with union  $V$ . Then  $U$  and  $V$  are open sets, and

$$(a, b) \in U \times V \subset W.$$

Thus  $W$  is open in the product topology, which completes the proof of 5.5. ■

*Proof of Lemma 5.4.* Let  $X_0 \subset \mathbb{R}^\infty$  be a fixed  $n$ -plane, and let  $U \subset G_n$  be the set of all  $n$ -planes  $Y$  which project *onto*  $X_0$  under the orthogonal projection  $p: \mathbb{R}^\infty \rightarrow X_0$ . This set  $U$  is open since, for each finite  $k$ , the intersection

$$U_k = U \cap G_n(\mathbb{R}^{n+k})$$

is known to be an open set. Defining

$$h : U \times X_0 \rightarrow \pi^{-1} U$$

as in 5.2, it follows from 5.2, that  $h|_{U_k \times X_0}$  is continuous for each  $k$ . Now Lemma 5.5 implies that  $h$  itself is continuous.

As before, the identity  $h^{-1}(Y, y) = (Y, py)$  implies that  $h^{-1}$  is continuous. Thus  $h$  is a homeomorphism. This completes the proof that  $\gamma^n$  is locally trivial. ■

The following two theorems assert that this bundle  $\gamma^n$  over  $G_n$  is a "universal"  $\mathbb{R}^n$ -bundle.

**THEOREM 5.6.** *Any  $\mathbb{R}^n$ -bundle  $\xi$  over a paracompact base space admits a bundle map  $\xi \rightarrow \gamma^n$ .*

Two bundle maps,  $f, g : \xi \rightarrow \gamma^n$  are called *bundle-homotopic* if there exists a one-parameter family of bundle maps

$$h_t : \xi \rightarrow \gamma^n, \quad 0 \leq t \leq 1,$$

with  $h_0 = f$ ,  $h_1 = g$ , such that  $h$  is continuous as a function of both variables. In other words the associated function

$$h : E(\xi) \times [0, 1] \rightarrow E(\gamma^n)$$

must be continuous.

**THEOREM 5.7.** *Any two bundle maps from an  $\mathbb{R}^n$ -bundle to  $\gamma^n$  are bundle-homotopic.*

### 5.8. Paracompact Spaces

Before beginning the proof of 5.6 and 5.7, let us review the definition and the basic theorems concerning paracompactness. For further information the reader is referred to [Kelley] or [Dugundji].

**DEFINITION.** A topological space  $B$  is *paracompact* if  $B$  is a Hausdorff space and if, for every open covering  $\{U_\alpha\}$  of  $B$ , there exists an open covering  $\{V_\beta\}$  which

- 1) is a *refinement* of  $\{U_\alpha\}$ : that is each  $V_\beta$  is contained in some  $U_\alpha$ , and
- 2) is *locally finite*: that is each point of  $B$  has a neighborhood which intersects only finitely many of the  $V_\beta$ .

Nearly all familiar topological spaces are paracompact. For example (see the above references):

**THEOREM OF A. H. Stone.** *Every metric space is paracompact.*

**THEOREM OF Morita.** *If a regular topological space is the countable union of compact subsets, then it is paracompact.*

**COROLLARY.** *The direct limit of a sequence  $K_1 \subset K_2 \subset K_3 \subset \dots$  of compact spaces is paracompact. In particular the infinite Grassmann space  $G_n$  is paracompact.*

For it follows from [Whitehead, 1961, §18.4] that such a direct limit is regular. (The reader should have no difficulty in supplying a proof.)

**THEOREM OF Dieudonné.** *Every paracompact space is normal.*

The proof of 5.6 will be based on the following.

**LEMMA 5.9.** *For any fiber bundle  $\xi$  over a paracompact space  $B$ , there exists a locally finite covering of  $B$  by countably many open sets  $U_1, U_2, U_3, \dots$ , so that  $\xi|U_i$  is trivial for each  $i$ .*

*Proof.* Choose a locally finite open covering  $\{V_\alpha\}$  so that each  $\xi|V_\alpha$  is trivial; and choose an open covering  $\{W_\alpha\}$  with  $\bar{W}_\alpha \subset V_\alpha$  for each  $\alpha$ . (Compare [Kelley, p. 171].) Let  $\lambda_\alpha: B \rightarrow \mathbb{R}$  be a continuous function which takes the value 1 on  $\bar{W}_\alpha$  and the value 0 outside of  $V_\alpha$ . For each non-vacuous finite subset  $S$  of the index set  $\{\alpha\}$ , let  $U(S) \subset B$  denote the set of all  $b \in B$  for which

$$\min_{\alpha \in S} \lambda_\alpha(b) > \max_{\alpha \notin S} \lambda_\alpha(b).$$

Let  $U_k$  be the union of those sets  $U(S)$  for which  $S$  has precisely  $k$  elements.

Clearly each  $U_k$  is an open set, and

$$B = U_1 \cup U_2 \cup U_3 \cup \dots$$

For, given  $b \in B$ , if precisely  $k$  of the numbers  $\lambda_\alpha(b)$  are positive, then  $b \in U_k$ . If  $\alpha$  is any element of the set  $S$ , note that

$$U(S) \subset V_\alpha.$$

Since the covering  $\{V_\alpha\}$  is locally finite, it follows that  $\{U_k\}$  is locally finite. Furthermore, since each  $\xi|V_\alpha$  is trivial, it follows that each  $\xi|U(S)$  is trivial. But the set  $U_k$  is equal to the disjoint union of its open subsets  $U(S)$ . Therefore  $\xi|U_k$  is also trivial. ■

The bundle map  $f: \xi \rightarrow \gamma^n$  can now be constructed just as in the proof of 5.3. Details will be left to the reader. This proves 5.6. ■

*Proof of Theorem 5.7.* Any bundle map  $f: \xi \rightarrow \gamma^n$  determines a map

$$\hat{f}: E(\xi) \rightarrow \mathbb{R}^\infty$$

whose restriction to each fiber of  $\xi$  is linear and injective. Conversely  $\hat{f}$  determines  $f$  by the identity

$$f(e) = (\hat{f}(\text{fiber through } e), \hat{f}(e)).$$

Let  $f, g: \xi \rightarrow \gamma^n$  be any two bundle maps.

Case 1. Suppose that the vector  $\hat{f}(e) \in \mathbb{R}^\infty$  is never equal to a negative multiple of  $\hat{g}(e)$  for  $e \neq 0, e \in E(\xi)$ . Then the formula

$$\hat{h}_t(e) = (1-t)\hat{f}(e) + t\hat{g}(e), \quad 0 \leq t \leq 1,$$

defines a homotopy between  $\hat{f}$  and  $\hat{g}$ . To prove that  $\hat{h}$  is continuous as a function of both variables, it is only necessary to prove that the vector space operations in  $\mathbb{R}^\infty$  (i.e., addition, and multiplication by scalars)

are continuous. But this follows easily from Lemma 5.5. Evidently  $\hat{h}_t(e) \neq 0$  if  $e$  is a non-zero vector of  $E(\xi)$ . Hence we can define  $h: E(\xi) \times [0, 1] \rightarrow E(\eta)$  by

$$h_t(e) = (\hat{h}_t(\text{fiber through } e), \hat{h}_t(e)).$$

To prove that  $h$  is continuous, it is sufficient to prove that the corresponding function

$$\bar{h}: B(\xi) \times [0, 1] \rightarrow G_n$$

on the base space is continuous. Let  $U$  be an open subset of  $B(\xi)$  with  $\xi|U$  trivial, and let  $s_1, \dots, s_n$  be nowhere dependent cross-sections of  $\xi|U$ . Then  $\bar{h}|U \times [0, 1]$  can be considered as the composition of

- 1) a continuous function  $b, t \mapsto (\hat{h}_t s_1(b), \dots, \hat{h}_t s_n(b))$  from  $U \times [0, 1]$  to the "infinite Stiefel manifold"  $V_n(\mathbb{R}^\infty) \subset \mathbb{R}^\infty \times \dots \times \mathbb{R}^\infty$ , and
- 2) the canonical projection  $q: V_n(\mathbb{R}^\infty) \rightarrow G_n$ .

Using 5.5 it is seen that  $q$  is continuous. Therefore  $\bar{h}$  is continuous; hence the bundle-homotopy  $h$  between  $f$  and  $g$  is continuous.

*General Case.* Let  $f, g: \xi \rightarrow \gamma^n$  be arbitrary bundle maps. A bundle map

$$d_1: \gamma^n \rightarrow \gamma^n$$

is induced by the linear transformation  $\mathbb{R}^\infty \rightarrow \mathbb{R}^\infty$  which carries the  $i$ -th basis vector of  $\mathbb{R}^\infty$  to the  $(2i-1)$ -th. Similarly  $d_2: \gamma^n \rightarrow \gamma^n$  is induced by the linear transformation which carries the  $i$ -th basis vector to the  $2i$ -th. Now note that three bundle-homotopies

$$f \sim d_1 \circ f \sim d_2 \circ g \sim g$$

are given by three applications of Case 1. Hence  $f \sim g$ . ■

### Characteristic Classes of Real $n$ -Plane Bundles

Using 5.6 and 5.7, it is possible to give a precise definition of the concept of characteristic class. First observe the following.



COROLLARY 5.10. Any  $\mathbb{R}^n$ -bundle  $\xi$  over a paracompact space  $B$  determines a unique homotopy class of maps

$$\bar{f}_\xi: B \rightarrow G_n.$$

*Proof.* Let  $f_\xi: \xi \rightarrow \gamma^n$  be any bundle map, and let  $\bar{f}_\xi$  be the induced map of base spaces. ■

Now let  $\Lambda$  be a coefficient group or ring and let

$$c \in H^i(G_n; \Lambda)$$

be any cohomology class. Then  $\xi$  and  $c$  together determine a cohomology class

$$\bar{f}_\xi^* c \in H^i(B; \Lambda).$$

This class will be denoted briefly by  $c(\xi)$ .

DEFINITION.  $c(\xi)$  is called the *characteristic cohomology class* of  $\xi$  determined by  $c$ .

Note that the correspondence  $\xi \mapsto c(\xi)$  is natural with respect to bundle maps. (Compare Axiom 2 in §4). Conversely, given any correspondence

$$\xi \mapsto c(\xi) \in H^i(B(\xi); \Lambda)$$

which is natural with respect to bundle maps, we have

$$c(\xi) = \bar{f}_\xi^* c(\gamma^n).$$

Thus the above construction is the most general one. Briefly speaking: *The ring consisting of all characteristic cohomology classes for  $\mathbb{R}^n$ -bundles over paracompact base spaces with coefficient ring  $\Lambda$  is canonically isomorphic to the cohomology ring  $H^*(G_n; \Lambda)$ .*

These constructions emphasize the importance of computing the cohomology of the space  $G_n$ . The next two sections will give one procedure for computing this cohomology, at least modulo 2.

REMARK. Using the “covering homotopy theorem” (compare [Dold], [Husemoller]), Corollary 5.10 can be sharpened as follows: Two  $\mathbb{R}^n$ -bundles  $\xi$  and  $\eta$  over the paracompact space  $B$  are isomorphic if and only if the mapping  $\bar{f}_\xi$  of 5.10 is homotopic to  $\bar{f}_\eta$ .

Here are five problems for the reader.

*Problem 5-A.* Show that the Grassmann manifold  $G_n(\mathbb{R}^{n+k})$  can be made into a smooth manifold as follows: a function  $f: G_n(\mathbb{R}^{n+k}) \rightarrow \mathbb{R}$  belongs to the collection  $F$  of smooth real valued functions if and only if  $f \circ q: V_n(\mathbb{R}^{n+k}) \rightarrow \mathbb{R}$  is smooth.

*Problem 5-B.* Show that the tangent bundle of  $G_n(\mathbb{R}^{n+k})$  is isomorphic to  $\text{Hom}(\gamma^n(\mathbb{R}^{n+k}), \gamma^\perp)$ ; where  $\gamma^\perp$  denotes the orthogonal complement of  $\gamma^n(\mathbb{R}^{n+k})$  in  $\varepsilon^{n+k}$ . Now consider a smooth manifold  $M \subset \mathbb{R}^{n+k}$ . If  $\bar{g}: M \rightarrow G_n(\mathbb{R}^{n+k})$  denotes the generalized Gauss map, show that

$$D\bar{g}: DM \rightarrow DG_n(\mathbb{R}^{n+k})$$

gives rise to a cross-section of the bundle

$$\text{Hom}(\tau_M, \text{Hom}(\tau_M, \nu)) \cong \text{Hom}(\tau_M \otimes \tau_M, \nu).$$

(This cross-section is called the “second fundamental form” of  $M$ .)

*Problem 5-C.* Show that  $G_n(\mathbb{R}^m)$  is diffeomorphic to the smooth manifold consisting of all  $m \times m$  symmetric, idempotent matrices of trace  $n$ . Alternatively show that the map

$$(x_1, \dots, x_n) \mapsto x_1 \wedge \dots \wedge x_n$$

from  $V_n(\mathbb{R}^m)$  to the exterior power  $\Lambda^n(\mathbb{R}^m)$  gives rise to a smooth embedding of  $G_n(\mathbb{R}^m)$  in the projective space  $G_1(\Lambda^n(\mathbb{R}^m)) \cong P^{\binom{m}{n}-1}$ . (Compare van der Waerden, Einführung in die algebraische Geometrie, Springer 1939, §7.)

*Problem 5-D.* Show that  $G_n(\mathbb{R}^{n+k})$  has the following symmetry property. Given any two  $n$ -planes  $X, Y \subset \mathbb{R}^{n+k}$  there exists an orthogonal automorphism of  $\mathbb{R}^{n+k}$  which interchanges  $X$  and  $Y$ . [Whitehead, 1961] defines the angle  $\alpha(X, Y)$  between  $n$ -planes as the maximum over all unit vectors  $x \in X$  of the angle between  $x$  and  $Y$ . Show that  $\alpha$  is a metric for the topological space  $G_n(\mathbb{R}^{n+k})$  and show that

$$\alpha(X, Y) = \alpha(Y^\perp, X^\perp).$$

*Problem 5-E.* Let  $\xi$  be an  $\mathbb{R}^n$ -bundle over  $B$ .

- 1) Show that there exists a vector bundle  $\eta$  over  $B$  with  $\xi \oplus \eta$  trivial if and only if there exists a bundle map

$$\xi \rightarrow \gamma^n(\mathbb{R}^{n+k})$$

for large  $k$ . If such a map exists,  $\xi$  will be called a bundle of *finite type*.

- 2) Now assume that  $B$  is normal. Show that  $\xi$  has finite type if and only if  $B$  is covered by finitely many open sets  $U_1, \dots, U_r$  with  $\xi|_{U_i}$  trivial.
- 3) If  $B$  is paracompact and has finite covering dimension, show (using the argument of 5.9) that every  $\xi$  over  $B$  has finite type.
- 4) Using Stiefel-Whitney classes, show that the vector bundle  $\gamma^1$  over  $P^\infty$  does not have finite type.

## §6. A Cell Structure for Grassmann Manifolds

This section will describe a canonical cell subdivision, due to [Ehresmann], which makes the infinite Grassmann manifold  $G_n(\mathbb{R}^\infty)$  into a CW-complex. Each finite Grassmann manifold  $G_n(\mathbb{R}^{n+k})$  appears as a finite subcomplex. This cell structure has been used by [Pontrjagin] and by [Chern] as a basis for the theory of characteristic classes. The reader should consult these sources, as well as [Wu] for further information. For a thorough treatment of cell complexes in general, consult [Lundell and Weingram]. Grassmann manifolds appear there on p. 17.

First recall some definitions. Let  $D^p$  denote the *unit disk* in  $\mathbb{R}^p$ , consisting of all vectors  $v$  with  $|v| \leq 1$ . The *interior* of  $D^p$  is defined to be the subset consisting of all  $v$  with  $|v| < 1$ . For the special case  $p = 0$ , both  $D^p$  and its interior consist of a single point.

Any space homeomorphic to  $D^p$  is called a *closed p-cell*; and any space homeomorphic to the interior of  $D^p$  is called an *open p-cell*. For example  $\mathbb{R}^p$  is an open p-cell.

6.1 DEFINITION [J. H. C. Whitehead, 1949]. A *CW-complex* consists of a Hausdorff space  $K$ , called the *underlying space*, together with a partition of  $K$  into a collection  $\{e_\alpha\}$  of disjoint subsets, such that four conditions are satisfied.

1) Each  $e_\alpha$  is topologically an open cell of dimension  $n(\alpha) \geq 0$ . Furthermore for each cell  $e_\alpha$  there exists a continuous map

$$f: D^{n(\alpha)} \rightarrow K$$

which carries the interior of the disk  $D^{n(\alpha)}$  homeomorphically onto  $e_\alpha$ . (This  $f$  is called a *characteristic map* for the cell  $e_\alpha$ .)

2) Each point  $x$  which belongs to the closure  $\bar{e}_\alpha$ , but not to  $e_\alpha$  itself, must lie in a cell  $e_\beta$  of lower dimension.

If the complex is *finite* (i.e., if there are only finitely many  $e_\alpha$ ), then these two conditions suffice. However in general two further conditions are needed. A subset of  $K$  is called a [finite] *subcomplex* if it is a closed set and is a union of [finitely many]  $e_\alpha$ 's.

3) *Closure finiteness*. Each point of  $K$  is contained in a finite subcomplex.

4) *Whitehead topology*.  $K$  is topologized as the direct limit of its finite subcomplexes. I.e., a subset of  $K$  is closed if and only if its intersection with each finite subcomplex is closed.

Note that the closure  $\bar{e}_\alpha$  of a cell of  $K$  need not be a cell. For example the sphere  $S^n$  can be considered as a CW-complex with one 0-cell and one  $n$ -cell. In this case the closure of the  $n$ -cell is equal to the entire sphere.

A theorem of [Miyazaki] asserts that every CW-complex is paracompact. (Compare [Dugundji, p. 419].)

The cell structure for the Grassmann manifold  $G_n(\mathbb{R}^m)$  is obtained as follows. Recall that  $\mathbb{R}^m$  contains subspaces

$$\mathbb{R}^0 \subset \mathbb{R}^1 \subset \mathbb{R}^2 \subset \dots \subset \mathbb{R}^m ;$$

where  $\mathbb{R}^k$  consists of all vectors of the form  $v = (v_1, \dots, v_k, 0, \dots, 0)$ . Any  $n$ -plane  $X \subset \mathbb{R}^m$  gives rise to a sequence of integers

$$0 \leq \dim(X \cap \mathbb{R}^1) \leq \dim(X \cap \mathbb{R}^2) \leq \dots \leq \dim(X \cap \mathbb{R}^m) = n .$$

Two consecutive integers in this sequence differ by at most 1. This fact is proved by inspecting the exact sequence

$$0 \rightarrow X \cap \mathbb{R}^{k-1} \rightarrow X \cap \mathbb{R}^k \xrightarrow{\text{k-th coordinate}} \mathbb{R} .$$

Thus the above sequence of integers contains precisely  $n$  "jumps."

By a *Schubert symbol*  $\sigma = (\sigma_1, \dots, \sigma_n)$  is meant a sequence of  $n$  integers satisfying

$$1 \leq \sigma_1 < \sigma_2 < \dots < \sigma_n \leq m .$$

For each Schubert symbol  $\sigma$ , let  $e(\sigma) \subset G_n(\mathbb{R}^m)$  denote the set of all  $n$ -planes  $X$  such that

$$\dim (X \cap \mathbb{R}^{\sigma_i}) = i, \dim (X \cap \mathbb{R}^{\sigma_{i-1}}) = i-1$$

for  $i = 1, \dots, n$ . Evidently each  $X \in G_n(\mathbb{R}^m)$  belongs to precisely one of the sets  $e(\sigma)$ . We will see presently that  $e(\sigma)$  is an open cell\* of dimension  $d(\sigma) = (\sigma_1-1) + (\sigma_2-2) + \dots + (\sigma_n-n)$ .

Let  $H^k \subset \mathbb{R}^k$  denote the open half-space consisting of all  $x = (\xi_1, \dots, \xi_k, 0, \dots, 0)$  with  $\xi_k > 0$ . Note that an  $n$ -plane  $X$  belongs to  $e(\sigma)$  if and only if it possesses a basis  $x_1, \dots, x_n$  so that

$$x_1 \in H^{\sigma_1}, \dots, x_n \in H^{\sigma_n} .$$

For if  $X$  possesses such a basis, then the exact sequence above shows that

$$\dim (X \cap \mathbb{R}^{\sigma_i}) > \dim (X \cap \mathbb{R}^{\sigma_{i-1}})$$

for  $i = 1, \dots, n$ , hence  $X \in e(\sigma)$ . The converse is proved similarly. In terms of matrices, the  $n$ -plane  $X$  belongs to  $e(\sigma)$  if and only if it can be described as the row space of an  $n \times m$  matrix  $[x_{ij}]$  of the form

$$\left[ \begin{array}{cccccccc} * & \dots & *10 & \dots & 000 & \dots & 000 & \dots & 0 \\ * & \dots & *** & \dots & *10 & \dots & 000 & \dots & 0 \\ \vdots & & \vdots & & \vdots & & \vdots & & \vdots \\ \vdots & & \vdots & & \vdots & & \vdots & & \vdots \\ * & \dots & *** & \dots & *** & \dots & *10 & \dots & 0 \end{array} \right]$$

\* The closure  $\bar{e}(\sigma)$  is called a *Schubert variety*. (Compare [Schubert].) In the notation of Chern and Wu, the cell  $e(\sigma)$  is indexed not by the sequence  $\sigma = (\sigma_1, \dots, \sigma_n)$  but rather by the modified sequence  $(\sigma_1-1, \sigma_2-2, \dots, \sigma_n-n)$ , which is more convenient to use for many purposes.

where the  $i$ -th row has  $\sigma_i$ -th entry positive (say equal to 1), and all subsequent entries zero.

LEMMA 6.2. *Each  $n$ -plane  $X \in e(\sigma)$  possesses a unique orthonormal basis  $(x_1, \dots, x_n)$  which belongs to  $H^{\sigma_1} \times \dots \times H^{\sigma_n}$ .*

*Proof.* The vector  $x_1$  is required to lie in the 1-dimensional vector space  $X \cap \mathbb{R}^{\sigma_1}$ , and to be a unit vector. This leaves only two possibilities for  $x_1$ , and the condition that the  $\sigma_1$ -th coordinate be positive specifies one of these two. Now  $x_2$  is required to be a unit vector in the 2-dimensional space  $X \cap \mathbb{R}^{\sigma_2}$ , and to be orthogonal to  $x_1$ . Again this leaves two possibilities, and the condition that the  $\sigma_2$ -th coordinate be positive specifies one of these two. Continuing by induction, it follows that  $x_3, x_4, \dots, x_n$  are also uniquely determined.

DEFINITION. Let  $e'(\sigma) = V_n^0(\mathbb{R}^m) \cap (H^{\sigma_1} \times \dots \times H^{\sigma_n})$  denote the set of all orthonormal  $n$ -frames  $(x_1, \dots, x_n)$  such that each  $x_i$  belongs to the open half-space  $H^{\sigma_i}$ . Let  $\bar{e}'(\sigma)$  denote the set of orthonormal frames  $(x_1, \dots, x_n)$  such that each  $x_i$  belongs to the closure  $\bar{H}^{\sigma_i}$ .

LEMMA 6.3. *The set  $\bar{e}'(\sigma)$  is topologically a closed cell of dimension  $d(\sigma) = (\sigma_1 - 1) + (\sigma_2 - 2) + \dots + (\sigma_n - n)$ , with interior  $e'(\sigma)$ . Furthermore  $q$  maps the interior  $e'(\sigma)$  homeomorphically onto  $e(\sigma)$ .*

Thus  $e(\sigma)$  is actually an open cell of dimension  $d(\sigma)$ . Furthermore the map

$$q|_{\bar{e}'(\sigma)} : \bar{e}'(\sigma) \rightarrow G_n(\mathbb{R}^m)$$

will serve as a characteristic map for this cell.

The proof of 6.3 will be by induction on  $n$ . For  $n = 1$  the set  $\bar{e}'(\sigma_1)$  consists of all vectors

$$x_1 = (x_{11}, x_{12}, \dots, x_{1\sigma_1}, 0, \dots, 0)$$

with  $\sum x_{1i}^2 = 1$ ,  $x_{1\sigma_1} \geq 0$ . Evidently  $\bar{e}'(\sigma_1)$  is a closed hemisphere of dimension  $\sigma_1 - 1$ , and therefore is homeomorphic to the disk  $D^{\sigma_1 - 1}$ .

Given unit vectors  $u, v \in \mathbb{R}^m$  with  $u \neq -v$ , let  $T(u, v)$  denote the unique rotation of  $\mathbb{R}^m$  which carries  $u$  to  $v$ , and leaves everything orthogonal to  $u$  and  $v$  fixed. Thus  $T(u, u)$  is the identity map and  $T(v, u) = T(u, v)^{-1}$ . Alternatively  $T(u, v)$  can be defined by the formula

$$T(u, v)x = x - \frac{(u+v) \cdot x}{1+u \cdot v} (u+v) + 2(u \cdot x)v .$$

In fact the function  $T(u, v)$  defined in this way is linear in  $x$ , and has the correct effect on the vectors  $u, v$ , and on all vectors orthogonal to  $u$  and  $v$ . It follows from this formula that:

- 1)  $T(u, v)x$  is continuous as a function of three variables; and
- 2) if  $u, v \in \mathbb{R}^k$  then  $T(u, v)x \equiv x$  (modulo  $\mathbb{R}^k$ ).

Let  $b_i \in H^{\sigma_i}$  denote the vector with  $\sigma_i$ -th coordinate equal to 1, and all other coordinates zero. Thus  $(b_1, \dots, b_n) \in e'(\sigma)$ . For any  $n$ -frame  $(x_1, \dots, x_n) \in \bar{e}'(\sigma)$  consider the rotation

$$T = T(b_n, x_n) \circ T(b_{n-1}, x_{n-1}) \circ \dots \circ T(b_1, x_1)$$

of  $\mathbb{R}^m$ . This rotation carries the  $n$  vectors  $b_1, \dots, b_n$  to the vectors  $x_1, \dots, x_n$  respectively. In fact the rotations  $T(b_1, x_1), \dots, T(b_{i-1}, x_{i-1})$  leave  $b_i$  fixed (since  $b_i \cdot b_j = b_i \cdot x_j = 0$  for  $i > j$ ); the rotation  $T(b_i, x_i)$  carries  $b_i$  to  $x_i$ ; and the rotations  $T(b_{i+1}, x_{i+1}), \dots, T(b_n, x_n)$  leave  $x_i$  fixed.

Given an integer  $\sigma_{n+1} > \sigma_n$  let  $D$  denote the set of all unit vectors  $u \in \bar{H}^{\sigma_{n+1}}$  with

$$b_1 \cdot u = \dots = b_n \cdot u = 0 .$$

Evidently  $D$  is a closed hemisphere of dimension  $\sigma_{n+1} - n - 1$ , and hence is topologically a closed cell. We will construct a homeomorphism

$$f: \bar{e}'(\sigma_1, \dots, \sigma_n) \times D \rightarrow \bar{e}'(\sigma_1, \dots, \sigma_{n+1}) .$$



In fact  $f$  is defined by the formula

$$f((x_1, \dots, x_n), u) = (x_1, \dots, x_n, Tu),$$

where the rotation  $T$  depends on  $x_1, \dots, x_n$ , as above. To prove that  $(x_1, \dots, x_n, Tu)$  actually belongs to  $\bar{e}'(\sigma_1, \dots, \sigma_{n+1})$  we note that

$$x_i \cdot Tu = Tb_i \cdot Tu = b_i \cdot u = 0$$

for  $i \leq n$ , and that

$$Tu \cdot Tu = u \cdot u = 1,$$

where  $Tu \in \bar{H}^{\sigma_{n+1}}$  since  $Tu \equiv u \pmod{R^{\sigma_n}}$ . Evidently  $f$  maps  $\bar{e}'(\sigma_1, \dots, \sigma_n) \times D$  continuously to  $\bar{e}'(\sigma_1, \dots, \sigma_{n+1})$ . Similarly the formula

$$u = T^{-1}x_{n+1} = T(x_1, b_1) \circ \dots \circ T(x_n, b_n)x_{n+1} \in D$$

shows that  $f^{-1}$  is well defined and continuous.

Thus  $\bar{e}'(\sigma_1, \dots, \sigma_{n+1})$  is homeomorphic to the product  $\bar{e}'(\sigma_1, \dots, \sigma_n) \times D$ . It follows by induction on  $n$  that each  $\bar{e}'(\sigma)$  is a closed cell of dimension  $d(\sigma)$ . A similar induction shows that each  $e'(\sigma)$  is the interior of the cell  $\bar{e}'(\sigma)$ . In fact the homeomorphism

$$f: \bar{e}'(\sigma_1, \dots, \sigma_n) \times D \rightarrow \bar{e}'(\sigma_1, \dots, \sigma_{n+1})$$

carries the product  $e'(\sigma_1, \dots, \sigma_n) \times \text{Interior } D$  onto  $e'(\sigma_1, \dots, \sigma_{n+1})$ .

*Proof that the map*

$$q|_{e'(\sigma)}: e'(\sigma) \rightarrow e(\sigma)$$

is a homeomorphism. According to Lemma 6.2,  $q$  carries  $e'(\sigma)$  in one-to-one fashion onto  $e(\sigma)$ . On the other hand, if  $(x_1, \dots, x_n)$  belongs to the "boundary"  $\bar{e}'(\sigma) - e'(\sigma)$ , then the  $n$ -plane  $X = q(x_1, \dots, x_n)$  does not belong to  $e(\sigma)$ , for one of the vectors  $x_i$  must lie in the boundary  $R^{\sigma_i-1}$  of the half-space  $\bar{H}^{\sigma_i}$ . This implies that

$$\dim (X \cap \mathbb{R}^{\sigma_i-1}) \geq i ,$$

and hence that  $X \notin e(\sigma)$ .

Now let  $A \subset e'(\sigma)$  be a relatively closed subset. Then  $\bar{A} \cap e'(\sigma) = A$ , where the closure  $\bar{A} \subset \bar{e}'(\sigma)$  is compact, hence  $q(\bar{A})$  is closed. The preceding paragraph implies that  $q(\bar{A}) \cap e(\sigma) = q(A)$ , and it follows that  $q(A) \subset e(\sigma)$  is a relatively closed set. Thus  $q$  maps the cell  $e'(\sigma)$  homeomorphically onto  $e(\sigma)$ . ■

**THEOREM 6.4.** *The  $(\binom{m}{n})$  sets  $e(\sigma)$  form the cells of a CW-complex with underlying space  $G_n(\mathbb{R}^m)$ . Similarly taking the direct limit as  $m \rightarrow \infty$ , one obtains an infinite CW-complex with underlying space  $G_n = G_n(\mathbb{R}^\infty)$ .*

*Proof.* We must first show that each point in the boundary of a cell  $e(\sigma)$  belongs to a cell  $e(\tau)$  of lower dimension. Since  $\bar{e}'(\sigma)$  is compact, the image  $q\bar{e}'(\sigma)$  is equal to  $\bar{e}(\sigma)$ . Hence every  $n$ -plane  $X$  in the boundary  $\bar{e}(\sigma) - e(\sigma)$  has a basis  $(x_1, \dots, x_n)$  belonging to  $\bar{e}'(\sigma) - e'(\sigma)$ . Evidently the vectors  $x_1, \dots, x_n$  are orthonormal, with  $x_i \in \mathbb{R}^{\sigma_i}$ . It follows that  $\dim (X \cap \mathbb{R}^{\sigma_i}) \geq i$  for each  $i$ , thus the Schubert symbol  $(\tau_1, \dots, \tau_n)$  associated with  $X$  must satisfy

$$\tau_1 \leq \sigma_1, \dots, \tau_n \leq \sigma_n .$$

As above, one of the vectors  $x_i$  must actually belong to  $\mathbb{R}^{\sigma_i-1}$ ; hence the corresponding integer  $\tau_i$  must be strictly less than  $\sigma_i$ . Therefore  $d(\tau) < d(\sigma)$ . Together with Lemma 6.3, this completes the proof that  $G_n(\mathbb{R}^m)$  is a finite CW-complex.

Similarly  $G_n(\mathbb{R}^\infty)$  is a CW-complex. The closure finiteness condition is satisfied since each  $X \in G_n(\mathbb{R}^\infty)$  belongs to a finite subcomplex  $G_n(\mathbb{R}^m)$ . The space  $G_n(\mathbb{R}^\infty)$  has the direct limit topology by definition. ■

It is instructive to look at the special case  $n = 1$ .

**COROLLARY 6.5.** *The infinite projective space  $P^\infty = G_1(\mathbb{R}^\infty)$  is a CW-complex having one  $r$ -cell  $e(r+1)$  for each integer  $r \geq 0$ . The closure  $\bar{e}(r+1) \subset P^\infty$  is equal to the finite projective space  $P^r$ .*

The proof is straightforward.

Now let us count the number of  $r$ -cells in  $G_n(\mathbb{R}^m)$  for arbitrary  $n$ . It is convenient to introduce the language of partitions.

**DEFINITION 6.6.** A *partition* of an integer  $r \geq 0$  is an unordered sequence  $i_1 i_2 \dots i_s$  of positive integers with sum  $r$ . The number of partitions of  $r$  is customarily denoted by  $p(r)$ . Thus for  $r \leq 10$  one has the following table.

$r$	0	1	2	3	4	5	6	7	8	9	10
$p(r)$	1	1	2	3	5	7	11	15	22	30	42

For example the integer 4 has five partitions, namely: 1 1 1 1, 1 1 2, 2 2, 1 3, and 4. The integer 0 has just one (vacuous) partition. (According to Hardy and Ramanujan the function  $p(r)$  is asymptotic to  $\exp(\pi\sqrt{2r/3})/4r\sqrt{3}$  as  $r \rightarrow \infty$ . For further information see [Ostmann].)

To every Schubert symbol  $(\sigma_1, \dots, \sigma_n)$  with  $d(\sigma) = r$  and  $\sigma_n \leq m$  there corresponds a partition  $i_1 \dots i_s$  of  $r$ , where  $i_1, \dots, i_s$  denotes the sequence obtained from  $\sigma_1 - 1, \dots, \sigma_n - n$  by cancelling any zeros which may appear at the beginning of this sequence. Clearly

$$1 \leq i_1 \leq i_2 \leq \dots \leq i_s \leq m - n$$

and  $s \leq n$ . Thus

**COROLLARY 6.7.** *The number of  $r$ -cells in  $G_n(\mathbb{R}^m)$  is equal to the number of partitions of  $r$  into at most  $n$  integers each of which is  $\leq m - n$ .*

In particular, if both  $n$  and  $m - n$  are  $\geq r$ , then the number of  $r$ -cells in  $G_n(\mathbb{R}^m)$  is equal to  $p(r)$ .

Note that this corollary remains true if  $m$  is allowed to take the value  $+\infty$ .

Here are five problems for the reader.

*Problem 6-A.* Show that a CW-complex is finite if and only if its underlying space is compact.

*Problem 6-B.* Show that the restriction homomorphism

$$i^* : H^p(G_n(\mathbb{R}^\infty)) \rightarrow H^p(G_n(\mathbb{R}^{n+k}))$$

is an isomorphism for  $p < k$ . Any coefficient group may be used. (Compare the description of cohomology for CW-complexes in Appendix A.)

*Problem 6-C.* Show that the correspondence  $X \xrightarrow{f} \mathbb{R}^1 \oplus X$  defines an embedding of the Grassmann manifold  $G_n(\mathbb{R}^m)$  into  $G_{n+1}(\mathbb{R}^1 \oplus \mathbb{R}^m) = G_{n+1}(\mathbb{R}^{m+1})$ , and that  $f$  is covered by a bundle map

$$\varepsilon^1 \oplus \gamma^n(\mathbb{R}^m) \rightarrow \gamma^{n+1}(\mathbb{R}^{m+1}).$$

Show that  $f$  carries the  $r$ -cell of  $G_n(\mathbb{R}^m)$  which corresponds to a given partition  $i_1 \dots i_s$  of  $r$  onto the  $r$ -cell of  $G_{n+1}(\mathbb{R}^{m+1})$  which corresponds to the same partition  $i_1 \dots i_s$ .

*Problem 6-D.* Show that the number of distinct Stiefel-Whitney numbers  $w_1^{r_1} \dots w_n^{r_n}[M]$  for an  $n$ -dimensional manifold is equal to  $p(n)$ .

*Problem 6-E.* Show that the number of  $r$ -cells in  $G_n(\mathbb{R}^{n+k})$  is equal to the number of  $r$ -cells in  $G_k(\mathbb{R}^{n+k})$  [or show that these two CW-complexes are actually isomorphic].

## §7. The Cohomology Ring $H^*(G_n; \mathbb{Z}/2)$

Still assuming the existence of Stiefel-Whitney classes, this section will compute the mod 2 cohomology of the infinite Grassmann manifold  $G_n = G_n(\mathbb{R}^\infty)$ , and will also prove a uniqueness theorem for Stiefel-Whitney classes. Recall that the canonical  $n$ -plane bundle over  $G_n$  is denoted by  $\gamma^n$ .

**THEOREM 7.1.** *The cohomology ring  $H^*(G_n; \mathbb{Z}/2)$  is a polynomial algebra over  $\mathbb{Z}/2$  freely generated by the Stiefel-Whitney classes  $w_1(\gamma^n), \dots, w_n(\gamma^n)$ .*

To prove this result, we first show the following.

**LEMMA 7.2.** *There are no polynomial relations among the  $w_i(\gamma^n)$ .*

*Proof.* Suppose that there is a relation of the form  $p(w_1(\gamma^n), \dots, w_n(\gamma^n)) = 0$ , where  $p$  is a polynomial in  $n$  variables with mod 2 coefficients. By Theorem 5.6, for any  $n$ -plane bundle  $\xi$  over a paracompact base space there exists a bundle map  $g : \xi \rightarrow \gamma^n$ . Hence

$$w_i(\xi) = \bar{g}^*(w_i(\gamma^n))$$

where  $\bar{g}$  is the map of base spaces induced by  $g$ . It follows that the cohomology classes  $w_i(\xi)$  must satisfy the corresponding relation

$$p(w_1(\xi), \dots, w_n(\xi)) = \bar{g}^* p(w_1(\gamma^n), \dots, w_n(\gamma^n)) = 0 .$$

Thus to prove 7.2 it will suffice to find some  $n$ -plane bundle  $\xi$  so that there are no polynomial relations among the classes  $w_1(\xi), \dots, w_n(\xi)$ .

Consider the canonical line bundle  $\gamma^1$  over the infinite projective space  $P^\infty$ . Recall from §4.3 that  $H^*(P^\infty; \mathbb{Z}/2)$  is a polynomial algebra over  $\mathbb{Z}/2$  with a single generator  $a$  of dimension 1, and recall that  $w(\gamma^1) = 1 + a$ . Forming the  $n$ -fold cartesian product  $X = P^\infty \times \dots \times P^\infty$ , it follows that  $H^*(X; \mathbb{Z}/2)$  is a polynomial algebra on  $n$  generators  $a_1, \dots, a_n$  of dimension 1. (Compare Appendix A, Theorem A.6; or [Spanier, p. 247].) Here  $a_i$  can be defined as the image  $\pi_i^*(a)$  induced by the projection map  $\pi_i : X \rightarrow P^\infty$  to the  $i$ -th factor. Let  $\xi$  be the  $n$ -fold cartesian product

$$\xi = \gamma^1 \times \dots \times \gamma^1 \cong (\pi_1^* \gamma^1) \oplus \dots \oplus (\pi_n^* \gamma^1) .$$

Then  $\xi$  is an  $n$ -plane bundle over  $X = P^\infty \times \dots \times P^\infty$ , and the total Stiefel-Whitney class

$$w(\xi) = w(\gamma^1) \times \dots \times w(\gamma^1) = \pi_1^*(w(\gamma^1)) \dots \pi_n^*(w(\gamma^1))$$

is equal to the  $n$ -fold product

$$(1+a) \times \dots \times (1+a) = (1+a_1)(1+a_2) \dots (1+a_n) .$$

In other words

$$w_1(\xi) = a_1 + a_2 + \dots + a_n,$$

$$w_2(\xi) = a_1 a_2 + a_1 a_3 + \dots + a_1 a_n + \dots + a_{n-1} a_n,$$

$$w_n(\xi) = a_1 a_2 \dots a_n,$$

and in general  $w_k(\xi)$  is the  $k$ -th *elementary symmetric function* of  $a_1, \dots, a_n$ . It is proved in textbooks on algebra, that the  $n$  elementary symmetric functions in  $n$  indeterminates over a field do not satisfy any polynomial relations. (See for example [Lang, pp. 132-134] or [van der Waerden, pp. 79, 176].) Thus the classes  $w_1(\xi), \dots, w_n(\xi)$  are algebraically independent over  $\mathbb{Z}/2$ , and it follows as indicated above that  $w_1(\gamma^n), \dots, w_n(\gamma^n)$  are also algebraically independent. ■

*Proof of 7.1.* We have shown that  $H^*(G_n)$ , with mod 2 coefficients, contains a polynomial algebra over  $\mathbb{Z}/2$  freely generated by  $w_1(y^n), \dots, w_n(y^n)$ . Using a counting argument, we will show that this sub-algebra actually coincides with  $H^*(G_n)$ .

Recall from §6.7 that the number of  $r$ -cells in the CW-complex  $G_n$  is equal to the number of partitions of  $r$  into at most  $n$  integers. Hence the rank of  $H^r(G_n)$  over  $\mathbb{Z}/2$  is at most equal to this number of partitions. (In fact, if  $C^r$  denotes the group of mod 2  $r$ -cochains for this CW-complex, and if  $Z^r \supset B^r$  denote the corresponding cocycle and coboundary groups, then the number of  $r$ -cells equals

$$\text{rank}(C^r) \geq \text{rank}(Z^r) \geq \text{rank}(Z^r/B^r) = \text{rank}(H^r.)$$

On the other hand the number of distinct monomials of the form  $w_1(y^n)^{r_1} \dots w_n(y^n)^{r_n}$  in  $H^r(G_n)$  is also precisely equal to the number of partitions of  $r$  into at most  $n$  integers. For to each sequence  $r_1, \dots, r_n$  of non-negative integers with

$$r_1 + 2r_2 + \dots + nr_n = r$$

we can associate the partition of  $r$  which is obtained from the  $n$ -tuple

$$r_n, r_n + r_{n-1}, \dots, r_n + r_{n-1} + \dots + r_1$$

by deleting any zeros which may occur; and conversely.

Since these monomials are known to be linearly independent mod 2, it follows that the inequalities above must all actually be equalities: The module  $H^r(G_n)$  over  $\mathbb{Z}/2$  has rank equal to the number of partitions of  $r$  into at most  $n$  integers, and has a basis consisting of the various monomials  $w_1(y^n)^{r_1} \dots w_n(y^n)^{r_n}$  of total dimension  $r$ . ■

It follows incidentally that the natural homomorphism  $\bar{g}^* : H^*(G_n) \rightarrow H^*(P^\infty \times \dots \times P^\infty)$  maps  $H^*(G_n)$  isomorphically onto the algebra consisting of all polynomials in the indeterminates  $a_1, \dots, a_n$  which are invariant under all permutations of these  $n$  indeterminates.

### Uniqueness of Stiefel-Whitney Classes

At this point we have not yet shown that there exist Stiefel-Whitney classes  $w_i(\xi)$  satisfying the four axioms of §4. Before proving existence, we will prove the following.

**UNIQUENESS THEOREM 7.3.** *There exists at most one correspondence  $\xi \mapsto w(\xi)$  which assigns to each vector bundle over a paracompact base space a sequence of cohomology classes satisfying the four axioms for Stiefel-Whitney classes.*

*Proof.* Suppose that there were two such, say  $\xi \mapsto w(\xi)$  and  $\xi \mapsto \tilde{w}(\xi)$ . For the canonical line bundle  $\gamma_1^1$  over  $P^1$  we have

$$w(\gamma_1^1) = \tilde{w}(\gamma_1^1) = 1 + a$$

by Axioms 1 and 4. Embedding  $\gamma_1^1$  in the line bundle  $\gamma^1$  over the infinite projective space  $P^\infty$ , it follows that

$$w(\gamma^1) = \tilde{w}(\gamma^1) = 1 + a$$

by Axioms 1 and 2. Passing to the  $n$ -fold cartesian product

$$\xi = \gamma^1 \times \dots \times \gamma^1 \cong \pi_1^* \gamma^1 \oplus \dots \oplus \pi_n^* \gamma^1 ,$$

it follows that

$$w(\xi) = \tilde{w}(\xi) = (1+a_1) \dots (1+a_n)$$

by Axioms 2 and 3. Now using the existence of a bundle map  $\xi \rightarrow \gamma^n$ , and the fact that  $H^*(G_n)$  injects monomorphically into  $H^*(P^\infty \times \dots \times P^\infty)$ , it follows that  $w(\gamma^n) = \tilde{w}(\gamma^n)$ .

For any  $n$ -plane bundle  $\eta$  over a paracompact base space, choosing a bundle map  $f : \eta \rightarrow \gamma^n$ , it follows immediately that

$$w(\eta) = \bar{f}^* w(\gamma^n) = \bar{f}^* \tilde{w}(\gamma^n) = \tilde{w}(\eta) . \blacksquare$$



REMARK. Using essentially this same argument, it would not be difficult to prove a corresponding uniqueness theorem for Stiefel-Whitney classes, working in the much smaller category consisting of smooth vector bundles and smooth bundle mappings, all of the base spaces being smooth paracompact manifolds. It would be much more difficult, however, to prove such a result using only tangent bundles of manifolds. Compare [Blanton and Schweitzer].

Here are three problems for the reader. The first two are based on Problem 6-C.

*Problem 7-A.* Identify explicitly the cocycle in  $C^r(G_n) \cong H^r(G_n)$  which corresponds to the Stiefel-Whitney class  $w_r(\gamma^n)$ .

*Problem 7-B.* Show that the cohomology algebra  $H^*(G_n(\mathbb{R}^{n+k}))$  over  $\mathbb{Z}/2$  is generated by the Stiefel-Whitney classes  $w_1, \dots, w_n$  of  $\gamma^n$  and the dual classes  $\bar{w}_1, \dots, \bar{w}_k$ , subject only to the  $n+k$  defining relations

$$(1 + w_1 + \dots + w_n)(1 + \bar{w}_1 + \dots + \bar{w}_k) = 1 \quad .$$

(Reference: [Borel, 1953, p. 190].)

*Problem 7-C.* Let  $\xi^m$  and  $\eta^n$  be vector bundles over a paracompact base space. Show that the Stiefel-Whitney classes of the tensor product  $\xi^m \otimes \eta^n$  (or of the isomorphic bundle  $\text{Hom}(\xi^m, \eta^n)$ ) can be computed as follows. If the fiber dimensions  $m$  and  $n$  are both 1, then

$$w_1(\xi^1 \otimes \eta^1) = w_1(\xi^1) + w_1(\eta^1) \quad .$$

More generally there is a universal formula of the form

$$w(\xi^m \otimes \eta^n) = p_{m,n}(w_1(\xi^m), \dots, w_m(\xi^m), w_1(\eta^n), \dots, w_n(\eta^n))$$

where the polynomial  $p_{m,n}$  in  $m+n$  variables can be characterized as follows. If  $\sigma_1, \dots, \sigma_m$  are the elementary symmetric functions of indeterminates  $t_1, \dots, t_m$ , and if  $\sigma'_1, \dots, \sigma'_n$  are the elementary symmetric functions of  $t'_1, \dots, t'_n$ , then

$$P_{m,n}(\sigma_1, \dots, \sigma_m, \sigma'_1, \dots, \sigma'_n) = \prod_{i=1}^m \prod_{j=1}^n (1 + t_i + t'_j) .$$

[Hint: The cohomology of  $G_m \times G_n$  can be computed by the Künneth Theorem (Appendix A.6). The formula for  $w(\xi^m \otimes \eta^n)$  can be verified first in the special case when  $\xi^m$  and  $\eta^n$  are Whitney sums of line bundles.]

## §8. Existence of Stiefel-Whitney Classes

We now proceed to prove the existence of Stiefel-Whitney classes by giving a construction in terms of known operations. For any  $n$ -plane bundle  $\xi$  with total space  $E$ , base space  $B$  and projection map  $\pi$ , we denote by  $E_0$  the set of all non-zero elements of  $E$ , and by  $F_0$  the set of all non-zero elements of a typical fiber  $F = \pi^{-1}(b)$ . Clearly  $F_0 = F \cap E_0$ .

Using singular theory and one of several techniques (e.g. spectral sequences or that of §10) we have that

$$H^i(F, F_0; \mathbb{Z}/2) = \begin{cases} 0 & \text{for } i \neq n \\ \mathbb{Z}/2 & \text{for } i = n \end{cases}$$

and that

$$H^i(E, E_0; \mathbb{Z}/2) \cong \begin{cases} 0 & \text{for } i < n \\ H^{i-n}(B; \mathbb{Z}/2) & \text{for } i \geq n \end{cases}.$$

(This can be seen intuitively, though not rigorously, as follows: The unit  $n$ -cell is a deformation retract of  $\mathbb{R}^n$  and the unit  $(n-1)$ -sphere is a deformation retract of  $(\mathbb{R}^n - \text{origin}) = \mathbb{R}_0^n$ . For  $B$  paracompact, we know that we can put a Euclidean metric on  $E$ . Then the subset  $E'$  consisting of all vectors  $x \in E$  with  $x \cdot x \leq 1$  is evidently a deformation retract of  $E$ . Similarly the set  $E''$  consisting of vectors  $x \in E$  with  $x \cdot x = 1$  is a deformation retract of  $E_0$ . Hence  $H^*(E', E'') \cong H^*(E, E_0)$ . Now suppose that  $B$  is a cell complex, with a fine enough cell subdivision so that the restriction of  $\xi$  to each cell  $c^k$  is a trivial bundle. Then the inverse image of the  $k$ -cell  $c^k$  in  $E'$  is a product cell of dimension  $n+k$ . Thus  $E'$  can be obtained from the subset  $E''$  by adjoining cells of dimension  $\geq n$ , one  $(n+k)$ -cell corresponding to each  $k$ -cell of  $B$ . It follows that

$H^i(E', E'') = 0$  for  $i < n$ . With a little faith, it follows also that  $H^{n+k}(E', E'') \cong H^k(B)$ .

Rigorously and more explicitly, the following statement will be proved in §10. The coefficient group  $\mathbb{Z}/2$  is to be understood.

**THEOREM 8.1.** *The group  $H^i(E, E_0)$  is zero for  $i < n$ , and  $H^n(E, E_0)$  contains a unique class  $u$  such that for each fiber  $F = \pi^{-1}(b)$  the restriction*

$$u|_{(F, F_0)} \in H^n(F, F_0)$$

*is the unique non-zero class in  $H^n(F, F_0)$ . Furthermore the correspondence  $x \mapsto x \cup u$  defines an isomorphism  $H^k(E) \rightarrow H^{k+n}(E, E_0)$  for every  $k$ . (We call  $u$  the fundamental cohomology class.)*

On the other hand the projection  $\pi: E \rightarrow B$  certainly induces an isomorphism  $H^k(B) \rightarrow H^k(E)$ , since the zero cross-section embeds  $B$  as a deformation retract of  $E$  with retraction mapping  $\pi$ .

**DEFINITION 8.2.** The *Thom isomorphism*  $\phi: H^k(B) \rightarrow H^{k+n}(E, E_0)$  is defined to be the composition of the two isomorphisms

$$H^k(B) \xrightarrow{\pi^*} H^k(E) \xrightarrow{\cup u} H^{k+n}(E, E_0).$$

Next we will make use of the Steenrod squaring operations in  $H^*(E, E_0)$ . These operations can be characterized by four basic properties, as follows. (Compare [Steenrod and Epstein].) Again mod 2 coefficients are to be understood.

(1) For each pair  $X \supset Y$  of spaces and each pair  $n, i$  of non-negative integers there is defined an additive homomorphism

$$Sq^i: H^n(X, Y) \rightarrow H^{n+i}(X, Y).$$

(This homomorphism is called "square upper  $i$ .")

(2) *Naturality.* If  $f: (X, Y) \rightarrow (X', Y')$  then  $Sq^i \circ f^* = f^* \circ Sq^i$ .

(3) If  $a \in H^n(X, Y)$ , then  $Sq^0(a) = a$ ,  $Sq^n(a) = a \cup a$ , and  $Sq^i(a) = 0$  for  $i > n$ . (Thus the most interesting squaring operations are those for which  $0 < i < n$ .)

(4) *The Cartan formula.* The identity

$$Sq^k(a \cup b) = \sum_{i+j=k} Sq^i(a) \cup Sq^j(b)$$

is valid whenever  $a \cup b$  is defined.

Using these squaring operations together with the Thom isomorphism  $\phi$ , the *Stiefel-Whitney class*  $w_i(\xi) \in H^i(B)$  can now be defined by Thom's identity

$$w_i(\xi) = \phi^{-1} Sq^i \phi(1) .$$

In other words  $w_i(\xi)$  is the unique cohomology class in  $H^i(B)$  such that  $\phi(w_i(\xi)) = \pi^* w_i(\xi) \cup u$  is equal to  $Sq^i \phi(1) = Sq^i(u)$ .

For many purposes it is convenient to introduce the *total squaring operation*

$$Sq(a) = a + Sq^1(a) + Sq^2(a) + \dots + Sq^n(a)$$

for  $a \in H^n(S, Y)$ . Note that the Cartan formula can now be expressed by the equation

$$Sq(a \cup b) = (Sq a) \cup (Sq b) .$$

Similarly the corresponding equation for the Steenrod squares of a cross product becomes simply

$$Sq(a \times b) = (Sq a) \times (Sq b) .$$

In terms of this total squaring operation, the total Stiefel-Whitney class of a vector bundle is clearly determined by the formula

$$w(\xi) = \phi^{-1} Sq \phi(1) = \phi^{-1} Sq(u) .$$

### Verification of the Axioms

With this definition, the four axioms for Stiefel-Whitney classes can be checked as follows.

**AXIOM 1.** Using properties (1) and (3) of the squaring operations, it is clear that  $w_i(\xi) \in H^i(B)$ , with  $w_0(\xi) = 1$ , and with  $w_i(\xi) = 0$  for  $i$  greater than the fiber dimension  $n$ .

**AXIOM 2.** Any bundle map  $f: \xi \rightarrow \xi'$  clearly induces a map  $g: (E, E_0) \rightarrow (E', E'_0)$ . Furthermore if  $u'$  denotes the fundamental cohomology class in  $H^n(E', E'_0)$ , then  $g^*(u')$  is equal to the class  $u \in H^n(E, E_0)$  by the definition of  $u$  (§8.1). It now follows easily that the Thom isomorphisms  $\phi$  and  $\phi'$  satisfy the naturality condition

$$g^* \circ \phi' = \phi \circ \bar{f}^* .$$

Hence, using property (2), it follows that

$$\bar{f}^* w_i(\xi') = w_i(\xi) ,$$

as required.

**AXIOM 3.** Let us first compute the Stiefel-Whitney classes of a cartesian product  $\xi'' = \xi \times \xi'$ , with projection map  $\pi \times \pi': E \times E' \rightarrow B \times B'$ . Consider the fundamental classes

$$u \in H^m(E, E_0), \quad u' \in H^n(E', E'_0)$$

of  $\xi$  and  $\xi'$ . Since  $E_0$  is open in  $E$  and  $E'_0$  is open in  $E'$ , the cross product

$$u \times u' \in H^{m+n}(E \times E', E \times E'_0 \cup E_0 \times E')$$

is defined. (Compare Appendix A.) Note that the open subset  $(E \times E'_0) \cup (E_0 \times E')$  in the total space  $E'' = E \times E'$  is precisely equal to the set  $E''_0$  of non-zero vectors in  $E''$ . In fact we claim that  $u \times u'$  is precisely equal to the fundamental class  $u'' \in H^{m+n}(E'', E''_0)$ . In order to prove this, it suffices to show that the restriction

$$u \times u' | (F'', F_0'')$$

is the non-zero cohomology class in  $H^{m+n}(F'', F_0'')$  for every fiber  $F'' = F \times F'$  of  $\xi''$ . But this restriction is evidently equal to the cross product of  $u | (F, F_0)$  and  $u' | (F', F_0')$ , and hence is non-zero by A.5 in the Appendix.

It follows easily that the Thom isomorphisms for  $\xi$ ,  $\xi'$ , and  $\xi''$  are related by the identity

$$\phi''(a \times b) = \phi(a) \times \phi'(b) .$$

In fact if  $\bar{a} = \pi^*(a) \in H^*(E)$  and  $\bar{b} = \pi'^*(b) \in H^*(E')$ , then this follows from the equation

$$(\bar{a} \times \bar{b}) \cup (u \times u') = (\bar{a} \cup u) \times (\bar{b} \cup u') ,$$

where there is no sign since we are working modulo 2.

The total Stiefel-Whitney class of  $\xi''$  can now be computed by the formula

$$\phi''(w(\xi'')) = Sq(u'') = Sq(u \times u') = Sq(u) \times Sq(u') .$$

Setting the right side equal to

$$\phi(w(\xi)) \times \phi'(w(\xi')) = \phi''(w(\xi) \times w(\xi')) ,$$

and then applying  $(\phi'')^{-1}$  to both sides, we have proved that

$$w(\xi \times \xi') = w(\xi) \times w(\xi') .$$

Now suppose that  $\xi$  and  $\xi'$  are bundles over a common base space  $B$ . Lifting both sides of this equation back to  $B$  by means of the diagonal embedding  $B \rightarrow B \times B$ , we obtain the required formula

$$w(\xi \oplus \xi') = w(\xi) \cup w(\xi') .$$

AXIOM 4. Let  $\gamma_1^1$  be as usual the twisted line bundle over the circle  $P^1$ . Then the space of vectors of length  $\leq 1$  in the total space  $E = E(\gamma_1^1)$

is evidently a Moebius band  $M$ , bounded by a circle  $\dot{M}$ . Since  $M$  is a deformation retract of  $E$ , and  $\dot{M}$  a deformation retract of  $E_0$ , we have

$$H^*(M, \dot{M}) \cong H^*(E, E_0) .$$

On the other hand if we embed a 2-cell  $D^2$  in the projective plane  $P^2$ , then the closure of  $P^2 - D^2$  is homeomorphic to  $M$ . Using the Excision Theorem of cohomology theory, it follows that

$$H^*(M, \dot{M}) \cong H^*(P^2, D^2) .$$

Hence there are natural isomorphisms

$$H^i(E, E_0) \rightarrow H^i(M, \dot{M}) \leftarrow H^i(P^2, D^2) \rightarrow H^i(P^2)$$

for every dimension  $i \neq 0$ . The fundamental cohomology class  $u \in H^1(E, E_0)$  certainly cannot be zero. Hence it must correspond to the generator  $a \in H^1(P^2)$  under the composite isomorphism. Hence  $Sq^1(u) = u \cup u$  must correspond to  $Sq^1(a) = a \cup a$ . But  $a \cup a \neq 0$  by 4.3, so it follows that

$$w_1(\gamma_1^1) = \phi^{-1} Sq^1(u)$$

must also be non-zero. This concludes the verification of the four axioms. ■

Here are two problems for the reader.

*Problem 8-A.* It follows from 7.1 that the cohomology class  $Sq^k w_m(\xi)$  can be expressed as a polynomial in  $w_1(\xi), \dots, w_{m+k}(\xi)$ . Prove Wu's explicit formula

$$Sq^k(w_m) = w_k w_m + \binom{k-m}{1} w_{k-1} w_{m+1} + \dots + \binom{k-m}{k} w_0 w_{m+k} ,$$

where  $\binom{x}{i} = x(x-1)\dots(x-i+1)/i!$ , as follows. If the formula is true for  $\xi$ , show that it is true for  $\xi \times \gamma^1$ . Thus by induction it is true for  $\gamma^1 \times \dots \times \gamma^1$ , and hence for all  $\xi$ .

*Problem 8-B.* If  $w(\xi) \neq 1$ , show that the smallest  $n > 0$  with  $w_n(\xi) \neq 0$  is a power of 2. (Use the fact that  $\binom{x}{k}$  is odd whenever  $x$  is an odd multiple of  $k = 2^r$ .)



## §9. Oriented Bundles and the Euler Class

Up to this point we have always used the coefficient group  $\mathbb{Z}/2$  for our cohomology. This of necessity means that we have overlooked much interesting structure. Now we will take a closer look, using the integers  $\mathbb{Z}$  as coefficient group. But in order to do this it will be necessary to impose the additional structure of an orientation on our vector bundles. In particular we will need an orientation in order to construct the fundamental cohomology class  $u \in H^n(E, E_0)$  with integer coefficients.

First consider the case of a single vector space.

**DEFINITION.** An *orientation* of a real vector space  $V$  of dimension  $n > 0$  is an equivalence class of bases, where two (ordered) bases  $v_1, \dots, v_n$  and  $v'_1, \dots, v'_n$  are said to be equivalent if and only if the matrix  $[a_{ij}]$  defined by the equation  $v'_i = \sum a_{ij} v_j$  has positive determinant. Evidently every such vector space  $V$  has precisely two distinct orientations. Note that the coordinate space  $\mathbb{R}^n$  has a canonical orientation, corresponding to its canonical ordered basis.

In algebraic topology, it is customary to specify the orientation of a simplex by choosing some ordering of its vertices. Our concept of orientation is related as follows. Let  $\Sigma^n$  be an  $n$ -simplex, linearly embedded in the  $n$ -dimensional vector space  $V$ , with ordered vertices  $A_0, A_1, \dots, A_n$ . Then taking the vector from  $A_0$  to  $A_1$  as first basis vector, the vector from  $A_1$  to  $A_2$  as second, and so on, we obtain a corresponding orientation for the vector space  $V$ .

Note that a choice of orientation for  $V$  corresponds to a choice of one of the two possible generators for the singular homology group  $H_n(V, V_0; \mathbb{Z})$ . In fact let  $\Delta^n$  denote the standard  $n$ -simplex, with canonically ordered vertices. Choose some orientation preserving linear embedding

$$\sigma : \Delta^n \rightarrow V$$

which maps the barycenter of  $\Delta^n$  to the zero vector (and hence maps the boundary of  $\Delta^n$  into  $V_0$ ). Then  $\sigma$  is a singular  $n$ -simplex representing an element in the group of relative  $n$ -cycles  $Z_n(V, V_0; \mathbb{Z})$ . The homology class of this  $n$ -cycle  $\sigma$  is now the preferred generator  $\mu_V$  for the homology group  $H_n(V, V_0; \mathbb{Z})$ .

Similarly the cohomology group  $H^n(V, V_0; \mathbb{Z})$  associated with an oriented vector space  $V$  has a preferred generator which we denote by the symbol  $u_V$ , determined by the equation  $\langle u_V, \mu_V \rangle = +1$ .

Now consider a vector bundle  $\xi$  of fiber dimension  $n > 0$ .

**DEFINITION.** An *orientation* for  $\xi$  is a function which assigns an orientation to each fiber  $F$  of  $\xi$ , subject to the following local compatibility condition. For every point  $b_0$  in the base space there should exist a local coordinate system  $(N, h)$ , with  $b_0 \in N$  and  $h : N \times \mathbb{R}^n \rightarrow \pi^{-1}(N)$ , so that for each fiber  $F = \pi^{-1}(b)$  over  $N$  the homomorphism  $x \mapsto h(b, x)$  from  $\mathbb{R}^n$  to  $F$  is orientation preserving. (Or equivalently there should exist sections  $s_1, \dots, s_n : N \rightarrow \pi^{-1}(N)$  so that the basis  $s_1(b), \dots, s_n(b)$  determines the required orientation of  $\pi^{-1}(b)$  for each  $b$  in  $N$ .)

In terms of cohomology, this means that to each fiber  $F$  there is assigned a preferred generator

$$u_F \in H^n(F, F_0; \mathbb{Z}) .$$

The local compatibility condition implies that for every point in the base space there exists a neighborhood  $N$  and a cohomology class

$$u \in H^n(\pi^{-1}(N), \pi^{-1}(N)_0; \mathbb{Z})$$

so that for every fiber  $F$  over  $N$  the restriction

$$u|_{(F, F_0)} \in H^n(F, F_0; \mathbb{Z})$$

is equal to  $u_F$ . The proof is straightforward.

The following important result will be proved in § 10. (Compare Theorem 8.1.)

**THEOREM 9.1.** *Let  $\xi$  be an oriented  $n$ -plane bundle with total space  $E$ . Then the cohomology group  $H^i(E, E_0; \mathbb{Z})$  is zero for  $i < n$ , and  $H^n(E, E_0; \mathbb{Z})$  contains one and only one cohomology class  $u$  whose restriction*

$$u|_{(F, F_0)} \in H^n(F, F_0; \mathbb{Z})$$

*is equal to the preferred generator  $u_F$  for every fiber  $F$  of  $\xi$ . Furthermore the correspondence  $y \mapsto y \cup u$  maps  $H^k(E; \mathbb{Z})$  isomorphically onto  $H^{k+n}(E, E_0; \mathbb{Z})$  for every integer  $k$ .*

In more technical language, this theorem can be summarized by saying that  $H^*(E, E_0; \mathbb{Z})$  is a free  $H^*(E; \mathbb{Z})$ -module on one generator  $u$  of degree  $n$ . (More generally, any ring with unit could be used as coefficient group.)

It follows of course that  $H^{k+n}(E, E_0; \mathbb{Z})$  is isomorphic to the cohomology group  $H^k(B; \mathbb{Z})$  of the base space. In fact the *Thom isomorphism*

$$\phi : H^k(B; \mathbb{Z}) \rightarrow H^{k+n}(E, E_0; \mathbb{Z})$$

can be defined by the formula

$$\phi(x) = (\pi^*x) \cup u ,$$

just as in §8.

We are now ready to define an important new characteristic class. Given an oriented  $n$ -plane bundle  $\xi$ , the inclusion  $(E, \text{empty set}) \subset (E, E_0)$  gives rise to a restriction homomorphism

$$H^*(E, E_0; \mathbb{Z}) \rightarrow H^*(E; \mathbb{Z})$$

which we denote by  $y \mapsto y|E$ . In particular, applying this homomorphism to the fundamental class  $u \in H^n(E, E_0; \mathbb{Z})$ , we obtain a new cohomology class

$$u|E \in H^n(E; \mathbb{Z}) .$$

But  $H^n(E; \mathbb{Z})$  is canonically isomorphic to the cohomology group  $H^n(B; \mathbb{Z})$  of the base space.

**DEFINITION.** The *Euler class* of an oriented  $n$ -plane bundle  $\xi$  is the cohomology class

$$e(\xi) \in H^n(B; \mathbb{Z})$$

which corresponds to  $u|E$  under the canonical isomorphism  $\pi^*: H^n(B; \mathbb{Z}) \rightarrow H^n(E; \mathbb{Z})$ .

For the motivation for the name ‘‘Euler class,’’ we refer the reader to p. 130. Here are some fundamental properties of the Euler class:

**PROPERTY 9.2. (Naturality).** *If  $f: B \rightarrow B'$  is covered by an orientation preserving bundle map  $\xi \rightarrow \xi'$ , then  $e(\xi) = f^*e(\xi')$ .*

In particular, if  $\xi$  is a trivial  $n$ -plane bundle,  $n > 0$ , then  $e(\xi) = 0$ . For in this case we can take  $\xi'$  to be a bundle over a point.

**PROPERTY 9.3.** *If the orientation of  $\xi$  is reversed, then the Euler class  $e(\xi)$  changes sign.*

The proofs are immediate. ■

**PROPERTY 9.4.** *If the fiber dimension  $n$  is odd, then  $e(\xi) + e(\xi) = 0$ .*

Because of this, we will usually assume that the fiber dimension is even when making use of Euler classes.

*First Proof.* Any odd dimensional vector bundle possesses an orientation reversing automorphism  $(b, v) \mapsto (b, -v)$ . The required equation  $e(\xi) = -e(\xi)$  now follows from 9.3.

*Alternative Proof.* The Thom isomorphism  $\phi(x) = (\pi^*(x) \cup u$  evidently maps  $e(\xi)$  to the cohomology class

$$\pi^* e(\xi) \cup u = (u | E) \cup u = u \cup u .$$

In other words

$$e(\xi) = \phi^{-1}(u \cup u) .$$

But using the identity

$$a \cup b = (-1)^{(\dim a)(\dim b)} b \cup a$$

we see that  $u \cup u$  is an element of order 2 whenever the dimension  $n$  is odd. ■

**PROPERTY 9.5.** *The natural homomorphism  $H^n(B; \mathbb{Z}) \rightarrow H^n(B; \mathbb{Z}/2)$  carries the Euler class  $e(\xi)$  to the top Stiefel-Whitney class  $w_n(\xi)$ .*

*Proof.* If we apply this homomorphism (induced by the coefficient surjection  $\mathbb{Z} \rightarrow \mathbb{Z}/2$ ) to both sides of the equation  $e(\xi) = \phi^{-1}(u \cup u)$ , then evidently the integer cohomology class  $u$  maps to the mod 2 cohomology class  $u$  of §8, and  $u \cup u$  maps to  $Sq^n(u)$ . Hence  $\phi^{-1}(u \cup u)$  maps to  $\phi^{-1}Sq^n(u) = w_n(\xi)$ . ■

Several important properties of the characteristic class  $w_n(\xi)$  apply equally well to  $e(\xi)$ .

PROPERTY 9.6. *The Euler class of a Whitney sum is given by  $e(\xi \oplus \xi') = e(\xi) \cup e(\xi')$ . Similarly the Euler class of a cartesian product is given by  $e(\xi \times \xi') = e(\xi) \times e(\xi')$ .*

Here we must specify that the direct sum  $F \oplus F'$  of two oriented vector spaces is to be oriented by taking an oriented basis for  $F$  followed by an oriented basis for  $F'$ .

*Proof of 9.6.* Let the fiber dimensions be  $m$  and  $n$  respectively. Taking account of our sign conventions as specified in Appendix A, it is not difficult to check that the fundamental cohomology class of the cartesian product is given by

$$u(\xi \times \xi') = (-1)^{mn} u(\xi) \times u(\xi') .$$

(Compare the verification of Axiom 3 in §8. If we used the classical system of sign conventions, as in [Spanier], then there would be no sign here.) Now apply the restriction homomorphism

$$H^{m+n}(E \times E', (E \times E')_0) \rightarrow H^{m+n}(E \times E') \approx H^{m+n}(B \times B')$$

to both sides. It follows easily that

$$e(\xi \times \xi') = (-1)^{mn} e(\xi) \times e(\xi') ;$$

where the sign can be ignored since the right side of this equation is an element of order two whenever  $m$  or  $n$  is odd.

Now suppose that  $B = B'$ . Pulling both sides of this equation back to  $H^{m+n}(B; \mathbb{Z})$  by means of the diagonal embedding  $B \rightarrow B \times B$ , we obtain the formula  $e(\xi \oplus \xi') = e(\xi) \cup e(\xi')$  for the Euler class of a Whitney sum. ■

REMARK. Although this formula looks very much like the corresponding formula  $w(\xi \oplus \xi') = w(\xi) \cup w(\xi')$  for Stiefel-Whitney classes, there is one essential difference. The total Stiefel-Whitney class  $w(\xi)$  is a unit in the ring  $H^{\Pi}(B; \mathbb{Z}/2)$ , hence it is easy to solve for  $w(\xi')$  as a

function of  $w(\xi)$  and  $w(\xi \oplus \xi')$ . (Compare §4.1.) However the Euler class  $e(\xi)$  is certainly not a unit in the integral cohomology ring of  $B$ , and in fact it may well be zero or a zero-divisor. So the equation  $e(\xi \oplus \xi') = e(\xi) \cup e(\xi')$  cannot usually be solved for  $e(\xi')$  as a function of  $e(\xi)$  and  $e(\xi \oplus \xi')$ .

Here is an application of 9.6. Let  $\eta$  be a vector bundle for which  $2e(\eta) \neq 0$ . Then it follows that  $\eta$  cannot split as the Whitney sum of two oriented odd dimensional vector bundles. As an example, let  $M$  be a smooth compact manifold. Suppose that the tangent bundle  $\tau$  of  $M$  is oriented, and that  $e(\tau) \neq 0$ . Then  $\tau$  cannot admit any odd dimensional sub vector bundle. For if this sub-bundle  $\xi$  were orientable, then the Euler class  $e(\tau) = e(\xi) \cup e(\xi^\perp)$  would have to be an element of order two in the free abelian group  $H^n(M; \mathbb{Z})$ . (Compare Appendix A.) The case where  $\xi$  is not orientable can be handled by passing to a suitable 2-fold covering manifold of  $M$ . Details will be left to the reader.

**PROPERTY 9.7.** *If the oriented vector bundle  $\xi$  possesses a nowhere zero cross-section, then the Euler class  $e(\xi)$  must be zero.*

*Proof.* Let  $s: B \rightarrow E_0$  be a cross-section, so that the composition

$$B \xrightarrow{s} E_0 \subset E \xrightarrow{\pi} B$$

is the identity map of  $B$ . Then the corresponding composition

$$H^n(B) \xrightarrow{\pi^*} H^n(E) \longrightarrow H^n(E_0) \xrightarrow{s^*} H^n(B)$$

is the identity map of  $H^n(B)$ . By definition the first homomorphism  $\pi^*$  maps  $e(\xi)$  to the restriction  $u|E$ . Hence the first two homomorphisms in this composition map  $e(\xi)$  to the restriction  $(u|E)|E_0$  which is zero since the composition

$$H^n(E, E_0) \rightarrow H^n(E) \rightarrow H^n(E_0)$$

is zero. Applying  $s^*$ , it follows that  $e(\xi) = s^*(0) = 0$ . ■

[If the bundle  $\xi$  possesses a Euclidean metric, then an alternative proof can be given as follows: Let  $\varepsilon$  be the trivial line bundle spanned by the cross-section  $s$  of  $\xi$ . Then

$$e(\xi) = e(\varepsilon) \cup e(\varepsilon^\perp)$$

by 9.6, where the class  $e(\varepsilon)$  is zero by 9.2.]

To conclude this section we will describe some examples of bundles with non-zero Euler class. (See also §11 and §15.)

*Problem 9-A.* Recall that  $\gamma^n$  denotes the canonical  $n$ -plane bundle over the infinite Grassmann manifold  $G_n(\mathbb{R}^\infty)$ . Show that  $\gamma^n \oplus \gamma^n$  is an orientable vector bundle with  $w_{2n}(\gamma^n \oplus \gamma^n) \neq 0$ , and hence  $e(\gamma^n \oplus \gamma^n) \neq 0$ . If  $n$  is odd, show that  $2e(\gamma^n \oplus \gamma^n) = 0$ .

*Problem 9-B.* Now consider the complex Grassmann manifold  $G_n(\mathbb{C}^\infty)$ , consisting of all complex sub vector spaces of complex dimension  $n$  in infinite complex coordinate space. (Compare §14.) Since every complex  $n$ -plane can be thought of as a real oriented  $2n$ -plane, it follows that there is a canonical oriented  $2n$ -plane bundle  $\xi^{2n}$  over  $G_n(\mathbb{C}^\infty)$ . Show that the restriction of  $\xi^{2n}$  to the real sub-space  $G_n(\mathbb{R}^\infty)$  is isomorphic to  $\gamma^n \oplus \gamma^n$ , and hence that  $e(\xi^{2n}) \neq 0$ . (Remark: The group  $H^{2n}(G_n(\mathbb{C}^\infty); \mathbb{Z})$  is actually free abelian, with  $e(\xi^{2n})$  as one of its generators. See §14.3.)

*Problem 9-C.* Let  $\tau$  be the tangent bundle of the  $n$ -sphere, and let  $A \subset S^n \times S^n$  be the anti-diagonal, consisting of all pairs of antipodal unit vectors. Using stereographic projection, show that the total space  $E = E(\tau)$  is canonically homeomorphic to  $S^n \times S^n - A$ . Hence, using excision and homotopy, show that



$$H^*(E, E_0) \approx H^*(S^n \times S^n, S^n \times S^n\text{-diagonal}) \approx H^*(S^n \times S^n, A) \subset H^*(S^n \times S^n).$$

(Compare §11.) Now suppose that  $n$  is even. Show that the Euler class  $e(\tau) = \phi^{-1}(u \cup u)$  is twice a generator of  $H^n(S^n; \mathbb{Z})$ . As a corollary, show that  $\tau$  possesses no non-trivial sub vector bundles.

## §10. The Thom Isomorphism Theorem

This section will first give a complete proof of the Thom isomorphism theorem in the unoriented case (compare §8.1), and then describe the changes needed for the oriented case (§9.1). For the first half of this section, the coefficient field  $\mathbb{Z}/2$  is to be understood.

We begin by outlining some constructions which are described in more detail in Appendix A. (See in particular A.5.) Let  $R_0^n$  denote the set of non-zero vectors in  $\mathbb{R}^n$ . For  $n = 1$  the cohomology group  $H^1(\mathbb{R}, R_0)$  with mod 2 coefficients is cyclic of order 2. Let  $e^1$  denote the non-zero element. Then for any topological space  $B$  a cohomology isomorphism

$$H^j(B) \rightarrow H^{j+1}(B \times \mathbb{R}, B \times R_0)$$

is defined by the correspondence

$$y \mapsto y \times e^1 ,$$

using the cohomology cross product operation. This is proved by studying the cohomology exact sequence of the triple  $(B \times \mathbb{R}, B \times R_0, B \times \mathbb{R}_-)$ , where  $\mathbb{R}_-$  denotes the set of negative real numbers.

Now let  $B'$  be an open subset of  $B$ . Then for each cohomology class  $y \in H^j(B, B')$  the cross product  $y \times e^1$  is defined with

$$y \times e^1 \in H^{j+1}(B \times \mathbb{R}, B' \times \mathbb{R} \cup B \times R_0) .$$

Using the Five Lemma\* it follows that the correspondence  $y \mapsto y \times e^1$  defines an isomorphism

---

\* See for example [Spanier, p. 185].

$$H^j(B, B') \rightarrow H^{j+1}(B \times \mathbb{R}, B' \times \mathbb{R} \cup B \times \mathbb{R}_0) .$$

Therefore it follows inductively that the  $n$ -fold composition

$$y \mapsto y \times e^1 \mapsto y \times e^1 \times e^1 \mapsto \dots \mapsto y \times e^1 \times \dots \times e^1$$

is also an isomorphism. (See Appendix A for further details.) Setting

$$e^n = e^1 \times \dots \times e^1 \in H^n(\mathbb{R}^n, \mathbb{R}_0^n) ,$$

this proves the following.

**LEMMA 10.1.** *For any topological space  $B$  and any  $n \geq 1$ , a cohomology isomorphism*

$$H^j(B) \rightarrow H^{j+n}(B \times \mathbb{R}^n, B \times \mathbb{R}_0^n)$$

*is defined by the correspondence  $y \mapsto y \times e^n$ .*

Now recall the statement of Thom's theorem. Let  $\xi$  be an  $n$ -plane bundle with projection  $\pi: E \rightarrow B$ .

**ISOMORPHISM THEOREM 10.2.** *There is one and only one cohomology class  $u \in H^n(E, E_0)$  with mod 2 coefficients whose restriction to  $H^n(F, F_0)$  is non-zero for every fiber  $F$ . Furthermore the correspondence  $y \mapsto y \cup u$  maps the cohomology group  $H^j(E)$  isomorphically onto  $H^{j+n}(E, E_0)$  for every integer  $j$ .*

In particular, taking  $j < 0$ , it follows that the cohomology of the pair  $(E, E_0)$  is trivial in dimensions less than  $n$ .

The proof will be divided into four cases.

**Case 1.** Suppose that  $\xi$  is a trivial vector bundle. Then we will identify  $E$  with the product  $B \times \mathbb{R}^n$ . Thus the cohomology  $H^n(E, E_0) =$

$H^n(B \times \mathbb{R}^n, B \times \mathbb{R}_0^n)$  is canonically isomorphic to  $H^0(B)$  by 10.1. To prove the existence and uniqueness of  $u$ , it suffices to show that there is one and only one cohomology class  $s \in H^0(B)$  whose restriction to each point of  $B$  is non-zero. Evidently the identity element  $1 \in H^0(B)$  is the only class satisfying this condition. Therefore  $u$  exists and is equal to  $1 \times e^n$ .

Finally, since every cohomology class in  $H^j(B \times \mathbb{R}^n)$  can be written uniquely as a product  $y \times 1$  with  $y \in H^j(B)$ , it follows from 10.1 that the correspondence

$$y \times 1 \mapsto (y \times 1) \cup u = (y \times 1) \cup (1 \times e^n) = y \times e^n$$

is an isomorphism. This completes the proof in Case 1.

Case 2. Suppose that  $B$  is the union of two open sets  $B'$  and  $B''$ , where the assertion of 10.2 is known to be true for the restrictions  $\xi|_{B'}$  and  $\xi|_{B''}$  and also for  $\xi|_{B' \cap B''}$ . We introduce the abbreviation  $B^\cap$  for  $B' \cap B''$ , and the abbreviations  $E'$ ,  $E''$  and  $E^\cap$  for the inverse images of  $B'$ ,  $B''$  and  $B' \cap B''$  in the total space. The following Mayer-Vietoris sequence will be used:

$$\dots \rightarrow H^{i-1}(E^\cap, E_0^\cap) \rightarrow H^i(E, E_0) \rightarrow H^i(E', E_0') \oplus H^i(E'', E_0'') \rightarrow H^i(E^\cap, E_0^\cap) \rightarrow \dots$$

For the construction of this sequence, the reader is referred, for example, to [Spanier, pp. 190, 239].

By hypothesis, there exist unique cohomology classes  $u' \in H^n(E', E_0')$  and  $u'' \in H^n(E'', E_0'')$  whose restrictions to each fiber are non-zero. Applying the uniqueness statement for  $\xi|_{B' \cap B''}$ , we see that these classes  $u'$  and  $u''$  have the same image in  $H^n(E^\cap, E_0^\cap)$ . Therefore they come from a common cohomology class  $u$  in  $H^n(E, E_0)$ . This class  $u$  is uniquely defined, since  $H^{n-1}(E^\cap, E_0^\cap) = 0$ .

Now consider the Mayer-Vietoris sequence

$$\dots \rightarrow H^{j-1}(E^\cap) \rightarrow H^j(E) \rightarrow H^j(E') \oplus H^j(E'') \rightarrow H^j(E^\cap) \rightarrow \dots$$

where  $j + n = i$ . Mapping this sequence to the previous Mayer-Vietoris sequence by the correspondence  $y \mapsto y \cup u$  and applying the Five Lemma, it follows that

$$H^j(E) \xrightarrow{\cong} H^{j+n}(E, E_0) .$$

This completes the proof in Case 2.

*Case 3.* Suppose that  $B$  is covered by finitely many open sets  $B_1, \dots, B_k$  such that the bundle  $\xi|_{B_i}$  is trivial for each  $B_i$ . We will prove by induction on  $k$  that the assertion of 10.2 is true for the bundle  $\xi$ .

To start the induction, the assertion is certainly true when  $k = 1$ . If  $k > 1$ , then we can assume by induction that the assertion is true for  $\xi|(B_1 \cup \dots \cup B_{k-1})$  and for  $\xi|(B_1 \cup \dots \cup B_{k-1}) \cap B_k$ . Hence, by Case 2, it is true for  $\xi$ .

*General Case.* Let  $C$  be an arbitrary compact subset of the base space  $B$ . Then evidently the bundle  $\xi|_C$  satisfies the hypothesis of Case 3. Since the union of any two compact sets is compact\* we can form the direct limit

$$\lim_{\rightarrow} H_j(C)$$

of homology groups as  $C$  varies over all compact subsets of  $B$ , and the corresponding inverse limit  $\lim_{\leftarrow} H^j(C)$  of cohomology groups. We recall the following.

LEMMA 10.3. *The natural homomorphism*

$$H^j(B) \rightarrow \lim_{\leftarrow} H^j(C)$$

*is an isomorphism, and similarly  $H^j(E, E_0)$  maps isomorphically to  $\lim_{\leftarrow} H^j(\pi^{-1}(C), \pi^{-1}(C)_0)$ .*

\* Here we are implicitly assuming that the base space  $B$  is Hausdorff. This is not actually necessary. The proof goes through perfectly well for non-Hausdorff spaces provided that one substitutes "quasi-compact" (i.e., every open covering contains a finite covering) for "compact" throughout.

*Caution.* These statements are only true since we are working with field coefficients. The corresponding statements with integer coefficients would definitely be false.

*Proof of 10.3.* The corresponding homology statement, that  $\varinjlim H_j(C)$  maps isomorphically to  $H_j(B)$ , is clearly true for arbitrary coefficients, since every singular chain on  $B$  is contained in some compact subset of  $B$ . Similarly, the group  $\varinjlim H_j(\pi^{-1}(C), \pi^{-1}(C)_0)$  maps isomorphically to  $H_j(E, E_0)$ . But according to A.1 in the Appendix, the cohomology  $H^j(B)$  with coefficients in the field  $\mathbb{Z}/2$  is canonically isomorphic to  $\text{Hom}(H_j(B), \mathbb{Z}/2)$ . Together with the easily verified isomorphism

$$\text{Hom}(\varinjlim H_j(C), \mathbb{Z}/2) \xrightarrow{\cong} \varprojlim \text{Hom}(H_j(C), \mathbb{Z}/2) ,$$

this proves 10.3. ■

In particular, the cohomology group  $H^n(E, E_0)$  maps isomorphically to the inverse limit of the groups  $H^n(\pi^{-1}(C), \pi^{-1}(C)_0)$ . But each of the latter groups contains one and only one class  $u_C$  whose restriction to each fiber is non-zero. It follows immediately that  $H^n(E, E_0)$  contains one and only one class  $u$  whose restriction to each fiber is non-zero.

Now consider the homomorphism  $Uu : H^j(E) \rightarrow H^{j+n}(E, E_0)$ . Evidently, for each compact subset  $C$  of  $B$  there is a commutative diagram

$$\begin{array}{ccc} H^j(E) & \xrightarrow{Uu} & H^{j+n}(E, E_0) \\ \downarrow & & \downarrow \\ H^j(\pi^{-1}(C)) & \longrightarrow & H^{j+n}(\pi^{-1}(C), \pi^{-1}(C)_0) . \end{array}$$

Passing to the inverse limit, as  $C$  varies over all compact subsets, it follows that  $Uu$  is itself an isomorphism. This completes the proof of 10.2. Hence we have finally completed the proof of existence (and uniqueness) for Stiefel-Whitney classes. ■

Now let us try to carry out analogous arguments with coefficients in an arbitrary ring  $\Lambda$ . (It is of course always assumed that  $\Lambda$  is associative with 1.) Just as in the argument above, the cohomology  $H^n(\mathbb{R}^n, \mathbb{R}_0^n; \Lambda)$  is a free  $\Lambda$ -module, with a single generator  $e^n = e^1 \times \dots \times e^1$ . (See A.5 in the Appendix.)

Let  $\xi$  be an oriented  $n$ -plane bundle. Then for each fiber  $F$  of  $\xi$  we are given a preferred generator

$$u_F \in H^n(F, F_0; \mathbb{Z}) .$$

(Compare §9.) Using the unique ring homomorphism  $\mathbb{Z} \rightarrow \Lambda$ , this gives rise to a corresponding generator for  $H^n(F, F_0; \Lambda)$  which will also be denoted by the symbol  $u_F$ .

**ISOMORPHISM THEOREM 10.4.** *There is one and only one cohomology class  $u \in H^n(E, E_0; \Lambda)$  whose restriction to  $(F, F_0)$  is equal to  $u_F$  for every fiber  $F$ . Furthermore the correspondence  $y \mapsto y \cup u$  maps  $H^j(E; \Lambda)$  isomorphically onto  $H^{j+n}(E, E_0; \Lambda)$  for every integer  $j$ .*

If the coefficient ring  $\Lambda$  is a field, then the proof is completely analogous to the proof of 10.2. Details will be left to the reader. Similarly, if the base space  $B$  is compact, then the proof is completely analogous to the proof of 10.2. (A similar argument works for any bundle  $\xi$  of finite type. Compare Problem 5-E.)

The difficulty in extending to the general case is that Lemma 10.3 is not available for cohomology with non-field coefficients. In fact the inverse limits of 10.3 can be very badly behaved in general. However the construction of the fundamental class  $u$  does go through without too much difficulty. We will need the following.

**LEMMA 10.5.** *The homology group  $H_{n-1}(E, E_0; \mathbb{Z})$  is zero.*

Assuming this for the present, it follows from A.1 in the Appendix that the cohomology group  $H^n(E, E_0; \mathbb{Z})$  is canonically isomorphic to  $\text{Hom}(H_n(E, E_0; \mathbb{Z}), \mathbb{Z})$ . Therefore, just as in the proof of 10.3, we see that  $H^n(E, E_0; \mathbb{Z})$  is canonically isomorphic to the inverse limit of the groups

$$H^n(\pi^{-1}(C), \pi^{-1}(C)_0; \mathbb{Z})$$

as  $C$  varies over all compact subsets of the base space  $B$ . Since 10.4 has already been proved for any vector bundle over a compact base space  $C$ , it follows that there is a unique fundamental cohomology class  $u \in H^n(E, E_0; \mathbb{Z})$ .

REMARK. It is important to note that the fundamental class in  $H^n(E, E_0; \mathbb{Z})$  corresponds to a fundamental class in  $H^n(E, E_0; \Lambda)$  for any ring  $\Lambda$ , under the unique ring homomorphism  $\mathbb{Z} \rightarrow \Lambda$ .

To prove that the cup product with  $u$  induces cohomology isomorphisms, we will make use of the following formal constructions.

DEFINITION. A free chain complex over  $\mathbb{Z}$  is a sequence of free  $\mathbb{Z}$ -modules  $K_n$  and homomorphisms

$$\dots \longrightarrow K_n \xrightarrow{\partial} K_{n-1} \xrightarrow{\partial} K_{n-2} \longrightarrow \dots$$

with  $\partial \circ \partial = 0$ . A chain mapping  $f: K \rightarrow K'$  of degree  $d$  is a sequence of homomorphisms  $K_i \rightarrow K'_{i+d}$  satisfying  $\partial' \circ f = (-1)^d f \circ \partial$ .

LEMMA 10.6. Let  $f: K \rightarrow K'$  be a chain mapping, where  $K$  and  $K'$  are free chain complexes over  $\mathbb{Z}$ . If  $f$  induces a cohomology isomorphism

$$f^*: H^*(K'; \Lambda) \rightarrow H^*(K; \Lambda)$$

for every coefficient field  $\Lambda$ , then  $f$  induces isomorphisms of homology and cohomology with arbitrary coefficients.



*Proof.* The *mapping cone*  $K^f$  is a free chain complex constructed as follows. Let  $K_i^f = K_{i-d-1} \oplus K'_i$ , with boundary homomorphism  $\partial^f: K_i^f \rightarrow K_{i-1}^f$  defined by

$$\partial^f(\kappa, \kappa') = ((-1)^{d+1} \partial \kappa, f(\kappa) + \partial' \kappa') .$$

(Compare [Spanier, p. 166].) Evidently  $K^f$  fits into a short exact sequence

$$0 \rightarrow K' \rightarrow K^f \rightarrow K \rightarrow 0$$

of chain mappings. Furthermore the boundary homomorphism

$$\partial^f: H_{i-d-1}(K) \rightarrow H_{i-1}(K')$$

in the associated homology exact sequence is precisely equal to  $f_*$ .

Thus the homology  $H_*(K^f)$  is zero if and only if  $f$  induces an isomorphism  $H_*(K) \rightarrow H_*(K')$  of integral homology.

In our case,  $f$  is known to induce a cohomology isomorphism  $H^*(K'; \Lambda) \rightarrow H^*(K; \Lambda)$  for every coefficient field  $\Lambda$ . Using the cohomology exact sequence, it follows that  $H^*(K^f; \Lambda) = 0$ . But the cohomology  $H^n(K^f; \Lambda)$  is canonically isomorphic to  $\text{Hom}_\Lambda(H_n(K^f \otimes \Lambda), \Lambda)$  by A.1 in the Appendix. Therefore, the homology vector space  $H_n(K^f \otimes \Lambda)$  is zero. For otherwise there would exist a non-trivial  $\Lambda$ -linear mapping from this space to the coefficient field  $\Lambda$ .

In particular the rational homology  $H_n(K^f \otimes \mathbb{Q})$  is zero. Therefore, for every cycle  $\zeta \in Z_n(K^f)$  it follows that some integral multiple of  $\zeta$  is a boundary. Hence the integral homology  $H_n(K^f)$  is a torsion group.

To prove that this torsion group  $H_n(K^f)$  is zero, it suffices to prove that every element of prime order is zero. Let  $\zeta \in Z_n(K^f)$  be a cycle representing a homology class of prime order  $p$ . Then

$$p\zeta = \partial \kappa$$

for some  $\kappa \in K_{n+1}^f$ . Thus  $\kappa$  is a cycle modulo  $p$ . Since the homology  $H_{n+1}(K^f \otimes \mathbb{Z}/p)$  is known to be zero, it follows that  $\kappa$  is a boundary mod  $p$ , say

$$\kappa = \partial \kappa' + p\kappa'' .$$

Therefore  $p\zeta = \partial\kappa$  is equal to  $p\partial\kappa''$ , and hence  $\zeta = \partial\kappa''$ . Thus  $\zeta$  represents the trivial homology class, and we have proved that  $H_*(K^f) = 0$ .

It now follows easily that  $K^f$  has trivial homology and cohomology with arbitrary coefficients. (Compare [Spanier, p. 167].) For example since  $Z_{n-1}(K^f)$  is free, the exact sequence

$$0 \rightarrow Z_n(K^f) \rightarrow K_n^f \rightarrow Z_{n-1}(K^f) \rightarrow 0$$

is split exact, and therefore remains exact when we tensor it with an arbitrary additive group  $\Lambda$ . It follows easily that the sequence

$$\dots \rightarrow K_{n+1}^f \otimes \Lambda \rightarrow K_n^f \otimes \Lambda \rightarrow K_{n-1}^f \otimes \Lambda \rightarrow \dots$$

is also exact, which proves that  $H_*(K^f \otimes \Lambda) = 0$ . This completes the proof of 10.6. ■

The proof of 10.4 now proceeds as follows. We will make use of the cap product operation. (For the definition and basic properties, see Appendix A, p. 276.) While proving 10.4, we will simultaneously prove the following. The coefficient ring  $Z$  is to be understood.

**COROLLARY 10.7.** *The correspondence  $\eta \mapsto u \cap \eta$  defines an isomorphism from the integral homology group  $H_{n+i}(E, E_0)$  to  $H_i(E)$ .*

*Proof.* Choose a singular cocycle  $z \in Z^n(E, E_0)$  representing the fundamental cohomology class  $u$ . Then the correspondence  $\gamma \mapsto z \cap \gamma$  from  $C_{n+i}(E, E_0)$  to  $C_i(E)$  satisfies the identity

$$\partial(z \cap \gamma) = (-1)^n z \cap (\partial\gamma) .$$

Therefore

$$z \cap : C_*(E, E_0) \rightarrow C_*(E)$$

is a chain mapping of degree  $-n$ . Using the identity

$$\langle c, z \cap \gamma \rangle = \langle c \cup z, \gamma \rangle$$

we see that the induced cochain mapping

$$(z \cap)^{\#} : C^*(E; \Lambda) \rightarrow C^*(E, E_0; \Lambda)$$

is given by  $c \mapsto c \cup z$ . Here  $\Lambda$  can be any ring. If the coefficient ring  $\Lambda$  is a field, then this cochain mapping induces a cohomology isomorphism by the portion of 10.4 which has already been proved. Thus we can apply 10.6, and conclude that the homomorphisms

$$u \cap : H_{i+n}(E, E_0; \Lambda) \rightarrow H_i(E; \Lambda)$$

and

$$Uu : H^i(E; \Lambda) \rightarrow H^{i+n}(E, E_0; \Lambda)$$

are actually isomorphisms for arbitrary  $\Lambda$ . In particular, using the isomorphism  $Uu : H^0(E; \Lambda) \rightarrow H^n(E, E_0; \Lambda)$ , the uniqueness of the fundamental cohomology class  $u$  with coefficients in  $\Lambda$  can now be verified.

This completes the proof of 10.4 and 10.7 except for one step which has been skipped over. Namely, we must still prove that  $H_{n-1}(E, E_0; \mathbb{Z}) = 0$  (Lemma 10.5).

First suppose that the base space  $B$  is compact. Then we have already observed that Theorem 10.4 is true independently of 10.5. Similarly the proof of 10.7, in this special case, goes through without making use of 10.5. Thus we are free to make use of 10.7 to conclude that

$$H_{n-1}(E, E_0; \mathbb{Z}) \xrightarrow{\cong} H_{-1}(E; \mathbb{Z}) = 0 .$$

The proof of 10.5 in the general case now follows immediately, using the homology isomorphism

$$\lim_{\rightarrow} H_i(\pi^{-1}(C), \pi^{-1}(C)_0; \mathbb{Z}) \xrightarrow{\cong} H_i(E, E_0; \mathbb{Z}) ,$$

where  $C$  varies over all compact subsets of  $B$ . (Compare 10.3.) This completes the proof. ■

## §11. Computations in a Smooth Manifold

### The Normal Bundle

Let  $M = M^n$  be a smooth manifold which is smoothly (and topologically) embedded in a Riemannian manifold  $A = A^{n+k}$ . In order to study characteristic classes of the normal bundle of  $M$  in  $A$  we will need the following geometrical result.

**TUBULAR NEIGHBORHOOD THEOREM 11.1.** *There exists an open neighborhood of  $M$  in  $A$  which is diffeomorphic to the total space of the normal bundle under a diffeomorphism which maps each point  $x$  of  $M$  to the zero normal vector at  $x$ .*

Such a neighborhood is called an open *tubular neighborhood* of  $M$  in  $A$ .

To simplify the presentation, we will carry out full details of the proof only in the special case where  $M$  is compact. This special case will suffice for nearly all of our applications. The proof in the general case is given, for example, in [Lang].

Let  $E$  denote the total space of the normal bundle  $\nu^k$ . To any real number  $\varepsilon > 0$ , we associate the open subset  $E(\varepsilon) \subset E$  consisting of all pairs  $(x, v) \in E$  with  $|v| < \varepsilon$ . Here  $x$  denotes a point of  $M$ , and  $v$  a normal vector to  $M$  at  $x$ .

[Or more generally, to any smooth real valued function  $x \mapsto \varepsilon(x) > 0$ , we can associate the open set  $E(\varepsilon)$  consisting of all  $(x, v) \in E$  with  $|v| < \varepsilon(x)$ . This more general construction is essential in dealing with non-compact manifolds.]

We will make use of the "exponential map"

$$\text{Exp} : E(\varepsilon) \rightarrow A$$

of Riemannian geometry, which assigns to each  $(x, v) \in E$  with  $|v|$  sufficiently small the endpoint  $\gamma(1)$  of the parametrized geodesic arc

$$\gamma : [0, 1] \rightarrow A$$

of length  $|v|$  having initial point  $\gamma(0)$  equal to  $x$  and initial velocity vector  $dy/dt|_{t=0}$  equal to  $v$ . As an example, if the ambient Riemannian manifold  $A$  is Euclidean space, then  $\gamma$  is just a straight line segment, and the exponential map is given by the formula  $\text{Exp}(x, v) = x + v$ .

The usual existence, uniqueness, and smoothness theorems for differential equations imply that  $\text{Exp}(x, v)$  is defined, and smooth as a function of  $(x, v)$ , throughout some neighborhood of the zero cross-section  $M \times 0 \subset E$ . (See for example [Bishop and Crittenden].) It follows easily that  $\text{Exp}$  is defined and smooth on  $E(\varepsilon)$  for  $\varepsilon$  sufficiently small.

Furthermore, applying the Inverse Function Theorem at any point  $(x, 0)$  on the zero cross-section, we see that some open neighborhood of  $(x, 0)$  in  $E(\varepsilon)$  is mapped diffeomorphically onto an open subset of  $A$ .

*ASSERTION. If  $\varepsilon$  is sufficiently small, then the entire open set  $E(\varepsilon)$  is mapped diffeomorphically onto an open set  $N_\varepsilon \subset A$  by the exponential map.*

*Proof, assuming that  $M$  is compact.* Certainly the exponential map restricted to  $E(\varepsilon)$  is a local diffeomorphism, for small  $\varepsilon$ , so it suffices to prove that it is one-to-one. If this were false, then for each integer  $i > 0$ , taking  $\varepsilon = 1/i$ , there would exist two distinct points

$$(x_i, v_i) \neq (x'_i, v'_i)$$

in the neighborhood  $E(1/i)$  for which

$$\text{Exp}(x_i, v_i) = \text{Exp}(x'_i, v'_i) .$$

Therefore, since  $M$  is compact, there would exist a convergent subsequence  $\{x_{i_j}\}$  so that say

$$\lim (x_{i_j}, v_{i_j}) = (x, 0) ,$$

and simultaneously

$$\lim (x'_{i_j}, v'_{i_j}) = (x', 0) .$$

Evidently the limit point  $x = \text{Exp}(x, 0) = \lim \text{Exp}(x_{i_j}, v_{i_j})$  would be equal to the limit point  $x'$ . But then the equation  $\text{Exp}(x_{i_j}, v_{i_j}) = \text{Exp}(x'_{i_j}, v'_{i_j})$  for large  $j$  would contradict the statement that  $\text{Exp}$  is one-to-one throughout a neighborhood of  $(x, 0)$ .

Thus  $E(\varepsilon)$  is diffeomorphic to its image  $N_\varepsilon$  for small  $\varepsilon$ . To complete the proof of 11.1, we need only note that  $E(\varepsilon)$  is also diffeomorphic to  $E$ , under the correspondence

$$(x, v) \mapsto (x, v/\sqrt{1-|v|^2/\varepsilon(x)^2}) . \blacksquare$$

Now let us make the additional hypothesis that the submanifold  $M \subset A$  is closed as a subset of the topological space  $A$ . Of course this hypothesis is automatically satisfied if  $M$  is compact.

**COROLLARY 11.2.** *If  $M$  is closed in  $A$ , then the cohomology ring  $H^*(E, E_0; \Lambda)$  associated with the normal bundle of  $M$  in  $A$  is canonically isomorphic to the cohomology ring  $H^*(A, A-M; \Lambda)$ .*

Here  $\Lambda$  can be any coefficient ring.

*Proof.* Since the tubular neighborhood  $N_\varepsilon$  and the complement  $A-M$  are open subsets with union  $A$  and intersection  $N_\varepsilon - M$ , there is an excision isomorphism

$$H^*(A, A-M) \rightarrow H^*(N_\varepsilon, N_\varepsilon - M) .$$

(See for example [Spanier].) Therefore the embedding

$$\text{Exp} : (E(\varepsilon), E(\varepsilon)_0) \rightarrow (N_\varepsilon, N_\varepsilon - M) \subset (A, A - M)$$

induces an isomorphism

$$\text{Exp}^* : H^*(A, A - M) \rightarrow H^*(E(\varepsilon), E(\varepsilon)_0) .$$

Composing with the excision isomorphism

$$H^*(E(\varepsilon), E(\varepsilon)_0) \cong H^*(E, E_0)$$

we obtain an isomorphism which clearly does not depend on the particular choice of  $\varepsilon$ . ■

REMARK. This isomorphism  $H^*(A, A - M) \rightarrow H^*(E, E_0)$  does not even depend on the particular choice of Riemannian metric for  $A$ . To make sense of this statement, one must first choose a definition of "normal bundle," based on the exact sequence

$$0 \rightarrow \tau_M \rightarrow \tau_A|_M \rightarrow \nu^k \rightarrow 0 ,$$

which is independent of the particular Riemannian metric on  $A$ . (Compare Problem 3-B.) Since any two Riemannian metrics  $\mu_0$  and  $\mu_1$  can be joined by a smooth one-parameter family of Riemannian metrics  $(1-t)\mu_0 + t\mu_1$ , it then follows easily that the corresponding exponential maps are homotopic.

As an application of 11.2, the fundamental cohomology class  $u \in H^k(E, E_0; \mathbb{Z}/2)$  corresponds to a canonical cohomology class which we denote by the symbol

$$u' \in H^k(A, A - M; \mathbb{Z}/2) .$$

Similarly if the normal bundle  $\nu^k$  is orientable, then any specific orientation for  $\nu^k$  determines a corresponding class  $u' \in H^k(A, A - M; \mathbb{Z})$  with integer coefficients.

**THEOREM 11.3.** *If  $M$  is embedded as a closed subset of  $A$ , then the composition of the two restriction homomorphisms*

$$H^k(A, A-M) \rightarrow H^k(A) \rightarrow H^k(M) ,$$

*with mod 2 coefficients, maps the fundamental class  $u'$  to the top Stiefel-Whitney class  $w_k(\nu^k)$  of the normal bundle. Similarly, if  $\nu^k$  is oriented, then the corresponding composition with integer coefficients maps the integral fundamental class  $u'$  to the Euler class  $e(\nu^k)$ .*

*Proof.* Let  $s : M \rightarrow E$  denote the zero cross-section of  $\nu^k$ , inducing a canonical isomorphism  $H^*(E) \rightarrow H^*(M)$ . First note that the composition

$$H^k(E, E_0) \longrightarrow H^k(E) \xrightarrow{s^*} H^k(M)$$

with mod 2 coefficients maps the fundamental class  $u$  to the Stiefel-Whitney class  $w_k(\nu^k)$ . (Compare §9.5.) In fact the image of  $s^*(u|E)$  under the Thom isomorphism

$$\phi : H^k(M) \rightarrow H^{2k}(E, E_0)$$

is equal to  $\pi^*s^*(u|E) \cup u = (u|E) \cup u = u \cup u = Sq^k(u)$ . Therefore  $s^*(u|E)$  is equal to  $\phi^{-1}Sq^k(u) = w_k(\nu^k)$ .

Now, replacing  $(E, E_0)$  by the diffeomorphic pair  $(N_\varepsilon, N_\varepsilon - M)$ , it follows that the composition of the two restriction homomorphisms

$$H^k(N_\varepsilon, N_\varepsilon - M) \rightarrow H^k(N_\varepsilon) \rightarrow H^k(M)$$

maps the class corresponding to  $u$  to  $w_k(\nu^k)$ . Making use of the commutative diagram

$$\begin{array}{ccc} H^k(A, A-M) & \longrightarrow & H^k(A) \\ \downarrow \cong & & \downarrow \\ H^k(N_\varepsilon, N_\varepsilon - M) & \longrightarrow & H^k(M) , \end{array}$$



the conclusion follows. The proof in the oriented case is completely analogous. ■

DEFINITION. The image of  $u'$  in  $H^k(A)$  is called the *dual cohomology class* to the submanifold  $M$  of codimension  $k$ . (Compare Problem 11-C.) If this dual class  $u'|_A$  is zero, it follows of course that the top Stiefel-Whitney class [or the Euler class] of  $\nu^k$  must also be zero. One special case is particularly noteworthy:

COROLLARY 11.4. *If  $M = M^n$  is smoothly embedded as a closed subset of the Euclidean space  $\mathbb{R}^{n+k}$ , then  $w_k(\nu^k) = 0$ . In the oriented case  $e(\nu^k) = 0$ .*

For the dual class  $u'|_{\mathbb{R}^{n+k}}$  belongs to a cohomology group  $H^k(\mathbb{R}^{n+k})$  which is zero. ■

By the Whitney duality theorem 4.2, the class  $w_k(\nu^k)$  can be expressed as a characteristic class  $\bar{w}_k(\tau_M)$  of the tangent bundle of  $M$ . Thus we can restate 11.4 as follows: *If  $\bar{w}_k(\tau_M) \neq 0$ , then  $M$  cannot be smoothly embedded as a closed subset of  $\mathbb{R}^{n+k}$ .*

As an example, if  $n$  is a power of 2, then the real projective space  $P^n$  cannot be smoothly embedded in  $\mathbb{R}^{2n-1}$ . (Compare §4.8. According to [Whitney, 1944], every smooth  $n$ -manifold whose topology has a countable basis can be smoothly embedded in  $\mathbb{R}^{2n}$ . Presumably it can be embedded as a closed subset of  $\mathbb{R}^{2n}$ , although Whitney does not prove this).

REMARK. It is essential in 11.4 that  $M$  be a manifold *without boundary*, embedded as a closed subset of Euclidean space. For example the open Moebius band of Figure 2 can certainly be embedded in  $\mathbb{R}^3$ . But it cannot be embedded as a closed subset, since the associated Stiefel-Whitney class  $\bar{w}_1(\tau)$  is non-zero. Similarly it is essential that  $M$  be *embedded* (i.e., without self-intersections) rather than simply immersed

in  $\mathbb{R}^{n+k}$ . For example a theorem of [Boy] asserts that the real projective plane  $P^2$  can be immersed in  $\mathbb{R}^3$ . (See [Hilbert and Cohn-Vossen].) But again the dual Steifel-Whitney class  $\bar{w}_1(\tau)$  is non-zero.

### The Tangent Bundle

Let  $M$  be a Riemannian manifold. Then the product  $M \times M$  also has the structure of a Riemannian manifold, the length of a tangent vector

$$(u, v) \in DM_x \times DM_y \cong D(M \times M)_{(x,y)}$$

being defined by

$$|(u, v)|^2 = |u|^2 + |v|^2,$$

and the inner product of two such vectors being defined by

$$(u, v) \cdot (u', v') = u \cdot u' + v \cdot v'.$$

Note that the diagonal mapping

$$x \mapsto \Delta(x) = (x, x)$$

embeds  $M$  smoothly as a closed subset of  $M \times M$ . (This diagonal embedding is almost an isometry: it multiplies all lengths by  $\sqrt{2}$ .)

**LEMMA 11.5.** *The normal bundle  $\nu^n$  associated with the diagonal embedding of  $M$  in  $M \times M$  is canonically isomorphic to the tangent bundle of  $M$ .*

*Proof.* Evidently a vector  $(u, v) \in DM_x \times DM_x \cong D(M \times M)_{(x,x)}$  is tangent to  $\Delta(M)$  if and only if  $u = v$ , and normal to  $\Delta(M)$  if and only if  $u + v = 0$ . Thus each tangent vector  $v \in DM_x$  corresponds uniquely to a normal vector  $(-v, v) \in D(M \times M)_{(x,x)}$ . This correspondence

$$(x, v) \mapsto ((x, x), (-v, v))$$

maps the tangent manifold  $DM = E(\tau_M)$  diffeomorphically onto the total space  $E(\nu^n)$ . ■

We will be particularly interested in Riemannian manifolds  $M$  for which the tangent bundle  $\tau_M$  is oriented.

LEMMA 11.6. *Any orientation for the tangent bundle  $\tau_M$  gives rise to an orientation for the underlying topological manifold  $M$ , and conversely any orientation for  $M$  gives rise to an orientation for  $\tau_M$ .*

*Proof.* As defined in Appendix A, an *orientation* for a topological manifold  $M$  is a function which assigns to each point  $x$  of  $M$  a preferred generator  $\mu_x$  for the infinite cyclic group  $H_n(M, M-x)$ , using integer coefficients. These preferred generators are required to "vary continuously" with  $x$ , in the sense that  $\mu_x$  corresponds to  $\mu_y$  under the isomorphisms

$$H_n(M, M-x) \leftarrow H_n(M, M-N) \rightarrow H_n(M, M-y) ,$$

where  $N$  denotes a nicely embedded  $n$ -cell neighborhood of  $x$  and  $y$  is any point of  $N$ .

Similarly, an orientation for the vector bundle  $\tau_M$  can be specified by assigning a preferred generator  $\mu'_x$  to the infinite cyclic group  $H_n(DM_x, DM_x-0)$  for each  $x$ . These generators  $\mu'_x$  must vary continuously with  $x$ , for example in the sense that  $\mu'_x$  corresponds to  $\mu'_y$  under the isomorphisms

$$H_n(DM_x, DM_x-0) \rightarrow H_n(DN, DN-(N \times 0)) \leftarrow H_n(DM_y, DM_y-0) ,$$

where  $N$  denotes an  $n$ -cell neighborhood and  $y \in N$ . (Compare §9.)

But the homology group  $H_n(M, M-x)$  is canonically isomorphic to  $H_n(DM_x, DM_x-0)$  as one sees by applying 11.2 to the 0-dimensional manifold  $x$ , embedded in  $M$  as a closed subset with normal bundle  $DM_x$ .

The proof that  $\mu_x$  varies continuously with  $x$  if and only if the corresponding generators  $\mu'_x$  vary continuously with  $x$  is not difficult. In fact, since the problem is purely local, it suffices to consider the special case where  $M$  is Euclidean space with the standard metric. Details will be left to the reader. ■

Let us study homology and cohomology of  $M$  with coefficients in some fixed commutative ring  $\Lambda$ . We will always assume either that  $M$  is oriented or that  $\Lambda = \mathbb{Z}/2$ . It follows from 11.2 that there is a fundamental cohomology class

$$u' \in H^n(M \times M, M \times M - \Delta(M))$$

with coefficients in  $\Lambda$ . By 11.3, the restriction of  $u'$  to the diagonal submanifold  $\Delta(M) \cong M$  is equal to the Euler class

$$e(\nu^n) = e(\tau_M)$$

with coefficient ring  $\Lambda$ , in the oriented case, or to the Stiefel-Whitney class  $w_n(\tau_M)$  in the mod 2 case.

This cohomology class  $u'$  can be characterized more explicitly as follows. Note that each cohomology group  $H^n(M, M-x)$  has a preferred generator  $u_x$ , defined by the condition

$$\langle u_x, \mu_x \rangle = 1 .$$

(In the mod 2 case,  $u_x$  is the unique non-zero element of  $H^n(M, M-x)$ .) Define the canonical embedding

$$j_x : (M, M-x) \rightarrow (M \times M, M \times M - \Delta(M))$$

by setting  $j_x(y) = (x, y)$ .

**LEMMA 11.7.** *The class  $u' \in H^n(M \times M, M \times M - \Delta(M))$  is uniquely characterized by the property that its image  $j_x^*(u')$  is equal to the preferred generator  $u_x$  for every  $x \in M$ .*

*Proof.* By its construction (10.4 and 11.2), the cohomology class  $u'$  can be uniquely characterized as follows. For any  $x$  and any small neighborhood  $N$  of zero in the tangent space  $DM_x$ , consider the embedding

$$(N, N-0) \rightarrow (M \times M, M \times M - \Delta(M))$$

defined by the exponential map

$$v \mapsto (\text{Exp}(x, -v), \text{Exp}(x, v)) .$$

Then the induced cohomology homomorphism must map  $u'$  to the preferred generator for the module  $H^n(N, N-0) \cong H^n(DM_x, DM_x-0)$ .

Making use of the homotopy  $v, t \mapsto (\text{Exp}(x, -tv), \text{Exp}(x, v))$  for  $0 \leq t \leq 1$ , it follows that we can equally well use the embedding of  $(N, N-0)$  in  $(M \times M, M \times M - \Delta(M))$  defined by

$$v \mapsto (x, \text{Exp}(x, v)) .$$

Since this is the composition of  $j_x$  with the canonical embedding

$$\text{Exp} : (N, N-0) \rightarrow (M, M-x)$$

which was used to prove 11.6, the conclusion follows. ■

### The Diagonal Cohomology Class in $H^n(M \times M)$

We continue to assume either that  $M$  is oriented or that the coefficient ring  $\Lambda$  is  $\mathbb{Z}/2$ , so that the fundamental class

$$u' \in H^n(M \times M, M \times M - \Delta(M))$$

is defined. Note that the restriction homomorphism

$$H^n(M \times M, M \times M - \Delta(M)) \rightarrow H^n(M \times M)$$

maps  $u'$  to a cohomology class  $u'|_{M \times M}$  which, by definition, is "dual" to the diagonal submanifold of  $M \times M$ .

DEFINITION. This cohomology class  $u' \in H^n(M \times M)$  will be denoted briefly by  $u''$ , and called the *diagonal cohomology class* in  $H^n(M \times M)$ .

We would like to characterize this diagonal cohomology class more explicitly. First, a preliminary lemma which expresses algebraically the fact that  $u''$  is “concentrated” along the diagonal in  $M \times M$ .

LEMMA 11.8. For any cohomology class  $a \in H^*(M)$ , the product  $(a \times 1) \cup u''$  is equal to  $(1 \times a) \cup u''$ .

*Proof.* Let  $N_\epsilon$  be a tubular neighborhood of the diagonal submanifold  $\Delta(M)$  in  $M \times M$ . Evidently  $\Delta(M)$  is a deformation retract of  $N_\epsilon$ . Define the two projection maps

$$p_1, p_2 : M \times M \rightarrow M$$

by  $p_1(x, y) = x$ ,  $p_2(x, y) = y$ . Since  $p_1$  and  $p_2$  coincide on  $\Delta(M)$ , it follows that the restriction  $p_1|_{N_\epsilon}$  is homotopic to  $p_2|_{N_\epsilon}$ . Therefore the two cohomology classes  $p_1^*(a) = a \times 1$  and  $p_2^*(a) = 1 \times a$  have the same image under the restriction homomorphism  $H^i(M \times M) \rightarrow H^i(N_\epsilon)$ . Now, using the commutative diagram

$$\begin{array}{ccc} H^i(M \times M) & \longrightarrow & H^i(N_\epsilon) \\ \downarrow \cup u'' & & \downarrow \cup u'|_{(N_\epsilon, N_\epsilon - \Delta(M))} \\ H^{i+n}(M \times M, M \times M - \Delta(M)) & \cong & H^{i+n}(N_\epsilon, N_\epsilon - \Delta(M)) \end{array} ,$$

it follows that  $(a \times 1) \cup u'' = (1 \times a) \cup u''$ . Restricting to  $H^{i+n}(M \times M)$ , the conclusion follows. ■

We will make use of the *slant product operation*

$$H^{p+q}(X \times Y) \otimes H_q(Y) \rightarrow H^p(X)$$

with coefficients in  $\Lambda$ . In the special case where  $X$  and  $Y$  are finite complexes and  $\Lambda$  is a field, so that

$$H^*(X \times Y) \cong H^*(X) \otimes H^*(Y) ,$$

this slant product can be defined quite easily as follows. Define a homomorphism

$$H^*(X) \otimes H^*(Y) \otimes H_*(Y) \rightarrow H^*(X)$$

by the formula  $a \otimes b \otimes \beta \mapsto a \langle b, \beta \rangle$ . Now, substituting  $H^*(X \times Y)$  for  $H^*(X) \otimes H^*(Y)$ , we have the required operation

$$H^*(X \times Y) \otimes H_*(Y) \rightarrow H^*(X)$$

which is denoted by  $p \otimes \beta \mapsto p/\beta$ . This operation satisfies and is characterized by the identity

$$(a \times b)/\beta = a \langle b, \beta \rangle .$$

For each fixed  $\beta \in H_*(Y)$ , note that the homomorphism  $p \mapsto p/\beta$  is left  $H^*(X)$ -linear in the sense that  $((a \times 1) \cup p)/\beta = a \cup (p/\beta)$  for every  $a \in H^*(X)$  and every  $p \in H^*(X \times Y)$ .

For the definition of slant product in general, the reader is referred to [Spanier] or [Dold].

**LEMMA 11.9.** *Suppose that  $M$  is compact, so that the fundamental homology class  $\mu \in H_n(M)$  is defined. Then the diagonal cohomology class  $u'' \in H^n(M \times M)$  and the fundamental homology class  $\mu$  are related by the identity  $u''/\mu = 1 \in H^0(M)$ .*

We are assuming field coefficients, although the proof would actually go through with any coefficient ring, in the oriented case.

*Proof.* For any  $x \in M$  we will compute the image of  $u''/\mu$  under the restriction homomorphism  $H^0(M) \rightarrow H^0(x) \cong \Lambda$ . We will make use of the commutative diagram

$$\begin{array}{ccc} H^n(M \times M) & \xrightarrow{\quad / \mu \quad} & H^0(M) \\ \downarrow & & \downarrow \\ H^n(x \times M) & \xrightarrow{\quad / \mu \quad} & H^0(x) . \end{array}$$

Note that the left hand vertical arrow maps the cohomology class  $u''$  to  $1 \times i_x^*(u'')$ , where

$$i_x : M \rightarrow M \times M$$

denotes the embedding  $y \mapsto (x, y)$ . Using the identity  $(a \times b)/\mu = a \langle b, \mu \rangle$ , it follows that  $(u''/\mu)|_x$  is equal to the Kronecker index  $\langle i_x^*(u''), \mu \rangle$  multiplied by  $1 \in H^0(x)$ .

As constructed in Appendix A, the fundamental homology class  $\mu$  is uniquely characterized by the property that for each  $x \in M$  the natural homomorphism

$$H_n(M) \rightarrow H_n(M, M-x)$$

maps  $\mu$  to the preferred generator  $\mu_x$ . Making use of the mappings

$$\begin{array}{ccc} M & \subset & (M, M-x) \\ \downarrow i_x & & \downarrow j_x \\ M \times M & \subset & (M \times M, M \times M - \Delta(M)) \end{array} ,$$

where  $j_x$  also sends  $y$  to  $(x, y)$ , it follows from this defining property of  $\mu$  that the Kronecker index  $\langle i_x^*(u''), \mu \rangle = \langle j_x^*(u')|_M, \mu \rangle$  is equal to  $\langle j_x^*(u'), \mu_x \rangle$ . Since this equals 1 by 11.7, we have proved that

$$(u''/\mu)|_x = 1 \in H^0(x) .$$

This is true for every  $x$ , so it clearly follows that  $u''/\mu$  is equal to the identity element of  $H^0(M)$ . ■

### Poincaré Duality and the Diagonal Class

Let  $M$  be a compact smooth manifold. We will study the cohomology of  $M$  with coefficients in a field  $\Lambda$ , continuing to assume either that  $M$  is oriented or that  $\Lambda = \mathbb{Z}/2$ .



DUALITY THEOREM 11.10. To each basis  $b_1, \dots, b_r$  for  $H^*(M)$  there corresponds a dual basis  $b_1^\#, \dots, b_r^\#$  for  $H^*(M)$ , satisfying the identity

$$\begin{aligned} \langle b_i \cup b_j^\#, \mu \rangle &= 1 \quad \text{for } i = j, \\ &= 0 \quad \text{for } i \neq j. \end{aligned}$$

It follows as a corollary that the rank of the vector space  $H^k(M)$  is equal to the rank of  $H^{n-k}(M)$ . For if a basis element  $b_i$  has dimension  $k$  then the dual basis element  $b_i^\#$  must have dimension  $n - k$ . In fact it follows that the vector space  $H^k(M)$  is isomorphic to the dual vector space  $\text{Hom}_\Lambda(H^{n-k}(M), \Lambda)$ , using the correspondence  $a \mapsto h_a$  where  $h_a(b) = \langle a \cup b, \mu \rangle$ . (For other formulations of Poincaré duality, see Problem 11-B and Appendix A, as well as [Spanier], [Dold].)

While proving 11.10, we will simultaneously give a precise description of the cohomology class  $u'' \in H^n(M \times M)$ .

THEOREM 11.11. With  $\{b_i\}$  and  $\{b_i^\#\}$  as above, the diagonal cohomology class  $u''$  is equal to

$$\sum_{i=1}^r (-1)^{\dim b_i} b_i \times b_i^\#.$$

*Proof of 11.10 and 11.11.* Using the Kunneth formula

$$H^*(M \times M) \cong H^*(M) \otimes H^*(M),$$

it follows easily that the diagonal class can be expressed as an  $r$ -fold sum

$$u'' = b_1 \times c_1 + \dots + b_r \times c_r,$$

where  $c_1, \dots, c_r$  are certain well defined cohomology classes in  $H^*(M)$  with

$$\dim b_i + \dim c_i = n.$$

Let us apply the homomorphism  $/\mu$  to both sides of the identity

$$(a \times 1) \cup u'' = (1 \times a) \cup u'' .$$

On the left side, using the left linearity of the slant product, we obtain

$$((a \times 1) \cup u'')/\mu = a \cup (u''/\mu) = a .$$

On the right side, substituting  $\sum b_j \times c_j$  for  $u''$ , we obtain

$$\begin{aligned} & \sum (-1)^{\dim a \dim b_j} (b_j \times (a \cup c_j))/\mu \\ &= \sum (-1)^{\dim a \dim b_j} b_j \langle a \cup c_j, \mu \rangle . \end{aligned}$$

Hence this last expression must be equal to  $a$ . Substituting  $b_i$  for  $a$ , it follows that the coefficient

$$(-1)^{\dim b_i \dim b_j} \langle b_i \cup c_j, \mu \rangle$$

of  $b_j$  must be  $+1$  for  $i = j$ , and  $0$  for  $i \neq j$ . Setting  $b_i^\# = (-1)^{\dim b_i} c_i$ , the conclusions follow easily. ■

### Euler Class and Euler Characteristic

The *Euler characteristic* of a finite complex  $K$  is defined as the alternating sum

$$\chi(K) = \sum (-1)^k \text{rank } H^k(K) ,$$

using field coefficients. A familiar theorem asserts that this is equal to the alternating sum

$$\sum (-1)^k (\text{number of } k\text{-cells}) ,$$

and hence is independent of the particular coefficient field which is used. (Compare [Dold, pp. 105, 156].)

**COROLLARY 11.12.** *If  $M$  is a smooth compact oriented manifold, then the Kronecker index  $\langle e(\tau_M), \mu \rangle$ , using rational or integer coefficients, is equal to the Euler characteristic  $\chi(M)$ . Similarly, for a non-oriented manifold, the Stiefel-Whitney number  $\langle w_n(\tau_M), \mu \rangle = w_n[M]$  is congruent to  $\chi(M)$  modulo 2.*

*Proof.* By 11.3 and 11.5 the Euler class of the tangent bundle is given by

$$e(\tau_M) = \Delta^*(u'') .$$

Using rational coefficients, we can substitute the formula

$$u'' = \sum (-1)^{\dim b_i} b_i \times b_i^\# ,$$

thus obtaining

$$e(\tau_M) = \sum (-1)^{\dim b_i} b_i \cup b_i^\# .$$

Now applying the homomorphism  $\langle , \mu \rangle$  to both sides, we obtain the required formula

$$\langle e(\tau_M), \mu \rangle = \sum (-1)^{\dim b_i} = \chi(M) .$$

The mod 2 argument is completely analogous. ■

### Wu's Formula for Stiefel-Whitney Classes

Let  $w_i = w_i(\tau_M)$  be the  $i$ -th Stiefel-Whitney class of the tangent bundle of a smooth manifold  $M$ , or equivalently the  $i$ -th Stiefel-Whitney class of the normal bundle of the diagonal in  $M \times M$ . Applying Thom's formula (p. 91)

$$Sq^i(u) = (\pi^* w_i) \cup u$$

together with the isomorphism

$$H^*(E, E_0) \cong H^*(N_\varepsilon, N_\varepsilon - \Delta(M)) \cong H^*(M \times M, M \times M - \Delta(M))$$

of 11.2, it follows easily that

$$Sq^i(u') = (w_i \times 1) \cup u' .$$

Therefore, restricting to  $H^*(M \times M)$ , we obtain  $Sq^i(u'') = (w_i \times 1) \cup u''$ .

We will again make use of the fact that the slant product homomorphism

$$/\beta : H^*(X \times Y) \rightarrow H^*(X)$$

is left  $H^*(X)$ -linear for any  $\beta \in H_*(Y)$ . In particular, the slant product

$$((w_i \times 1) \cup u'')/\mu$$

is equal to

$$w_i \cup (u''/\mu) = w_i ,$$

(Compare the proof of 11.11.) Since this is equal to  $Sq^i(u'')/\mu$ , we have the following.

**LEMMA 11.13.** *If  $M$  is compact and smooth, then the Stiefel-Whitney classes of  $\tau_M$  are given by the formula  $w_i = Sq^i(u'')/\mu$ .*

As a corollary, if two manifolds  $M_1$  and  $M_2$  have the same homotopy type, then their Stiefel-Whitney classes must correspond under the resulting isomorphism  $H^*(M_1) \cong H^*(M_2)$ . This follows since the class  $u''$  is determined by 11.11.

In fact, following Wu Wen-Tsün, one can work out an explicit recipe for computing  $w_i$ , given only the mod 2 cohomology ring  $H^*(M)$  and the action of the Steenrod squares on  $H^*(M)$ . Consider the additive homomorphism

$$x \mapsto \langle Sq^k(x), \mu \rangle$$

from  $H^{n-k}(M)$  to  $\mathbb{Z}/2$ . Using the Duality Theorem, there clearly exists one and only one cohomology class

$$v_k \in H^k(M)$$

which satisfies the identity

$$\langle v_k \cup x, \mu \rangle = \langle \text{Sq}^k(x), \mu \rangle$$

for every  $x$ . [In fact, if one considers  $M$  as the disjoint union of its connected components, then it is easy to check that  $v_k$  satisfies the sharper condition

$$v_k \cup x = \text{Sq}^k(x) \in H^n(M)$$

for every  $x \in H^{n-k}(M)$ . Of course the class  $v_k$  is zero whenever  $k > n-k$ ].

We define the *total Wu class*

$$v \in H^\Pi(M) = H^0(M) \oplus H^1(M) \oplus \dots \oplus H^n(M)$$

to be the formal sum

$$v = 1 + v_1 + \dots + v_n .$$

Clearly  $v$  satisfies and is characterized by the identity

$$\langle v \cup x, \mu \rangle = \langle \text{Sq}(x), \mu \rangle ,$$

which holds for every cohomology class  $x$ . Here  $\text{Sq}$  denotes the total squaring operation  $\text{Sq}^0 + \text{Sq}^1 + \text{Sq}^2 + \dots$ .

**THEOREM 11.14 (Wu).** *The total Stiefel-Whitney class  $w$  of  $r_M$  is equal to  $\text{Sq}(v)$ . In other words*

$$w_k = \sum_{i+j=k} \text{Sq}^i(v_j) .$$

*Proof.* Choose a basis  $\{b_i\}$  for the mod 2 cohomology  $H^*(M)$  and a dual basis  $\{b_i^\#\}$ , as in 11.10. Then for any cohomology class  $x$  in  $H^\Pi(M)$  the identity

$$x = \sum b_i \langle x \cup b_i^\#, \mu \rangle$$

is easily verified. Applying this identity to the total Wu class  $v$  we obtain

$$\begin{aligned} v &= \sum b_i \langle v \cup b_i^\#, \mu \rangle \\ &= \sum b_i \langle \text{Sq}(b_i^\#), \mu \rangle . \end{aligned}$$

Therefore  $\text{Sq}(v)$  is equal to

$$\begin{aligned} &\sum \text{Sq}(b_i) \langle \text{Sq}(b_i^\#), \mu \rangle \\ &= \sum (\text{Sq}(b_i) \times \text{Sq}(b_i^\#)) / \mu \\ &= \text{Sq}(u^\sim) / \mu \end{aligned}$$

by 11.11. Hence  $\text{Sq}(v) = w$  as required. ■

Here is a concrete application to illustrate Wu's theorem. Let  $M$  be a compact manifold whose mod 2 cohomology ring is generated by a single element  $a \in H^k(M)$ , with  $k \geq 1$ . Thus the cohomology  $H^*(M)$  has basis  $\{1, a, a^2, \dots, a^m\}$ , and the dimension of  $M$  must be equal to  $km$ , for some integer  $m \geq 1$ .

**COROLLARY 11.15.** *With  $M$  as above, the total Stiefel-Whitney class  $w(\tau_M)$  is equal to  $(1+a)^{m+1} = 1 + \binom{m+1}{1}a + \dots + \binom{m+1}{m}a^m$ .*

As an example, the hypothesis of 11.15 is certainly satisfied for the sphere  $S^k$ , with  $m = 1$  and  $w = (1+a)^2 = 1$ . It is also satisfied for the real projective space  $P^m = P^m(\mathbb{R})$ , with cohomology generator  $a$  in dimension  $k = 1$ . (Compare §4.5.) We will see in §14 that it is satisfied for the complex projective space  $P^m(\mathbb{C})$ , a  $2m$ -dimensional manifold with cohomology generator in dimension  $k = 2$ . Similarly, it is satisfied for the quaternion projective  $m$ -space, a  $4m$ -dimensional manifold with

cohomology generator in dimension  $k = 4$ . (See for example [Spanier].) Finally, it is satisfied for the Cayley plane, a 16-dimensional manifold with cohomology generator  $a \in H^8(M)$ , and with Stiefel-Whitney class  $w = (1+a)^3 = 1 + a + a^2$ . (See [Borel, 1950].)

These are essentially the only examples which exist. For according to [Adams, 1960], if a space  $X$  has mod 2 cohomology generated by  $a \in H^k(X)$  with  $k \geq 1$ , and if  $a^2 \neq 0$ , then  $k$  must be either 1, 2, 4, or 8. Furthermore, if  $a^3 \neq 0$ , then by [Adem, 1952]  $k$  must be 1, 2, or 4. Thus the manifolds described above give the only possible truncated polynomial rings on one generator over  $\mathbb{Z}/2$ . (Compare the discussion of related problems on pages 47, 48.)

*Proof of 11.15.* The action of the Steenrod squares on  $H^*(M)$  is evidently given by

$$\text{Sq}(a) = a + a^2 ,$$

and hence

$$\text{Sq}(a^i) = (a + a^2)^i = a^i(1 + a)^i .$$

It follows that the Kronecker index  $\langle \text{Sq}(a^i), \mu \rangle$  is equal to the binomial coefficient  $\binom{i}{m-i}$ . Applying the formula

$$\langle \text{Sq}(a^i), \mu \rangle = \langle v \cup a^i, \mu \rangle ,$$

this implies that the coefficient of  $a^{m-i}$  in the total Wu class  $v$  must also be equal to  $\binom{i}{m-i}$ . Hence

$$v = \sum \binom{i}{m-i} a^{m-i} .$$

Substituting  $j$  for  $m-i$ , it will be more convenient to write this as  $v = \sum \binom{m-j}{j} a^j$ . Therefore

$$w = \text{Sq}(v) = \sum \binom{m-j}{j} \text{Sq}(a^j) .$$

Since we know how to compute  $Sq(a^j)$ , an explicit computation with binomial coefficients should now complete the argument. For example, if  $m = 5$ , then

$$v = \sum \binom{5-j}{j} a^j = 1 + a^2 ,$$

hence

$$w = Sq(1 + a^2) = 1 + a^2 + a^4 .$$

In general it is clear that the necessary computation, expressing  $w$  as a polynomial function of  $a$ , depends only on  $m$ , being completely independent of the dimension  $k$  of  $a$ . But this gives us a convenient short-cut. For when  $k = 1$  we already know that this computation must lead to the formula  $w = (1 + a)^{m+1}$  by Theorem 4.5. Evidently an identical computation, applied to a generator  $a$  of higher dimension, must lead to this same formula. ■

*Problem 11-A.* Prove Lemma 4.3 (that is compute the mod 2 cohomology of  $P^n$ ) by induction on  $n$ , using the Duality Theorem and the cell structure of §6.5.

*Problem 11-B. More Poincaré Duality.* For  $M$  compact, using field coefficients, show that

$$u'' : H_{n-k}(M) \rightarrow H^k(M)$$

is an isomorphism. Using the cap product operation of Appendix A, show that the inverse isomorphism is given by

$$\cap \mu : H^k(M) \rightarrow H_{n-k}(M)$$

multiplied by the sign  $(-1)^{kn}$ .

*Problem 11-C.* Let  $M = M^n$  and  $A = A^p$  be compact oriented manifolds with smooth embedding  $i : M \rightarrow A$ . Let  $k = p - n$ . Show that the Poincaré duality isomorphism



$$\cap \mu_A : H^k(A) \rightarrow H_n(A)$$

maps the cohomology class  $u'|_A$  "dual" to  $M$  to the homology class  $(-1)^{nk} i_*(\mu_M)$ . [We assume that the normal bundle  $\nu^k$  is oriented so that  $\tau_M \oplus \nu^k$  is orientation preserving isomorphic to  $\tau_A|_M$ . The proof makes use of the commutative diagram

$$\begin{array}{ccccc} H^k(A, A-M) \otimes H_p(A) & \rightarrow & H^k(A, A-M) \otimes H_p(A, A-M) & \cong & H^k(N, N-M) \otimes H_p(N, N-M) \\ \downarrow & & \downarrow & & \downarrow \\ H^k(A) \otimes H_p(A) & \longrightarrow & H_n(A) & \longleftarrow & H_n(N) \end{array} ,$$

where  $N$  is a tubular neighborhood of  $M$  in  $A$ ].

*Problem 11-D.* Prove that all Stiefel-Whitney numbers of a 3-manifold are zero.

*Problem 11-E.* Prove the following version of Wu's formula. Let

$$\overline{Sq} : H^{\Pi}(M) \rightarrow H^{\Pi}(M)$$

be the inverse of the ring automorphism  $Sq$ . Show that the dual Stiefel-Whitney classes  $\overline{w}_i(\tau_M)$  are determined by the formula

$$\langle \overline{Sq}(x), \mu \rangle = \langle \overline{w} \cup x, \mu \rangle ,$$

which holds for every cohomology class  $x$ . Show that  $\overline{w}_n = 0$ . If  $n$  is not a power of 2, show that  $\overline{w}_{n-1} = 0$ .

*Problem 11-F.* Defining Steenrod operations  $Sq^i : H_k(X) \rightarrow H_{k-i}(X)$  on mod 2 homology by the identity

$$\langle x, Sq^i(\beta) \rangle = \langle \overline{Sq}^i(x), \beta \rangle ,$$

show that

$$Sq(a \cap \beta) = Sq(a) \cap Sq(\beta) ,$$

and that

$$\text{Sq}(u''/\beta) = \text{Sq}(u'')/\text{Sq}(\beta) .$$

Prove the formulas  $\text{Sq}(\mu) = \bar{w} \cap \mu$  and  $\overline{\text{Sq}}(\mu) = v \cap \mu$ .

## §12. Obstructions

In the original work of Stiefel and Whitney, characteristic classes were defined as obstructions to the existence of certain fields of linearly independent vectors. A careful exposition from this point of view is given in Steenrod's "Theory of Fibre Bundles," sections 25.6, 35, and 38. The construction can be outlined roughly as follows.

Let  $\xi$  be an  $n$ -plane bundle with base space  $B$ . For each fiber  $F$  of  $\xi$  consider the Stiefel manifold  $V_k(F)$  consisting of all  $k$ -frames in  $F$ . Here by a  $k$ -frame we mean simply a  $k$ -tuple  $(v_1, \dots, v_k)$  of linearly independent vectors of  $F$ ; where  $1 \leq k \leq n$ . (Compare §5. Steenrod uses orthonormal  $k$ -frames, but this modification does not affect the argument). These manifolds  $V_k(F)$  can be considered as the fibers of a new fiber bundle which we will denote by  $V_k(\xi)$  and call the *associated Stiefel manifold bundle* over  $B$ . By definition, the total space of  $V_k(\xi)$  consists of all pairs  $(x, (v_1, \dots, v_k))$  where  $x$  is a point of  $B$  and  $(v_1, \dots, v_k)$  is a  $k$ -frame in the fiber  $F_x$  over  $x$ . Note that a cross-section of this Stiefel manifold bundle is nothing but a  $k$ -tuple of linearly independent cross-sections of the vector bundle  $\xi$ .

Now suppose that the base space  $B$  is a CW-complex.\* As an example, if the base space is a smooth paracompact manifold then according to J. H. C. Whitehead it possesses a smooth triangulation, and hence can certainly be given the structure of a CW-complex. (Compare [Munkres].)

---

\* Steenrod considers only the case of a finite cell complex but it is useful, and not much more difficult, to allow arbitrary CW-complexes.

Steenrod shows that the fiber  $V_k(\mathbb{F})$  is  $(n-k-1)$ -connected, so it is easy to construct a cross-section of  $V_k(\xi)$  over the  $(n-k)$ -skeleton of  $B$ . There exists a cross-section over the  $(n-k+1)$ -skeleton of  $B$  if and only if a certain well defined *primary obstruction class* in

$$H^{n-k+1}(B; \{\pi_{n-k}V_k(\mathbb{F})\})$$

is zero. Here we are using cohomology with *local coefficients*. The notation  $\{\pi_{n-k}V_k(\mathbb{F})\}$  is used to denote the system of local coefficients (= bundle of abelian groups) which associates to each point  $x$  of  $B$  the coefficient group  $\pi_{n-k}V_k(\mathbb{F}_x)$ . (In the special case  $n-k=0$ ,  $\pi_0X$  is defined to be the reduced singular group  $\tilde{H}_0(X; \mathbb{Z})$ .)

Setting  $j = n-k+1$ , we will use the notation

$$o_j(\xi) \in H^j(B; \{\pi_{j-1}V_{n-j+1}(\mathbb{F})\})$$

for this primary obstruction class. If  $j$  is even, and less than  $n$ , then Steenrod shows that the coefficient group  $\pi_{j-1}V_{n-j+1}(\mathbb{F})$  is cyclic of order 2. Hence it is canonically isomorphic to  $\mathbb{Z}/2$ . If  $j$  is odd, or  $j = n$ , the group  $\pi_{j-1}V_{n-j+1}(\mathbb{F})$  is infinite cyclic. However it is not canonically isomorphic to  $\mathbb{Z}$ . The system of local coefficients  $\{\pi_{j-1}V_{n-j+1}(\mathbb{F})\}$  is twisted in general.

In any case, there is certainly a unique non-trivial homomorphism  $h$  from  $\pi_{j-1}V_{n-j+1}(\mathbb{F})$  to  $\mathbb{Z}/2$ . Hence we can reduce the coefficients modulo 2, obtaining an induced cohomology class  $h_*o_j(\xi) \in H^j(B; \mathbb{Z}/2)$ .

**THEOREM 12.1.** *This reduction modulo 2 of the obstruction class  $o_j(\xi)$  is equal to the Stiefel-Whitney class  $w_j(\xi)$ .*

*Proof.* First consider the universal bundle  $\gamma^n$  over  $G_n = G_n(\mathbb{R}^\infty)$ . Since  $H^*(G_n; \mathbb{Z}/2)$  is a polynomial algebra on generators  $w_1(\gamma^n), \dots, w_n(\gamma^n)$ , it follows that

$$h_* o_j(\gamma^n) = f_j(w_1(\gamma^n), \dots, w_n(\gamma^n))$$

for some polynomial  $f_j$  in  $n$  variables. Since both the obstruction class and the Stiefel-Whitney classes are natural with respect to bundle mappings (see [Steenrod, §35.7]), it follows that

$$h_* o_j(\xi) = f_j(w_1(\xi), \dots, w_n(\xi))$$

for any  $n$ -plane bundle  $\xi$  over a CW-complex.

Since  $f_j(w_1, \dots, w_n)$  is a cohomology class of dimension  $j \leq n$ , the polynomial  $f_j$  can certainly be written uniquely as a sum

$$f_j(w_1, \dots, w_n) = f'(w_1, \dots, w_{j-1}) + \lambda w_j$$

where  $f' = f'_{j,n}$  is a polynomial and  $\lambda = \lambda_{j,n}$  equals 0 or 1.

To compute  $f'$ , consider the  $n$ -plane bundle  $\eta = \gamma^{j-1} \oplus \varepsilon^{n-j+1}$  over  $G_{j-1}$ , where  $\varepsilon^{n-j+1}$  is a trivial bundle. This bundle  $\eta$  admits  $n-j+1$  linearly independent cross-sections, so the obstruction class

$$o_j(\eta) \in H^j(B; \{\pi_{j-1} V_{n-j+1}(F)\})$$

must be zero. Therefore the mod 2 class

$$\begin{aligned} h_* o_j(\eta) &= f'(w_1(\eta), \dots, w_{j-1}(\eta)) + \lambda w_j(\eta) \\ &= f'(w_1(\gamma^{j-1}), \dots, w_{j-1}(\gamma^{j-1})) + 0 \end{aligned}$$

is equal to zero. Since the classes  $w_1(\gamma^{j-1}), \dots, w_{j-1}(\gamma^{j-1})$  are algebraically independent, this proves that  $f' = 0$ . Thus

$$h_* o_j(\xi) = \lambda w_j(\xi)$$

for any  $n$ -plane bundle  $\xi$ .

To prove that  $\lambda = \lambda_{j,n}$  is equal to 1, first consider the case  $j = n$ . Let  $\xi = \gamma_1^n$  be the restriction of the universal bundle  $\gamma^n$  to the Grassmann manifold  $G_n(\mathbb{R}^{n+1})$  of  $n$ -planes in  $(n+1)$ -space. Identifying  $G_n(\mathbb{R}^{n+1})$

with the real projective space  $P^n$  as in 5.1, this bundle  $\gamma_1^n$  can be described as follows. Corresponding to each pair of antipodal points  $\{u, -u\}$  on the unit sphere  $S^n$  one associates the fiber consisting of all vectors  $v$  in  $\mathbb{R}^{n+1}$  with  $u \cdot v = 0$ .

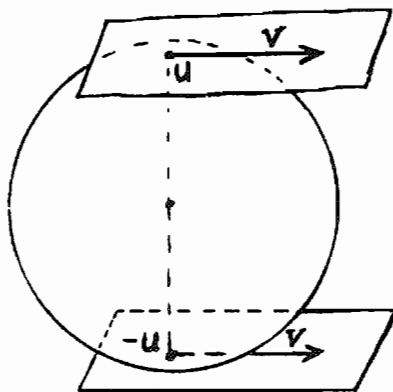

A cross-section of  $\gamma_1^n$  which is non-zero except at a single point  $\{u_0, -u_0\}$  of  $P^n$  is given by the formula  $\{u, -u\} \mapsto u_0 - (u_0 \cdot u)u$ .

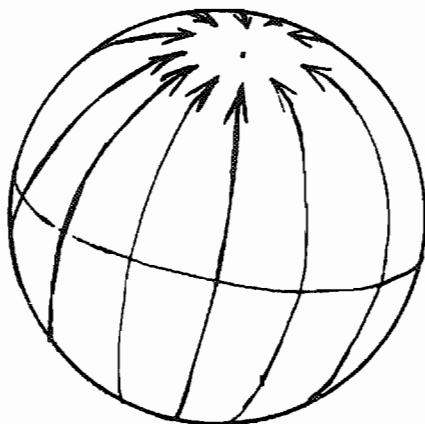

Now choosing the point  $u_0$  in the middle of the  $n$ -dimensional cell of  $P^n$  (compare §6.5), we have a cross-section of  $V_1(\gamma_1^n)$  over the  $(n-1)$ -skeleton, and the obstruction cocycle clearly assigns to the  $n$ -cell a generator of the cyclic group

$$\pi_{n-1} V_1 F = \pi_{n-1}(F-0) \cong \mathbb{Z} .$$

Thus  $h_{*0_n}(\gamma_1^n) \neq 0$ , so the coefficient  $\lambda_{n,n}$  must be equal to 1.

The proof for  $j < n$  is completely analogous. One uses the vector bundle  $\gamma_1^j \oplus \epsilon^{n-j}$  over  $G_j(\mathbb{R}^{j+1}) \cong P^j$ , together with the description of the generator of the group  $\pi_{j-1} V_{n-j+1}(\mathbb{R}^n)$  which is given in [Steenrod, §25.6]. ■

REMARK. Closely related to the obstruction point of view is a curious description of the Stiefel-Whitney classes of a manifold  $M$  which was conjectured by Stiefel and first proved by Whitney. *Choosing any smooth triangulation of  $M$ , the sum of all simplices in the first barycentric subdivision is a mod 2 cycle, representing the homology class  $w \cap \mu$  which is Poincaré dual to the total Stiefel-Whitney class of  $r_M$ .* A proof of this result has recently been published by [Halperin and Toledo].

If we are given the Stiefel-Whitney classes  $w_j(\xi)$  of an  $n$ -plane bundle, to what extent is it possible to reconstruct the obstruction classes  $o_j(\xi)$ ? If  $j = 2i$  is even and less than  $n$ , then the coefficient group  $\pi_{j-1}V_{n-j+1}(\mathbb{F})$  has order 2, so we can write

$$o_{2i}(\xi) = w_{2i}(\xi) \quad \text{for } 2i < n ,$$

without any danger of ambiguity. Furthermore, according to [Steenrod, §38.8], the class  $o_{2i+1}(\xi)$  can be expressed as the image  $\delta^* o_{2i}(\xi)$  where  $\delta^*$  is a suitably defined cohomology operation. *Thus the obstruction classes  $o_j(\xi)$  with  $j$  odd or  $j < n$  are completely determined by the Stiefel-Whitney classes of  $\xi$ .*

We will show that the highest obstruction class  $o_n(\xi)$  can be identified with the Euler class  $e(\xi)$ , provided that  $\xi$  is oriented. We will make use of two important constructions in the proof.

### The Gysin Sequence of a Vector Bundle

Let  $\xi$  be an  $n$ -plane bundle with projection map  $\pi : E \rightarrow B$ . Restricting  $\pi$  to the space  $E_0$  of non-zero vectors in  $E$ , we obtain an associated projection map  $\pi_0 : E_0 \rightarrow B$ .

THEOREM 12.2. *To any oriented  $n$ -plane bundle  $\xi$  there is associated an exact sequence of the form*

$$\dots \longrightarrow H^i(B) \xrightarrow{Ue} H^{i+n}(B) \xrightarrow{\pi_0^*} H^{i+n}(E_0) \longrightarrow H^{i+1}(B) \xrightarrow{Ue} \dots ,$$

*using integer coefficients.*

Here the symbol  $\cup e$  stands for the homomorphism  $a \mapsto a \cup e(\xi)$ .

*Proof.* Starting with the cohomology exact sequence

$$\dots \rightarrow H^j(E, E_0) \rightarrow H^j(E) \rightarrow H^j(E_0) \xrightarrow{\delta} H^{j+1}(E, E_0) \rightarrow \dots$$

of the pair  $(E, E_0)$ , use the isomorphism

$$\cup u : H^{j-n}(E) \rightarrow H^j(E, E_0)$$

of §10, to substitute the isomorphic group  $H^{j-n}(E)$  in place of  $H^j(E, E_0)$ .

Thus we obtain an exact sequence of the form

$$\dots \rightarrow H^{j-n}(E) \xrightarrow{g} H^j(E) \rightarrow H^j(E_0) \rightarrow H^{j-n+1}(E) \rightarrow \dots,$$

where

$$g(x) = (x \cup u)|E = x \cup (u|E).$$

Now substitute the isomorphic cohomology ring  $H^*(B)$  in place of  $H^*(E)$ . Since the cohomology class  $u|E$  in  $H^n(E)$  corresponds to the Euler class in  $H^n(B)$ , this yields the required exact sequence

$$\dots \longrightarrow H^{j-n}(B) \xrightarrow{\cup e} H^j(B) \longrightarrow H^j(E_0) \longrightarrow H^{j-n+1}(B) \longrightarrow \dots \blacksquare$$

Similarly, for an unoriented bundle, there is a corresponding exact sequence with mod 2 coefficients, using the Stiefel-Whitney class  $w_n(\xi)$  in place of the Euler class. (Compare the proof of 11.3.) As an example, consider the twisted line bundle  $\gamma_n^1$  over the projective space  $P^n$ . Since the space  $E_0(\gamma_n^1)$  can be identified with  $R^{n+1} - 0$ , it contains the unit sphere  $S^n$  as deformation retract. Thus we obtain an exact sequence

$$\dots \longrightarrow H^{j-1}(P^n) \xrightarrow{\cup w_1} H^j(P^n) \longrightarrow H^j(S^n) \longrightarrow H^j(P^n) \longrightarrow \dots$$

with mod 2 coefficients, where  $w_1 = w_1(\gamma_n^1)$ .



More generally consider any 2-fold covering  $\tilde{B} \rightarrow B$ . That is assume that each point of  $B$  has an open neighborhood  $U$  whose inverse image consists of two disjoint open copies of  $U$ . Then we can construct a line bundle  $\xi$  over  $B$  whose total space  $E$  is obtained from  $\tilde{B} \times \mathbb{R}$  by identifying each pair  $(x, t)$  with  $(x', -t)$ , where  $x$  and  $x'$  are the two distinct points of  $\tilde{B}$  lying over one point of  $B$ . Evidently the open subset  $E_0$  contains  $\tilde{B}$  as deformation retract. Thus we have proved the following.

COROLLARY 12.3. *To any 2-fold covering  $\tilde{B} \rightarrow B$  there is associated an exact sequence of the form*

$$\dots \longrightarrow H^{j-1}(B) \xrightarrow{Uw_1} H^j(B) \longrightarrow H^j(\tilde{B}) \longrightarrow H^j(B) \longrightarrow \dots$$

*with mod 2 coefficients, where  $w_1 = w_1(\xi)$ .*

### The Oriented Universal Bundle

Let  $\tilde{G}_n(\mathbb{R}^{n+k})$  denote the Grassmann manifold consisting of all oriented  $n$ -planes in  $(n+k)$ -space. Just as in §5, this can be topologized as a quotient space of the Stiefel manifold  $V_n(\mathbb{R}^{n+k})$ . Clearly  $\tilde{G}_n(\mathbb{R}^{n+k})$  is a 2-fold covering space of the unoriented Grassmann manifold  $G_n(\mathbb{R}^{n+k})$ . It is easy to check that  $\tilde{G}_n(\mathbb{R}^{n+k})$  is a compact CW-complex of dimension  $nk$ . Passing to the direct limit as  $k \rightarrow \infty$ , we obtain an infinite CW-complex  $\tilde{G}_n = \tilde{G}_n(\mathbb{R}^\infty)$ . (The notations  $BSO(n)$ , respectively  $BO(n)$ , are often used for these spaces  $\tilde{G}_n$  and  $G_n$ .)

The universal bundle  $\gamma^n$  over  $G_n$  lifts to an oriented  $n$ -plane bundle over  $\tilde{G}_n$ . We will denote this *oriented universal bundle* by the symbol  $\tilde{\gamma}^n$ . It is clear that for any oriented  $n$ -plane bundle  $\xi$ , each bundle map  $\xi \rightarrow \gamma^n$  lifts uniquely to an orientation preserving bundle map  $\xi \rightarrow \tilde{\gamma}^n$ .

The mod 2 cohomology of  $\tilde{G}_n$  can be computed as follows. (Compare §7.)

**THEOREM 12.4.** *The cohomology  $H^*(\tilde{G}_n; \mathbb{Z}/2)$  is a polynomial algebra over  $\mathbb{Z}/2$ , freely generated by the Stiefel-Whitney classes  $w_2(\tilde{\gamma}^n), \dots, w_n(\tilde{\gamma}^n)$ .*

In particular the group  $H^1(\tilde{G}_n; \mathbb{Z}/2)$  is zero. It follows that  $w_1(\tilde{\gamma}^n) = 0$ , and hence that  $w_1(\xi) = 0$  for any orientable vector bundle  $\xi$  over a paracompact base space. (Compare Problem 12-A.)

*Proof of 12.4.* By 12.3 there is an exact sequence

$$\dots \longrightarrow H^{j-1}(G_n) \xrightarrow{Uc} H^j(G_n) \xrightarrow{p^*} H^j(\tilde{G}_n) \longrightarrow H^j(G_n) \longrightarrow \dots,$$

where  $c$  is the first Stiefel-Whitney class of the line bundle associated with the 2-fold covering, and where  $p: \tilde{G}_n \rightarrow G_n$  is the natural map. This class  $c$  cannot be zero. For otherwise the sequence

$$0 \longrightarrow H^0(G_n) \longrightarrow H^0(\tilde{G}_n) \longrightarrow H^0(G_n) \xrightarrow{Uc} \dots$$

would imply that  $\tilde{G}_n$  had two components, contradicting the evident fact that any oriented  $n$ -plane in  $\mathbb{R}^\infty$  can be deformed continuously to any other oriented  $n$ -plane. Thus  $c = w_1(\gamma^n)$ , using §7.1, and a straightforward argument completes the proof. ■

### The Euler Class as an Obstruction

We have now assembled the preliminary constructions which we will need in order to study the top obstruction class

$$o_n(\xi) \in H^n(B; \{\pi_{n-1} V_1(F)\})$$

for an oriented  $n$ -plane bundle  $\xi$ . Using the orientations of the fibers  $F$ , it is clear that each coefficient group

$$\pi_{n-1} V_1(F) = \pi_{n-1}(F-0) \cong H_{n-1}(F-0; \mathbb{Z}) \cong H_n(F, F-0; \mathbb{Z})$$

is canonically isomorphic to  $\mathbb{Z}$ . Hence the following statement makes sense.

**THEOREM 12.5.** *If  $\xi$  is an oriented  $n$ -plane bundle over a CW-complex, then  $\circ_n(\xi)$  is equal to the Euler class  $e(\xi)$ .*

*Proof.* Using the projection map  $\pi_0: E_0 \rightarrow B$ , let us form the induced bundle  $\pi_0^*\xi$  over  $E_0$ . Clearly this induced bundle has a nowhere zero cross-section, hence

$$\pi_0^* \circ_n(\xi) = \circ_n(\pi_0^*\xi) = 0 .$$

Using the Gysin exact sequence

$$H^0(B) \xrightarrow{\cup e} H^n(B) \xrightarrow{\pi_0^*} H^n(E_0)$$

with integer coefficients, it follows that

$$\circ_n(\xi) = \lambda \cup e(\xi)$$

for some  $\lambda \in H^0(B)$ . In particular this argument applies to the universal bundle  $\tilde{\gamma}^n$  over  $\tilde{G}_n$ . Using the Gysin sequence

$$H^0(\tilde{G}_n) \xrightarrow{\cup e} H^n(\tilde{G}_n) \xrightarrow{\pi_0^*} H^n(E_0(\tilde{\gamma}^n)) ,$$

it follows that

$$\circ_n(\tilde{\gamma}^n) = \lambda_n e(\tilde{\gamma}^n)$$

for some integer  $\lambda_n$ . Therefore, by naturality,

$$\circ_n(\xi) = \lambda_n e(\xi)$$

for every oriented  $n$ -plane bundle  $\xi$  over a CW-complex.

Now reduce both sides of this equation modulo 2, obtaining

$$w_n(\tilde{\gamma}^n) = \lambda_n w_n(\tilde{\gamma}^n)$$

by 12.1 and 9.5. Since  $w_n(\tilde{\gamma}^n) \neq 0$  by 12.4, this proves that the integer  $\lambda_n$  is odd.

If the dimension  $n$  is odd, then the Euler class itself has order 2 by 9.4, so we have proved that  $\nu_n(\xi) = e(\xi)$ .

If the dimension  $n$  is even, we must prove that  $\lambda_n = +1$ . Let  $\tau$  be the tangent bundle of the  $n$ -sphere with  $n$  even. Then the Kronecker index  $\langle e(\tau), \mu \rangle$  is equal to the Euler characteristic  $\chi(S^n) = +2$  by 11.12. The analogous formula

$$\langle \nu_n(\tau), \mu \rangle = +2$$

is true by [Steenrod, §39.6], or can be verified directly by inspecting the vector field on  $S^n$  which is portrayed on p. 142. Thus the coefficient  $\lambda_n$  must be equal to  $+1$ . ■

*Problem 12-A.* Prove that a vector bundle  $\xi$  over a CW-complex is orientable if and only if  $w_1(\xi) = 0$ .

*Problem 12-B.* Using the Wu formula 11.14 and the fact that  $\pi_2 V_2(\mathbb{R}^3) \cong \pi_2 SO(3) = 0$  [Steenrod, p. 116], prove Stiefel's theorem that every compact orientable 3-manifold is parallelizable.

*Problem 12-C.* Use Corollary 12.3 to give another proof that  $H^*(\mathbb{P}^n; \mathbb{Z}/2)$  is as described in §4.3.

*Problem 12-D.* Show that  $\tilde{G}_n(\mathbb{R}^{n+k})$  is a smooth, compact, orientable manifold of dimension  $nk$ . Show that the correspondence which maps a plane with oriented basis  $b_1, \dots, b_n$  to  $b_1 \wedge \dots \wedge b_n / |b_1 \wedge \dots \wedge b_n|$  embeds  $\tilde{G}_n(\mathbb{R}^{n+k})$  smoothly in the exterior power  $\Lambda^n \mathbb{R}^{n+k}$ .

### §13. Complex Vector Bundles and Complex Manifolds

It is often useful to consider vector bundles in which each fiber is a vector space over the complex numbers. Let  $B$  be a topological space.

**DEFINITION.** A *complex vector bundle*  $\omega$  of complex dimension  $n$  over  $B$  (or briefly a *complex  $n$ -plane bundle*) consists of a topological space  $E$  and projection map  $\pi: E \rightarrow B$ , together with the structure of a complex vector space in each fiber  $\pi^{-1}(b)$ , subject to the following:

*Local triviality requirement 13.1.* Each point of  $B$  must possess a neighborhood  $U$  so that the inverse image  $\pi^{-1}(U)$  is homeomorphic to  $U \times \mathbb{C}^n$  under a homeomorphism which maps each fiber  $\pi^{-1}(b)$  complex linearly onto  $b \times \mathbb{C}^n$ .

Here  $\mathbb{C}^n$  stands for the coordinate space of  $n$ -tuples of complex numbers, and  $b \times \mathbb{C}^n$  is made into a complex vector space by ignoring the  $b$  coordinate.

Just as in §3, we can form new complex vector bundles out of old ones by forming Whitney sums or tensor products (over the complex numbers  $\mathbb{C}$ ) or by forming induced vector bundles.

One method of constructing a complex  $n$ -plane bundle is to start with a real  $2n$ -plane bundle, attempting to give each fiber the additional structure of a complex vector space.

**DEFINITION.** A *complex structure* on a real  $2n$ -plane bundle  $\xi$  is a continuous mapping

$$J: E(\xi) \rightarrow E(\xi)$$

from the total space to itself which maps each fiber  $\mathbb{R}$ -linearly into itself, and which satisfies the identity  $J(J(v)) = -v$  for every vector  $v$  in  $E(\xi)$ .

Given such a complex structure, we can make each fiber  $F_b(\xi)$  into a complex vector space by setting

$$(x + iy)v = xv + J(yv)$$

for every complex number  $x + iy$ . The local triviality condition 13.1 is easily verified, so that  $\xi$  becomes a complex vector bundle.

Conversely of course, given any complex  $n$ -plane bundle  $\omega$  we can simply forget about the complex structure and think of each fiber as a real vector space of dimension  $2n$ . Thus we obtain the *underlying real  $2n$ -plane bundle*  $\omega_{\mathbb{R}}$ . Note that this real bundle  $\omega_{\mathbb{R}}$  and the original complex bundle  $\omega$  both have the same total space, base space, and the same projection map.

Perhaps the most important example of a complex vector bundle is provided by the tangent bundle of a "complex manifold." We will look at a special case first.

**EXAMPLE 13.2.** Let  $U$  be an open subset of the coordinate space  $\mathbb{C}^n$ . Then the tangent bundle  $\tau_U$ , with total space  $DU = U \times \mathbb{C}^n$ , has a canonical complex structure  $J_0$  defined by

$$J_0(u, v) = (u, iv)$$

for every  $u \in U$  and  $v \in \mathbb{C}^n$ .

Now consider a smooth mapping  $f: U \rightarrow U'$ , where  $U' \subset \mathbb{C}^p$  is also an open subset of a complex coordinate space. We can ask whether the  $\mathbb{R}$ -linear mapping  $Df_u: DU_u \rightarrow DU'_{f(u)}$  is actually complex linear for all  $u$ , so that

$$(Df) \circ J_0 = J_0 \circ Df .$$

If the derivative is complex linear, one says that  $f$  satisfies the *Cauchy-Riemann equations*, or that  $f$  is *holomorphic* or *complex analytic*. A

standard theorem asserts that  $f$  can then be expressed locally as the sum of a convergent complex power series. (Compare [Hörmander] or [Gunning-Rossi].)

Let  $M$  be a smooth manifold of dimension  $2n$ . A complex structure on the tangent bundle of  $M$  is sometimes called an “almost complex structure” on  $M$ .

**DEFINITION 13.3.** A complex structure on the manifold  $M$  is a complex structure  $J$  on the tangent bundle  $\tau_M$  which satisfies the following extremely stringent condition: *Every point of  $M$  must possess an open neighborhood which is diffeomorphic to an open subset of  $\mathbb{C}^n$  under a diffeomorphism  $h$  whose derivative is everywhere complex linear:*

$$dh \circ J = J_0 \circ dh.$$

The pair  $(M, J)$  is then called a *complex manifold* of complex dimension  $n$ . In practice, by abuse of notation, we will usually use the single symbol  $M$  for a complex manifold.

**DEFINITION.** A smooth mapping  $f: M \rightarrow N$  between complex manifolds is *holomorphic* if  $Df$  is complex linear,  $(Df) \circ J = J \circ Df$ .

**REMARKS.** A fundamental theorem of [Newlander and Nirenberg] asserts that a smooth almost complex structure  $J$  is actually a complex structure if and only if it satisfies a certain system of quadratic first order partial differential equations. In terms of the bracket product of vector fields, these equations can be written as

$$[Jv, Jw] = J[v, Jw] + J[Jv, w] + [v, w],$$

where  $v$  and  $w$  are arbitrary smooth vector fields on  $M$ .

The most classical (and often the most convenient) procedure for assigning a complex structure to a smooth manifold is the following. One gives a collection of diffeomorphisms  $h_\alpha: U_\alpha \rightarrow V_\alpha$  where the  $U_\alpha$  are

open subsets of  $\mathbb{C}^n$  and the  $V_\alpha$  are open sets covering the manifold. It is only necessary to verify that each composition

$$h_\beta^{-1} \circ h_\alpha : h_\alpha^{-1}(V_\alpha \cap V_\beta) \rightarrow h_\beta^{-1}(V_\alpha \cap V_\beta)$$

is holomorphic.

In conclusion, here are some exercises for the reader.

*Problem 13-A.* Show that a complex structure  $J : E(\xi) \rightarrow E(\xi)$  on a real vector bundle automatically satisfies the complex local triviality condition 13.1.

*Problem 13-B.* If  $M$  is a complex manifold, show that  $DM$  is a complex manifold. Similarly, if  $f : M \rightarrow N$  is holomorphic, show that  $Df : DM \rightarrow DN$  is holomorphic.

*Problem 13-C.* If  $M$  is a compact complex manifold, show that every holomorphic map  $f : M \rightarrow \mathbb{C}$  is constant.

*Problem 13-D.* Show that the projective space  $P^n(\mathbb{C})$ , consisting of all complex lines through the origin in  $\mathbb{C}^{n+1}$ , can be given the structure of a complex manifold. (Note that  $P^1(\mathbb{C})$  can be identified with the complex line  $\mathbb{C}$  together with a single point at infinity.) More generally show that the space  $G_k(\mathbb{C}^n)$  of complex  $k$ -planes through the origin in  $\mathbb{C}^n$  is a complex manifold of complex dimension  $k(n-k)$ .

*Problem 13-E.* Let  $\gamma_n^1$  denote the canonical complex line bundle over  $P^n(\mathbb{C})$ . Thus the total space  $E(\gamma_n^1)$  consists of all pairs  $(L, v)$  where  $L$  is a complex line through the origin in  $\mathbb{C}^{n+1}$  and  $v \in L$ . Show that  $\gamma_n^1$  does not possess any holomorphic cross-section, other than the zero cross-section. Show, however, that the dual bundle  $\text{Hom}_{\mathbb{C}}(\gamma_n^1, \mathbb{C})$  possesses at least  $n+1$  holomorphic cross-sections which are linearly independent over  $\mathbb{C}$ .



*Problem 13-F.* If  $M$  is a complex  $n$ -manifold, then the real vector bundle  $\text{Hom}_{\mathbb{R}}(\tau_M, \mathbb{R})$  of tangent co-vectors does not possess any natural complex structure. Show, however, that its “complexification”

$$\text{Hom}_{\mathbb{R}}(\tau_M, \mathbb{R}) \otimes_{\mathbb{R}} \mathbb{C} \cong \text{Hom}_{\mathbb{R}}(\tau_M, \mathbb{C})$$

is a complex  $2n$ -plane bundle which splits canonically as a Whitney sum

$$\text{Hom}_{\mathbb{C}}(\tau_M, \mathbb{C}) \oplus \overline{\text{Hom}_{\mathbb{C}}(\tau_M, \mathbb{C})} .$$

Here  $\overline{\text{Hom}_{\mathbb{C}}(DM_x, \mathbb{C})}$  denotes the complex vector space of conjugate linear mappings,  $h(\lambda v) = \bar{\lambda}h(v)$ . If  $U \subset \mathbb{C}^n$  is an open set with coordinate functions  $z_1, \dots, z_n: U \rightarrow \mathbb{C}$ , show that the total differentials  $dz_1(u), \dots, dz_n(u)$  form a basis for  $\text{Hom}_{\mathbb{C}}(DU_u, \mathbb{C})$ , and that  $d\bar{z}_1(u), \dots, d\bar{z}_n(u)$  form a basis for  $\overline{\text{Hom}_{\mathbb{C}}(DU_u, \mathbb{C})}$ .

If  $f$  is a smooth (but not necessarily holomorphic) complex valued function on  $U$ , it follows that  $df$  can be written uniquely as a linear combination of  $dz_1, \dots, dz_n, d\bar{z}_1, \dots, d\bar{z}_n$ , with coefficients which are also smooth complex valued functions on  $U$ . These coefficients are customarily denoted by  $\partial f/\partial z_1, \dots, \partial f/\partial z_n, \partial f/\partial \bar{z}_1, \dots, \partial f/\partial \bar{z}_n$  respectively. Thus the total differential  $df$  can be expressed uniquely as a sum  $\partial f + \bar{\partial}f$  where  $\partial f = \sum (\partial f/\partial z_j)dz_j$  is a section of  $\text{Hom}_{\mathbb{C}}(\tau_M, \mathbb{C})$  and  $\bar{\partial}f = \sum (\partial f/\partial \bar{z}_j)d\bar{z}_j$  is a section of  $\overline{\text{Hom}_{\mathbb{C}}(\tau_M, \mathbb{C})}$ . Setting  $z_j = x_j + iy_j$ , show that  $\partial f/\partial \bar{z}_j$  is equal to  $\frac{1}{2}(\partial f/\partial x_j + i \partial f/\partial y_j)$ . Show that the Cauchy-Riemann equations for  $f$  can be written as  $\partial f/\partial \bar{z}_j = 0$ , or briefly  $\bar{\partial}f = 0$ .

*Problem 13-G.* Show that the complex vector space spanned by the differential operators  $\partial/\partial z_1, \dots, \partial/\partial z_n$  at  $z$  is canonically isomorphic to the tangent space  $DU_z$ .

## §14. Chern Classes

We will first prove the following statement.

**LEMMA 14.1.** *If  $\omega$  is a complex vector bundle, then the underlying real vector bundle  $\omega_{\mathbb{R}}$  has a canonical preferred orientation.*

Applying this lemma to the special case of a tangent bundle, it follows that *any complex manifold has a canonical preferred orientation*. For we have seen on p. 122 that every orientation for the tangent bundle of a manifold gives rise to a unique orientation of the manifold.

*Proof of 14.1.* Let  $V$  be any finite dimensional complex vector space. Choosing a basis  $a_1, \dots, a_n$  for  $V$  over  $\mathbb{C}$ , note that the vectors  $a_1, ia_1, a_2, ia_2, \dots, a_n, ia_n$  form a real basis for the underlying real vector space  $V_{\mathbb{R}}$ . This ordered basis determines the required orientation for  $V_{\mathbb{R}}$ . To show that this orientation does not depend on the choice of complex basis, we need only note that the linear group  $GL(n, \mathbb{C})$  is connected. Hence we can pass from any given complex basis to any other complex basis by a continuous deformation, which cannot alter the induced orientation.

Now if  $\omega$  is a complex vector bundle, then applying this construction to every fiber of  $\omega$ , we obtain the required orientation for  $\omega_{\mathbb{R}}$ . ■

As an application of 14.1, for any complex  $n$ -plane bundle  $\omega$  over the base space  $B$ , note that the Euler class

$$e(\omega_{\mathbb{R}}) \in H^{2n}(B; \mathbb{Z})$$

is well defined. If  $\omega'$  is a complex  $m$ -plane bundle over the same base space  $B$ , note that

$$e((\omega \oplus \omega')_{\mathbb{R}}) = e(\omega_{\mathbb{R}})e(\omega'_{\mathbb{R}}) .$$

For if  $a_1, \dots, a_n$  is a basis for a fiber  $F$  of  $\omega$ , and  $b_1, \dots, b_m$  is a basis for the corresponding fiber  $F'$  of  $\omega'$ , then the preferred orientation  $a_1, ia_1, \dots, a_n, ia_n$  for  $F_{\mathbb{R}}$  followed by the preferred orientation  $b_1, ib_1, \dots, b_m, ib_m$  for  $F'_{\mathbb{R}}$  yields the preferred orientation  $a_1, ia_1, \dots, ia_n, b_1, ib_1, \dots, ib_m$  for  $(F \oplus F')_{\mathbb{R}}$ . Thus  $\omega_{\mathbb{R}} \oplus \omega'_{\mathbb{R}}$  is isomorphic as an oriented bundle to  $(\omega \oplus \omega')_{\mathbb{R}}$ , and the conclusion follows.

### Hermitian Metrics

Just as Euclidean metrics play an important role in the study of real vector bundles, the analogous Hermitian metrics play an important role for complex vector bundles. By definition, a *Hermitian metric* on a complex vector bundle  $\omega$  is a Euclidean metric

$$v \mapsto |v|^2 \geq 0$$

on the underlying real vector bundle (see p. 21), which satisfies the identity

$$|iv| = |v| .$$

Given such a Hermitian metric it is not difficult to show that there is one and only one complex valued inner product

$$\begin{aligned} \langle v, w \rangle &= \frac{1}{2} (|v+w|^2 - |v|^2 - |w|^2) \\ &\quad + \frac{1}{2} i(|v+iw|^2 - |v|^2 - |iw|^2) , \end{aligned}$$

defined for  $v$  and  $w$  in the same fiber of  $\omega$ , which

- (1) is complex linear as a function of  $v$  for fixed  $w$ ,
- (2) is conjugate linear as a function of  $w$  for fixed  $v$  (that is  $\langle v, \lambda w \rangle = \bar{\lambda} \langle v, w \rangle$ ), and
- (3) satisfies  $\langle v, v \rangle = |v|^2$ .

The two vectors  $v$  and  $w$  are said to be *orthogonal* if this complex inner product  $\langle v, w \rangle$  is zero. The Hermitian identity

$$\langle w, v \rangle = \overline{\langle v, w \rangle}$$

is easily verified, hence  $v$  is orthogonal to  $w$  if and only if  $w$  is orthogonal to  $v$ .

If the base space  $B$  is paracompact, then every complex vector bundle over  $B$  admits a Hermitian metric. (Compare Problem 2-C.)

### Construction of Chern Classes

We will now give an inductive definition of characteristic classes for a complex  $n$ -plane bundle  $\omega$ . It is first necessary to construct a canonical  $(n-1)$ -plane bundle  $\omega_0$  over the deleted total space  $E_0$ . (As in the real case,  $E_0 = E_0(\omega)$  denotes the set of all non-zero vectors in the total space  $E(\omega) = E(\omega_{\mathbf{R}})$ .) A point in  $E_0$  is specified by a fiber  $F$  of  $\omega$  together with a non-zero vector  $v$  in that fiber. First suppose that a Hermitian metric has been specified on  $\omega$ . Then the fiber of  $\omega_0$  over  $v$  is by definition, the orthogonal complement of  $v$  in the vector space  $F$ . This is a complex vector space of dimension  $n-1$ , and these vector spaces clearly can be considered as the fibers of a new vector bundle  $\omega_0$  over  $E_0$ .

Alternatively, without using a Hermitian metric, the fiber of  $\omega_0$  over  $v$  can be defined as the quotient vector space  $F/(\mathbb{C}v)$  where  $\mathbb{C}v$  is the 1-dimensional subspace spanned by the vector  $v \neq 0$ . In the presence of a Hermitian metric, it is of course clear that this quotient space is canonically isomorphic to the orthogonal complement of  $v$  in  $F$ .

Recall (p. 143) that any real oriented  $2n$ -plane bundle possesses an exact *Gysin sequence*

$$\dots \longrightarrow H^{i-2n}(B) \xrightarrow{\cup e} H^i(B) \xrightarrow{\pi_0^*} H^i(E_0) \longrightarrow H^{i-2n+1}(B) \longrightarrow \dots$$

with integer coefficients. For  $i < 2n-1$  the groups  $H^{i-2n}(B)$  and  $H^{i-2n+1}(B)$  are zero, so it follows that  $\pi_0^*: H^i(B) \rightarrow H^i(E_0)$  is an isomorphism.

DEFINITION. The Chern classes  $c_i(\omega) \in H^{2i}(B; \mathbb{Z})$  are defined as follows, by induction on the complex dimension  $n$  of  $\omega$ . The top Chern class  $c_n(\omega)$  is equal to the Euler class  $e(\omega_{\mathbb{R}})$ . For  $i < n$  we set

$$c_i(\omega) = \pi_0^{*-1} c_i(\omega_0) .$$

This expression makes sense since  $\pi_0^*: H^{2i}(B) \rightarrow H^{2i}(E_0)$  is an isomorphism for  $i < n$ . Finally, for  $i > n$  the class  $c_i(\omega)$  is defined to be zero.

The formal sum  $c(\omega) = 1 + c_1(\omega) + \dots + c_n(\omega)$  in the ring  $H^{\mathbb{N}}(B; \mathbb{Z})$  is called the total Chern class of  $\omega$ . Clearly  $c(\omega)$  is a unit, so that the inverse

$$c(\omega)^{-1} = 1 - c_1(\omega) + (c_1(\omega)^2 - c_2(\omega)) + \dots$$

is well defined.

LEMMA 14.2 (Naturality). If  $f: B \rightarrow B'$  is covered by a bundle map from the complex  $n$ -plane bundle  $\omega$  over  $B$  to the complex  $n$ -plane bundle  $\omega'$  over  $B'$ , then  $c(\omega) = f^* c(\omega')$ .

Proof by induction on  $n$ . The top Chern class is natural,  $c_n(\omega) = f^* c_n(\omega')$ , since Euler classes are natural (§9.2). To prove the corresponding statement for lower Chern classes, first note that the bundle map  $\omega \rightarrow \omega'$  gives rise to a map

$$f_0 : E_0(\omega) \rightarrow E_0(\omega')$$

which clearly is covered by a bundle map  $\omega_0 \rightarrow \omega'_0$  of  $(n-1)$ -plane bundles. Hence  $c_i(\omega_0) = f_0^* c_i(\omega'_0)$  by the induction hypothesis. Using the commutative diagram

$$\begin{array}{ccc}
 E_0(\omega) & \xrightarrow{f_0} & E_0(\omega') \\
 \downarrow \pi_0 & & \downarrow \pi'_0 \\
 B & \xrightarrow{f} & B'
 \end{array}$$

and the identities  $c_i(\omega_0) = \pi_0^* c_i(\omega)$  and  $c_i(\omega'_0) = \pi_0'^* c_i(\omega')$  where  $\pi_0^*$  is an isomorphism for  $i < n$ , it follows that  $c_i(\omega) = f^* c_i(\omega')$  as required. ■

LEMMA 14.3. *If  $\varepsilon^k$  is the trivial complex  $k$ -plane bundle over  $B = B(\omega)$ , then  $c(\omega \oplus \varepsilon^k) = c(\omega)$ .*

*Proof.* It is sufficient to consider the special case  $k = 1$ , since the general case then follows by induction. Let  $\phi = \omega \oplus \varepsilon^1$ . Since the  $(n+1)$ -plane bundle  $\phi$  has a non-zero cross-section, it follows by 9.7 that the top Chern class  $c_{n+1}(\phi) = e(\phi_{\mathbb{R}})$  is zero, and hence equal to  $c_{n+1}(\omega)$ . Let  $s: B \rightarrow E_0(\omega \oplus \varepsilon^1)$  be the obvious cross-section. Clearly  $s$  is covered by a bundle map  $\omega \rightarrow \phi_0$ , hence

$$s^* c_i(\phi_0) = c_i(\omega)$$

by 14.2. Substituting  $\pi_0^* c_i(\phi)$  for  $c_i(\phi_0)$ , and using the formula  $s^* \circ \pi_0^* =$  identity, it follows that  $c_i(\phi) = c_i(\omega)$  as required. ■

### Complex Grassmann Manifolds

Still continuing our complex analogue of real vector bundle theory, we define the *complex Grassmann manifold*  $G_n(\mathbb{C}^{n+k})$  to be the set of all complex  $n$ -planes through the origin in the complex vector space  $\mathbb{C}^{n+k}$ . Just as in the real case, this set has a natural structure as smooth manifold. In fact  $G_n(\mathbb{C}^{n+k})$  has a natural structure as complex analytic manifold of complex dimension  $nk$ . Furthermore there is a canonical complex  $n$ -plane bundle which we denote by  $\gamma^n = \gamma^n(\mathbb{C}^{n+k})$  over  $G_n(\mathbb{C}^{n+k})$ . By definition, the total space of  $\gamma^n$  consists of all pairs  $(X, v)$  where  $X$  is a complex  $n$ -plane through the origin in  $\mathbb{C}^{n+k}$  and  $v$  is a vector in  $X$ .

As an example, let us study the special case  $n = 1$ . The Grassmann manifold  $G_1(\mathbb{C}^{k+1})$  is also known as the *complex projective space*  $P^k(\mathbb{C})$ . We will investigate the cohomology ring  $H^*(P^k(\mathbb{C}); \mathbb{Z})$ . (Compare Problem 12-C.)

Applying the Gysin sequence to the canonical line bundle  $\gamma^1 = \gamma^1(\mathbb{C}^{k+1})$  over  $\mathbb{P}^k(\mathbb{C})$ , and using the fact that  $c_1(\gamma^1) = e(\gamma^1_{\mathbb{R}})$ , we have

$$\dots \longrightarrow H^{i+1}(E_0) \longrightarrow H^i(\mathbb{P}^k(\mathbb{C})) \xrightarrow{\cup c_1} H^{i+2}(\mathbb{P}^k(\mathbb{C})) \xrightarrow{\pi_0^*} H^{i+2}(E_0) \longrightarrow \dots,$$

using integer coefficients. The space  $E_0 = E_0(\gamma^1(\mathbb{C}^{k+1}))$  is the set of all pairs

(line through the origin in  $\mathbb{C}^{k+1}$ , non-zero vector in that line) .

This can be identified with  $\mathbb{C}^{k+1} - 0$ , and hence has the same homotopy type as the unit sphere  $S^{2k+1}$ . Thus our Gysin sequence reduces to

$$0 \longrightarrow H^i(\mathbb{P}^k(\mathbb{C})) \xrightarrow{\cup c_1} H^{i+2}(\mathbb{P}^k(\mathbb{C})) \longrightarrow 0$$

for  $0 \leq i \leq 2k-2$ . Hence

$$H^0(\mathbb{P}^k(\mathbb{C})) \cong H^2(\mathbb{P}^k(\mathbb{C})) \cong \dots \cong H^{2k}(\mathbb{P}^k(\mathbb{C})) .$$

Since  $\mathbb{P}^k(\mathbb{C})$  is clearly connected, it follows that each  $H^{2i}(\mathbb{P}^k(\mathbb{C}))$  is infinite cyclic generated by  $c_1(\gamma^1)^i$  for  $i \leq k$ . Similarly

$$H^1(\mathbb{P}^k(\mathbb{C})) \cong H^3(\mathbb{P}^k(\mathbb{C})) \cong \dots \cong H^{2k-1}(\mathbb{P}^k(\mathbb{C})) ,$$

and using the portion

$$\dots \rightarrow H^{-1}(\mathbb{P}^k(\mathbb{C})) \rightarrow H^1(\mathbb{P}^k(\mathbb{C})) \rightarrow H^1(E_0) \rightarrow \dots$$

of the Gysin sequence, we see that these odd dimensional groups are all zero. That is:

**THEOREM 14.4.** *The cohomology ring  $H^*(\mathbb{P}^k(\mathbb{C}); \mathbb{Z})$  is a truncated polynomial ring terminating in dimension  $2k$ , and generated by the Chern class  $c_1(\gamma^1(\mathbb{C}^{k+1}))$ .*

Now let us let  $k$  tend to infinity. The canonical  $n$ -plane bundle  $\gamma^n(\mathbb{C}^\infty)$  over  $G_n(\mathbb{C}^\infty)$  will be denoted briefly by  $\gamma^n$ . Using 14.4, it follows that  $H^*(G_1(\mathbb{C}^\infty))$  is the polynomial ring generated by  $c_1(\gamma^1)$ . More generally we will show the following.

**THEOREM 14.5.** *The cohomology ring  $H^*(G_n(\mathbb{C}^\infty); \mathbb{Z})$  is the polynomial ring over  $\mathbb{Z}$  generated by the Chern classes  $c_1(\gamma^n), \dots, c_n(\gamma^n)$ . There are no polynomial relations between these  $n$  generators.*

*Proof by induction on  $n$ .* We may assume that  $n \geq 2$ , since the Theorem has already been established for  $n = 1$ . Consider the Gysin sequence

$$\dots \longrightarrow H^i(G_n) \xrightarrow{\cup c_n} H^{i+2n}(G_n) \xrightarrow{\pi_0^*} H^{i+2n}(E_0) \longrightarrow H^{i+1}(G_n) \longrightarrow \dots$$

associated with the bundle  $\gamma^n$ , using integer coefficients.

We will first show that the cohomology ring  $H^*(E_0)$  can be identified with  $H^*(G_{n-1})$ . In fact a canonical map  $f: E_0 \rightarrow G_{n-1}$  is constructed as follows. By definition, a point  $(X, v)$  in  $E_0$  consists of an  $n$ -plane  $X$  in  $\mathbb{C}^\infty$  together with a non-zero vector  $v$  in  $X$ . Let  $f(X, v) = X \cap v^\perp$  be the orthogonal complement of  $v$  in  $X$ , using the standard Hermitian metric

$$\langle (v_1, v_2, \dots), (w_1, w_2, \dots) \rangle = \sum v_j \bar{w}_j$$

on  $\mathbb{C}^\infty$ . Then  $f(X, v)$  is a well defined  $(n-1)$ -plane in  $\mathbb{C}^\infty$ .

In order to show that  $f$  induces cohomology isomorphisms, it is convenient to pass to the sub-bundle  $\gamma^n(\mathbb{C}^N) \subset \gamma^n$ , consisting of complex  $n$ -planes in  $N$ -space where  $N$  is large but finite. Let  $f_N: E_0(\gamma^n(\mathbb{C}^N)) \rightarrow G_{n-1}(\mathbb{C}^N)$  be the corresponding restriction of  $f$ . For any  $(n-1)$ -plane  $Y$  in  $G_{n-1}(\mathbb{C}^N)$  it is evident that the inverse image

$$f_N^{-1}(Y) \subset E_0(\gamma^n(\mathbb{C}^N))$$



consists of all pairs  $(X, v)$  where  $v \in \mathbb{C}^N$  is a non-zero vector perpendicular to  $Y$ , and where  $X = Y + \mathbb{C}v$  is determined by  $v$  and  $Y$ . Thus  $f_N$  can be identified with the projection map

$$E_0(\omega^{N-n+1}) \rightarrow G_{n-1}(\mathbb{C}^N) ,$$

where  $\omega^{N-n+1}$  is the complex vector bundle whose fiber, over  $Y \in G_{n-1}(\mathbb{C}^N)$ , is the orthogonal complement of  $Y$  in  $\mathbb{C}^N$ .

Using the Gysin sequence of this new vector bundle, it follows that  $f_N$  induces cohomology isomorphisms in dimensions  $\leq 2(N-n)$ . Therefore, taking the direct limit as  $N$  tends to infinity,  $f$  induces cohomology isomorphisms in all dimensions.

Thus we can insert  $G_{n-1}$  in place of  $E_0$  in the Gysin sequence, obtaining a new exact sequence of the form

$$\dots \longrightarrow H^i(G_n) \longrightarrow H^{i+2n}(G_n) \xrightarrow{\lambda} H^{i+2n}(G_{n-1}) \longrightarrow H^{i+1}(G_n) \longrightarrow \dots$$

with  $\lambda = f^{*-1}\pi_0^*$ .

We must show that this homomorphism  $\lambda = f^{*-1}\pi_0^*$  maps the Chern class  $c_i(\gamma^n)$  to  $c_i(\gamma^{n-1})$ . This statement is clear for  $i = n$ , so we may assume that  $i < n$ . By the definition of Chern classes, the image  $\pi_0^*c_i(\gamma^n)$  is equal to  $c_i(\gamma_0^n)$ . But  $f : E_0 \rightarrow G_{n-1}$  is clearly covered by a bundle map  $\gamma_0^n \rightarrow \gamma^{n-1}$ . Therefore  $f^*c_i(\gamma^{n-1}) = c_i(\gamma_0^n)$  by 14.2, and it follows that

$$\lambda c_i(\gamma^n) = f^{*-1}\pi_0^*c_i(\gamma^n)$$

is equal to  $c_i(\gamma^{n-1})$  as asserted.

Now let us apply the induction hypothesis. Since  $H^*(G_{n-1})$  is generated by the Chern classes  $c_1(\gamma^{n-1}), \dots, c_{n-1}(\gamma^{n-1})$ , it follows that the homomorphism  $\lambda$  is surjective, so our sequence reduces to

$$0 \longrightarrow H^i(G_n) \xrightarrow{\cup c_n} H^{i+2n}(G_n) \xrightarrow{\lambda} H^{i+2n}(G_{n-1}) \longrightarrow 0 .$$

Using this sequence, we will prove, by a subsidiary induction on  $i$ , that every element  $x$  of  $H^{i+2n}(G_n)$  can be expressed *uniquely* as a polynomial in the Chern classes  $c_1(y^n), \dots, c_n(y^n)$ . Certainly the image  $\lambda(x)$  can be expressed uniquely as a polynomial  $p(c_1(y^{n-1}), \dots, c_{n-1}(y^{n-1}))$  by our main induction hypothesis. Therefore the element  $x - p(c_1(y^n), \dots, c_{n-1}(y^n))$  belongs to the kernel of  $\lambda$ , and hence can be expressed as a product  $yc_n(y^n)$  for some uniquely determined  $y \in H^i(G_n)$ . Now  $y$  can be expressed uniquely as a polynomial  $q(c_1(y^n), \dots, c_n(y^n))$  by our subsidiary induction hypothesis, hence

$$x = p(c_1(y^n), \dots, c_{n-1}(y^n)) + c_n(y^n)q(c_1(y^n), \dots, c_n(y^n)) . .$$

The polynomials on the right are unique, since if  $x$  were also equal to  $p'(c_1(y^n), \dots, c_{n-1}(y^n)) + c_n(y^n)q'(c_1(y^n), \dots, c_n(y^n))$  then applying  $\lambda$  we would see that  $p = p'$ , and dividing the difference by  $c_n(y^n)$  we would see that  $q = q'$ . ■

Just as for real  $n$ -plane bundles (§5.6), we can prove:

**THEOREM 14.6.** *Every complex  $n$ -plane bundle over a paracompact base space possesses a bundle map into the canonical complex  $n$ -plane bundle  $\gamma^n = \gamma^n(\mathbb{C}^\infty)$  over  $G_n = G_n(\mathbb{C}^\infty)$ .*

In other words every complex  $n$ -plane bundle over the paracompact base  $B$  is isomorphic to the induced bundle  $f^*(\gamma^n)$  for some  $f: B \rightarrow G_n$ . In fact, just as in the real case, one can actually prove the sharper statement that *two induced bundles  $f^*(\gamma^n)$  and  $g^*(\gamma^n)$  are isomorphic if and only if  $f$  is homotopic to  $g$* . For this reason the bundle  $\gamma^n = \gamma^n(\mathbb{C}^\infty)$  is called the *universal complex  $n$ -plane bundle*, and its base space  $G_n(\mathbb{C}^\infty)$  is called the *classifying space* for complex  $n$ -plane bundles. [The notation  $BU(n)$  is often used in the literature for this classifying space.]

### The Product Theorem for Chern Classes

Consider two complex vector bundles  $\omega$  and  $\phi$  over a common paracompact base space  $B$ . We want to prove the formula

$$(14.7) \quad c(\omega \oplus \phi) = c(\omega) c(\phi)$$

which expresses the total Chern class of a Whitney sum  $\omega \oplus \phi$  in terms of the total Chern classes of  $\omega$  and  $\phi$ . As a first step in this direction, we prove the following.

**LEMMA 14.8.** *There exists one and only one polynomial*

$$p_{m,n} = p_{m,n}(c_1, \dots, c_m; c'_1, \dots, c'_n)$$

*with integer coefficients in  $m+n$  indeterminates so that the identity*

$$c(\omega \oplus \phi) = p_{m,n}(c_1(\omega), \dots, c_m(\omega); c_1(\phi), \dots, c_n(\phi))$$

*is valid for every complex  $m$ -plane bundle  $\omega$  and every complex  $n$ -plane bundle  $\phi$  over a common paracompact base space  $B$ .*

*Proof.* As a universal model for pairs of complex vector bundles over a common base space we take the two vector bundles  $\gamma_1^m$  and  $\gamma_2^n$  over  $G_m \times G_n$  constructed as follows. Let  $\gamma_1^m = \pi_1^*(\gamma^m)$  where  $\pi_1 : G_m \times G_n \rightarrow G_m$  is the projection map to the first factor. Similarly let  $\gamma_2^n = \pi_2^*(\gamma^n)$  where  $\pi_2$  is the projection map to the second factor. Thus the Whitney sum  $\gamma_1^m \oplus \gamma_2^n$  can be identified with the cartesian product bundle  $\gamma^m \times \gamma^n$ .

We will make use of the fact that the external cohomology cross-product operation

$$a, b \mapsto a \times b = \pi_1^* a \cup \pi_2^* b$$

induces an isomorphism

$$H^*(G_m) \otimes H^*(G_n) \rightarrow H^*(G_m \times G_n)$$

of integral cohomology. In fact, for the case of finite CW-complexes  $K$  and  $L$  with  $H^*(L)$  free abelian, the Künneth isomorphism  $H^*(K) \otimes H^*(L) \cong H^*(K \times L)$  is established in Appendix A. The corresponding assertion for our infinite CW-complexes  $G_m$  and  $G_n$  follows immediately, since each skeleton of  $G_m$  or  $G_n$  is finite.

Therefore  $H^*(G_m \times G_n)$  is a polynomial ring over  $\mathbb{Z}$  on the algebraically independent generators

$$\pi_1^* c_i(y_1^m) = c_i(y_1^m), \quad 1 \leq i \leq m,$$

and

$$\pi_2^* c_j(y_2^n) = c_j(y_2^n), \quad 1 \leq j \leq n.$$

Hence the total Chern class of  $y_1^m \oplus y_2^n$  can be expressed *uniquely* as a polynomial

$$c(y_1^m \oplus y_2^n) = p_{m,n}(c_1(y_1^m), \dots, c_m(y_1^m); c_1(y_2^n), \dots, c_n(y_2^n)).$$

Now if  $\omega$  is a complex  $m$ -plane bundle over  $B$  and  $\phi$  is a complex  $n$ -plane bundle over  $B$ , we can choose maps  $f: B \rightarrow G_m$  and  $g: B \rightarrow G_n$  so that

$$f^*(y_1^m) \cong \omega, \quad g^*(y_2^n) \cong \phi.$$

Defining the map  $h: B \rightarrow G_m \times G_n$  by  $h(b) = (f(b), g(b))$ , note that the following diagram is commutative.

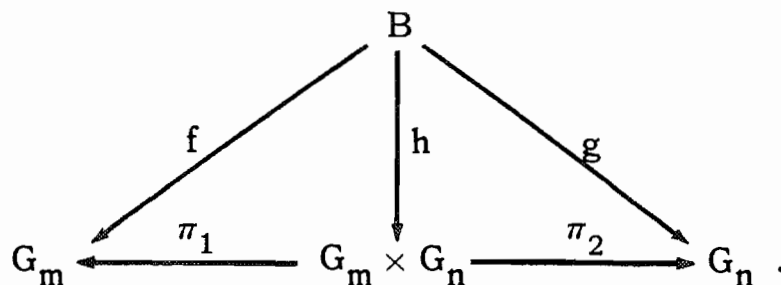

It follows that

$$h^*(y_1^m) \cong \omega, \quad h^*(y_2^n) \cong \phi$$

and hence

$$\begin{aligned} c(\omega \oplus \phi) &= h^* c(\gamma_1^m \oplus \gamma_2^n) \\ &= P_{m,n}(c_1(\omega), \dots, c_m(\omega); c_1(\phi), \dots, c_n(\phi)) \end{aligned}$$

as required. ■

To actually compute these polynomials  $P_{m,n}$  we proceed by induction on  $m+n$  as follows. Suppose inductively that  $c(\gamma_1^{m-1} \oplus \gamma_2^n)$  is equal to

$$(1 + c_1(\gamma_1^{m-1}) + \dots + c_{m-1}(\gamma_1^{m-1}))(1 + c_1(\gamma_2^n) + \dots + c_n(\gamma_2^n)) .$$

Consider the two vector bundles  $\gamma_1^{m-1} \oplus \varepsilon^1$  and  $\gamma_2^n$  over  $G_{m-1} \times G_n$ , where  $\varepsilon^1$  is a trivial line bundle. By 14.8 we have

$$c(\gamma_1^{m-1} \oplus \varepsilon^1 \oplus \gamma_2^n) = P_{m,n}(c_1(\gamma_1^{m-1} \oplus \varepsilon^1), \dots, c_m(\gamma_1^{m-1} \oplus \varepsilon^1); c_1(\gamma_2^n), \dots, c_n(\gamma_2^n)) .$$

But according to 14.3 the  $\varepsilon^1$  summand can always be ignored, so we have the alternative formula

$$\begin{aligned} c(\gamma_1^{m-1} \oplus \gamma_2^n) &= c(\gamma_1^{m-1} \oplus \varepsilon^1 \oplus \gamma_2^n) \\ &= P_{m,n}(c_1(\gamma_1^{m-1}), \dots, c_{m-1}(\gamma_1^{m-1}), 0; c_1(\gamma_2^n), \dots, c_n(\gamma_2^n)) . \end{aligned}$$

Comparing the induction hypothesis, and substituting indeterminates  $c_i$  and  $c'_j$  for the algebraically independent elements  $c_i(\gamma_1^{m-1})$  and  $c_j(\gamma_2^n)$ , this yields

$$P_{m,n}(c_1, \dots, c_{m-1}, 0; c'_1, \dots, c'_n) = (1 + c_1 + \dots + c_{m-1})(1 + c'_1 + \dots + c'_n) .$$

Introducing a new indeterminate  $c_m$ , it follows that the congruence

$$P_{m,n}(c_1, \dots, c_m; c'_1, \dots, c'_n) \equiv (1 + c_1 + \dots + c_m)(1 + c'_1 + \dots + c'_n) \pmod{c_m}$$

is valid in the polynomial ring  $Z[c_1, \dots, c_m, c'_1, \dots, c'_n]$ . A similar inductive argument shows that these two polynomials are congruent modulo  $c'_n$ .

Since  $\mathbb{Z}[c_1, \dots, c_m, c'_1, \dots, c'_n]$  is a unique factorization domain, it follows that they are congruent modulo the product  $c_m c'_n$ ; that is

$$p_{m,n}(c_1, \dots, c_m; c'_1, \dots, c'_n) = (1 + c_1 + \dots + c_m)(1 + c'_1 + \dots + c'_n) + u c_m c'_n$$

for some polynomial  $u$ . Here  $u$  must be zero dimensional, hence an integer, since otherwise the Whitney sum  $\gamma_1^m \oplus \gamma_2^n$  would have non-zero Chern classes in dimensions greater than  $2(m + n)$ .

But the top Chern class  $c_{m+n}(\omega \oplus \phi)$  can be identified with the Euler class

$$e((\omega \oplus \phi)_{\mathbb{R}}) = e(\omega_{\mathbb{R}} \oplus \phi_{\mathbb{R}}) ,$$

and hence is equal to the product  $c_m(\omega) c_n(\phi)$ . (Compare 9.6 and the discussion following 14.1.) Therefore the coefficient  $u$  must be zero, and we have proved the product formula 14.7. ■

### Dual or Conjugate Bundles

If  $\omega$  is a complex vector bundle, the *conjugate bundle*  $\bar{\omega}$  is defined to be the complex vector bundle with the same underlying real vector bundle

$$\omega_{\mathbb{R}} = \bar{\omega}_{\mathbb{R}} ,$$

but with the “opposite” complex structure. Thus the identity map  $f: E(\omega) \rightarrow E(\bar{\omega})$  is conjugate linear,

$$f(\lambda e) = \bar{\lambda} f(e)$$

for every complex number  $\lambda$  and every  $e \in E(\omega)$ . Here  $\bar{\lambda}$  denotes the complex conjugate of  $\lambda$ . In particular it follows that  $f(ie) = -if(e)$ .

As an example, consider the tangent bundle  $\tau^1$  of the complex manifold  $P^1(\mathbb{C})$ . (Ignoring the complex structure, this is just the tangent bundle of the 2-sphere.) This bundle  $\tau^1$  is *not* isomorphic to its conjugate bundle  $\bar{\tau}^1$ . For any isomorphism  $\tau^1 \rightarrow \bar{\tau}^1$  would have to map each tangent plane of the 2-sphere onto itself so as to reverse the complex structure (rotation by  $i$ ). Clearly any such map is obtained by reflection

in some uniquely defined line in the plane. But we have seen in §9.3 that the 2-sphere does not admit any continuous field of tangent lines.

The Chern classes of a conjugate bundle can be computed as follows.

LEMMA 14.9. *The Chern class  $c_k(\bar{\omega})$  is equal to  $(-1)^k c_k(\omega)$ .*

*Hence  $c(\bar{\omega}) = 1 - c_1(\omega) + c_2(\omega) - + \dots \pm c_n(\omega)$ .*

*Proof.* For any fiber  $F$  of  $\omega$ , choose a basis  $v_1, \dots, v_n$  for  $F$  over  $\mathbb{C}$ . Then the basis  $v_1, iv_1, \dots, v_n, iv_n$  for the underlying real vector space  $F_{\mathbb{R}}$  determines the preferred orientation for  $F_{\mathbb{R}}$ . Similarly the basis  $v_1, -iv_1, \dots, v_n, -iv_n$  determines the preferred orientation for the conjugate vector space. Thus the two oriented real vector bundles  $\omega_{\mathbb{R}}$  and  $(\bar{\omega})_{\mathbb{R}}$  have the same orientation if  $n$  is even, but the opposite orientation if  $n$  is odd. It follows immediately that the top Chern class

$$c_n(\omega) = e(\omega_{\mathbb{R}})$$

is equal to  $(-1)^n c_n(\bar{\omega})$ . To compute  $c_k(\bar{\omega})$  for  $k < n$ , we recall the definition  $c_k(\omega) = \pi_0^{*-1} c_k(\omega_0)$  where  $\omega_0$  is a canonical  $(n-1)$ -plane bundle over the space  $E_0 \subset E(\omega)$ . It is easy to check that the conjugate bundle  $\overline{(\omega_0)}$  is canonically isomorphic to  $(\bar{\omega})_0$ , so a straightforward induction shows that

$$c_k(\bar{\omega}) = (-1)^k c_k(\omega)$$

for all  $k$ . ■

Closely related to the conjugate bundle  $\bar{\omega}$  is the *dual bundle*  $\text{Hom}_{\mathbb{C}}(\omega, \mathbb{C})$ . By definition this is the complex vector bundle over the same base space whose typical fiber is equal to the dual  $\text{Hom}_{\mathbb{C}}(F, \mathbb{C})$  of the corresponding fiber  $F$  of  $\omega$ . (Compare the analogous discussion for real vector bundles beginning on p. 31.) To simplify the notation, we will usually omit the subscript  $\mathbb{C}$ .

*If the complex vector bundle  $\omega$  possesses a Hermitian metric, note that its dual bundle  $\text{Hom}(\omega, \mathbb{C})$  is canonically isomorphic to the conjugate bundle  $\bar{\omega}$ . For if we are given a Hermitian inner product*

$$\langle v_1, v_2 \rangle \in \mathbb{C}$$

on the typical fiber  $F$ , linear in the first variable and conjugate linear in the second, then the correspondence

$$v_2 \mapsto \langle \cdot, v_2 \rangle$$

maps the conjugate vector space  $\bar{F}$  isomorphically to the dual vector space  $\text{Hom}(F, \mathbb{C})$ .

### The Tangent Bundle of Complex Projective Space

As an application, consider the tangent bundle  $\tau^n$  of the projective space  $P^n(\mathbb{C})$ .

**THEOREM 14.10.** *The total Chern class  $c(\tau^n)$  is equal to  $(1+a)^{n+1}$  where  $a$  is a suitably chosen generator for the group  $H^2(P^n(\mathbb{C}); \mathbb{Z})$ .*

In fact we will see that  $a$  is the negative of the generator  $c_1(\gamma^1)$  which was used in 14.4.

*Proof.* Let  $\gamma^1 = \gamma^1(\mathbb{C}^{n+1})$  be the canonical line bundle over  $P^n(\mathbb{C})$ , and let  $\omega^n$  be its orthogonal complement, using the standard Hermitian metric on  $\mathbb{C}^{n+1}$ , so that the Whitney sum  $\gamma^1 \oplus \omega^n$  is a trivial complex  $(n+1)$ -plane bundle over  $P^n(\mathbb{C})$ . We will show that the complex vector bundle

$$\text{Hom}_{\mathbb{C}}(\gamma^1, \omega^n)$$

can be identified with the tangent bundle  $\tau^n$  of  $P^n(\mathbb{C})$ . In fact if  $L$  is a complex line through the origin in  $\mathbb{C}^{n+1}$ , and  $L^\perp$  is its orthogonal complement, then the vector space  $\text{Hom}(L, L^\perp)$  can be identified, complex analytically, with the neighborhood of  $L$  in  $P^n(\mathbb{C})$  consisting of all lines  $L'$  which can be considered as graphs of linear maps from  $L$  to  $L^\perp$ .



(Compare pp. 58, 70, as well as §4.4.) It follows easily that the tangent space of  $P^n(\mathbb{C})$  at  $L$  can be identified with  $\text{Hom}(L, L^\perp)$ , and hence that  $\tau^n \cong \text{Hom}(\gamma^1, \omega^n)$ .

Now adding the trivial bundle  $\varepsilon^1 \cong \text{Hom}(\gamma^1, \gamma^1)$  to both sides of the equation  $\tau^n \cong \text{Hom}(\gamma^1, \omega^n)$  it follows that

$$\begin{aligned}\tau^n \oplus \varepsilon^1 &\cong \text{Hom}(\gamma^1, \omega^n \oplus \gamma^1) \\ &\cong \text{Hom}(\gamma^1, \varepsilon^1 \oplus \dots \oplus \varepsilon^1) .\end{aligned}$$

Clearly this can be identified with the Whitney sum of  $n + 1$  copies of the dual bundle  $\text{Hom}(\gamma^1, \varepsilon^1) \cong \bar{\gamma}^1$ . Thus the total Chern class  $c(\tau^n) = c(\tau^n \oplus \varepsilon^1)$  is equal to

$$c(\bar{\gamma}^1)^{n+1} = (1 - c_1(\gamma^1))^{n+1} ,$$

using 14.9. Setting  $a = -c_1(\gamma^1)$ , the conclusion follows. ■

REMARK. It follows that the top Chern class  $c_n(\tau^n)$  is equal to  $(n+1)a^n$ . Therefore the Euler number

$$\begin{aligned}e[P^n(\mathbb{C})] &= c_n[P^n(\mathbb{C})] \\ &= \langle c_n(\tau^n), \mu_{2n} \rangle\end{aligned}$$

is equal to  $n+1$  multiplied by the sign  $\langle a^n, \mu_{2n} \rangle = \pm 1$ . Here  $\mu_{2n}$  denotes the fundamental homology class of  $P^n(\mathbb{C})$ . Setting this Euler number equal to

$$\sum (-1)^i \text{rank } H^i(P^n(\mathbb{C})) = n + 1$$

by §11.12, it follows that the sign  $\langle a^n, \mu_{2n} \rangle$  is actually  $+1$ . Thus  $a^n$  is precisely the generator of  $H^{2n}(P^n(\mathbb{C}); \mathbb{Z})$  which is compatible with the preferred orientation.

Here are some exercises for the reader.

*Problem 14-A.* Use Lemma 14.9 to give another proof that the tangent bundle of  $P^1(\mathbb{C})$  is not isomorphic to its conjugate bundle.

*Problem 14-B.* Using §9.5, prove inductively that the coefficient homomorphism  $H^i(B; \mathbb{Z}) \rightarrow H^i(B; \mathbb{Z}/2)$  maps the total Chern class  $c(\omega)$  to the total Stiefel-Whitney class  $w(\omega_{\mathbb{R}})$ . In particular show that the odd Stiefel-Whitney classes of  $\omega_{\mathbb{R}}$  are zero.

*Problem 14-C.* Let  $V_{n-q}(\mathbb{C}^n)$  denote the complex Stiefel manifold consisting of all complex  $(n-q)$ -frames in  $\mathbb{C}^n$ , where  $0 \leq q < n$ . According to [Steenrod, §25.7] this manifold is  $2q$ -connected, and

$$\pi_{2q+1} V_{n-q}(\mathbb{C}^n) \cong \mathbb{Z} .$$

Given a complex  $n$ -plane bundle  $\omega$  over a CW-complex  $B$  with typical fiber  $F$ , construct an associated bundle  $V_{n-q}(\omega)$  over  $B$  with typical fiber  $V_{n-q}(F)$ . Show that the primary obstruction to the existence of a cross-section of  $V_{n-q}(\omega)$  is a cohomology class in

$$H^{2q+2}(B; \{\pi_{2q+1} V_{n-q}(F)\})$$

which can be identified with the Chern class  $c_{q+1}(\omega)$ .

*Problem 14-D.* In analogy with §6, construct a cell subdivision for the complex Grassmann manifold  $G_n(\mathbb{C}^\infty)$  with one cell of dimension  $2k$  corresponding to each partition of  $k$  into at most  $n$  integers. Show that the Chern class  $c_k(\gamma^n)$  corresponds to the cocycle which assigns  $\pm 1$  to the Schubert cell indexed by the partition  $1, 1, \dots, 1$  of  $k$ , and zero to all other cells. (Compare Problem 6-C.)

*Problem 14-E.* In analogy with the construction of Chern classes, show that it is possible to define the Stiefel-Whitney classes of a real  $n$ -plane bundle inductively by the formula  $w_i(\xi) = \pi_0^{*-1} w_i(\xi_0)$  for  $i < n$ . Here the top Stiefel-Whitney class  $w_n(\xi)$  must be constructed by the procedure of §9 (p. 98), as a mod 2 analogue of the Euler class. [In this approach there is some difficulty in showing that  $w_{n-1}(\xi_0)$  belongs to the image of  $\pi_0^*$ . It suffices to show that  $w_{n-1}(\xi_0)$  restricts to zero in

each fiber  $F_0$ , or equivalently that the tangent bundle  $\tau$  of the  $(n-1)$ -sphere satisfies  $w_{n-1}(\tau) = 0$ . Compare pp. 41-42. It is at this point that mod 2 coefficients are essential, since  $e(\tau) \neq 0$  in general.] Using this construction of Stiefel-Whitney classes, verify the axioms of §4 without making any use of Steenrod squares.

## §15. Pontrjagin Classes

To obtain further information about real vector bundles we will need the following construction. Let  $V$  be a real vector space. Then the tensor product  $V \otimes \mathbb{C} = V \otimes_{\mathbb{R}} \mathbb{C}$  of  $V$  with the complex numbers is a complex vector space called the *complexification* of  $V$ . Applying this construction to each fiber  $F$  of a real  $n$ -plane bundle  $\xi$  we obtain a complex  $n$ -plane bundle with typical fiber  $F \otimes \mathbb{C}$  over the same base space. We denote this new bundle by  $\xi \otimes \mathbb{C}$  and call it the *complexification* of the real vector bundle  $\xi$ .

Note that every element in the complex vector space  $F \otimes \mathbb{C}$  can be written uniquely as a sum  $x + iy$  with  $x, y \in F$ . Using this real direct sum decomposition

$$F \otimes \mathbb{C} = F \oplus iF$$

it follows that *the underlying real vector bundle  $(\xi \otimes \mathbb{C})_{\mathbb{R}}$  is canonically isomorphic to the Whitney sum  $\xi \oplus \xi$* . Evidently the given complex structure on  $\xi \otimes \mathbb{C}$  corresponds to the complex structure

$$J(x, y) = (-y, x)$$

on this Whitney sum  $\xi \oplus \xi$ .

**LEMMA 15.1.** *The complexification  $\xi \otimes \mathbb{C}$  of a real vector bundle is always isomorphic to its own conjugate bundle  $\overline{\xi \otimes \mathbb{C}}$ .*

For the correspondence  $f: x + iy \mapsto x - iy$ , maps the total space  $E(\xi \otimes \mathbb{C})$  homeomorphically onto itself, and is  $\mathbb{R}$ -linear in each fiber with  $f(i(x + iy)) = -if(x + iy)$ . ■

Now consider the total Chern class

$$c(\xi \otimes \mathbb{C}) = 1 + c_1(\xi \otimes \mathbb{C}) + c_2(\xi \otimes \mathbb{C}) + \dots + c_n(\xi \otimes \mathbb{C})$$

of this complexified  $n$ -plane bundle. Setting this equal to

$$\overline{c(\xi \otimes \mathbb{C})} = 1 - c_1(\xi \otimes \mathbb{C}) + c_2(\xi \otimes \mathbb{C}) - \dots \pm c_n(\xi \otimes \mathbb{C})$$

by 14.9, we see that the odd Chern classes

$$c_1(\xi \otimes \mathbb{C}), c_3(\xi \otimes \mathbb{C}), \dots$$

are all elements of order 2. (Compare Problem 15-D.)

**DEFINITION.** Ignoring these elements of order 2, the  $i$ -th *Pontrjagin class*

$$p_i(\xi) \in H^{4i}(B; \mathbb{Z})$$

is defined to be the integral cohomology class  $(-1)^i c_{2i}(\xi \otimes \mathbb{C})$ . The sign  $(-1)^i$  is introduced here so as to avoid a sign in later formulas (15.8, 15.6). Evidently  $p_i(\xi)$  is zero for  $i > n/2$ . The *total Pontrjagin class* is defined to be the unit

$$p(\xi) = 1 + p_1(\xi) + \dots + p_{[n/2]}(\xi)$$

in the ring  $H^{\Pi}(B; \mathbb{Z})$ . Here  $[n/2]$  denotes the largest integer less than or equal to  $n/2$ .

**LEMMA 15.2.** *Pontrjagin classes are natural with respect to bundle maps. Furthermore, if  $\varepsilon^k$  is a trivial  $k$ -plane bundle, then  $p(\xi \oplus \varepsilon^k) = p(\xi)$ .*

*Proof.* This follows immediately from 14.2 and 14.3. ■

In analogy with the other characteristic classes we have studied, we would like the Pontrjagin classes to satisfy a product formula. There is

some difficulty however, since the odd Chern classes of  $\xi \otimes \mathbb{C}$  have been thrown away, so the best we can do is the following.

**THEOREM 15.3.** *The total Pontrjagin class  $p(\xi \oplus \eta)$  of a Whitney sum is congruent to  $p(\xi)p(\eta)$  modulo elements of order 2. In other words  $2(p(\xi \oplus \eta) - p(\xi)p(\eta)) = 0$ .*

*Proof.* Since  $(\xi \oplus \eta) \otimes \mathbb{C}$  is clearly isomorphic to  $(\xi \otimes \mathbb{C}) \oplus (\eta \otimes \mathbb{C})$  we have

$$c_k((\xi \oplus \eta) \otimes \mathbb{C}) = \sum_{i+j=k} c_i(\xi \otimes \mathbb{C}) c_j(\eta \otimes \mathbb{C}) .$$

Ignoring the odd Chern classes, which are all elements of order 2, it follows that

$$c_{2k}((\xi \oplus \eta) \otimes \mathbb{C}) \equiv \sum_{i+j=k} c_{2i}(\xi \otimes \mathbb{C}) c_{2j}(\eta \otimes \mathbb{C})$$

modulo elements of order 2. Multiplying both sides of this congruence by  $(-1)^k = (-1)^i(-1)^j$ , it follows that

$$p_k(\xi \oplus \eta) \equiv \sum_{i+j=k} p_i(\xi) p_j(\eta) ,$$

as required. ■

*Example.* For the tangent bundle  $\tau^n$  of the  $n$ -sphere, since the Whitney sum  $\tau^n \oplus \nu^1 \cong \tau^n \oplus \varepsilon^1$  is trivial, it follows by 15.2 that the total Pontrjagin class  $p(\tau^n)$  is equal to 1.

Thus the Pontrjagin classes of the tangent bundle of a sphere are uninteresting. To obtain some interesting examples we will look at complex projective spaces. But first we must develop a further relationship between Pontrjagin classes and Chern classes.

At this point, we have a situation which can be represented schematically by the following diagram.

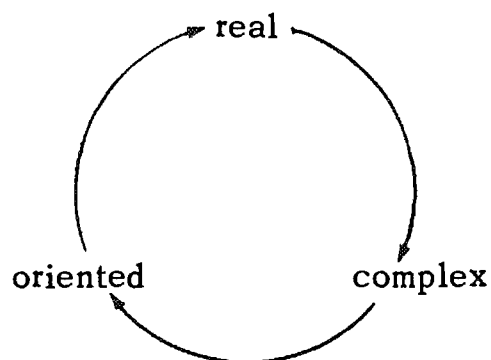

Starting with a real  $n$ -plane bundle  $\xi$ , we can first form the induced complex  $n$ -plane bundle  $\xi \otimes \mathbb{C}$ . Then, forgetting the complex structure, we obtain the underlying real  $2n$ -plane bundle  $(\xi \otimes \mathbb{C})_{\mathbb{R}}$  with a canonical preferred orientation. Finally, forgetting the orientation, this resulting real  $2n$ -plane bundle can be identified simply with the Whitney sum  $\xi \oplus \xi$ .

However, instead of starting at the top of the circle (i.e., with a real vector bundle), we can equally well start somewhere else on the circle. After circumnavigating the circle we will then obtain a new bundle of the same type (complex or oriented) as the bundle we started with, but with twice the dimension of the original bundle. Suppose for example that we start with a complex vector bundle.

**LEMMA 15.4.** *For any complex vector bundle  $\omega$ , the complexification  $\omega_{\mathbb{R}} \otimes \mathbb{C}$  of the underlying real vector bundle is canonically isomorphic to the Whitney sum  $\omega \oplus \bar{\omega}$ .*

*Proof.* For any real vector space  $V$ , recall that  $V \otimes \mathbb{C}$  can be identified with the direct sum  $V \oplus V$ , made into a complex vector space by means of the complex structure  $J(x, y) = (-y, x)$ .

Now suppose that  $V = F_{\mathbb{R}}$  where  $F$  is the typical fiber of a complex vector bundle. Then it is easy to verify that the correspondence

$$g : x \mapsto (x, -ix)$$

from  $F$  to  $V \oplus V$  is complex linear, that is  $g(ix) = J(g(x))$ . Similarly the correspondence

$$h : x \mapsto (x, ix)$$

from  $F$  to  $V \oplus V$  is conjugate linear. Since every point  $(x, y)$  of  $V \oplus V \cong F_{\mathbb{R}} \otimes \mathbb{C}$  can be written uniquely as the sum

$$g\left(\frac{x+iy}{2}\right) + h\left(\frac{x-iy}{2}\right)$$

of an element in  $g(F)$  and an element in  $h(F)$ , it follows that  $F_{\mathbb{R}} \otimes \mathbb{C}$  is canonically isomorphic, as complex vector space to  $F \oplus \bar{F}$ . This is true for each fiber  $F$  of  $\omega$ , so combining all of these isomorphisms it follows that  $\omega_{\mathbb{R}} \otimes \mathbb{C} \cong \omega \oplus \bar{\omega}$  as asserted. ■

**COROLLARY 15.5.** *For any complex  $n$ -plane bundle  $\omega$ , the Chern classes  $c_i(\omega)$  determine the Pontrjagin classes  $p_k(\omega_{\mathbb{R}})$  by the formula*

$$1 - p_1 + p_2 - \dots \pm p_n = (1 - c_1 + c_2 - \dots \pm c_n)(1 + c_1 + c_2 + \dots + c_n).$$

Thus  $p_k(\omega_{\mathbb{R}})$  is equal to

$$c_k(\omega)^2 - 2c_{k-1}(\omega)c_{k+1}(\omega) + \dots \pm 2c_1(\omega)c_{2k-1}(\omega) \mp 2c_{2k}(\omega).$$

*Proof.* This follows immediately, making use of 14.7 and 14.9. ■

**Example 15.6.** Let  $\tau$  be the tangent bundle of the complex projective space  $P^n(\mathbb{C})$ . Since the total Chern class  $c(\tau)$  equals  $(1+a)^{n+1}$  by 14.10, it follows that the Pontrjagin classes  $p_k(\tau_{\mathbb{R}})$  are given by

$$\begin{aligned} (1 - p_1 + \dots \pm p_n) &= (1 - c_1 + \dots \pm c_n)(1 + c_1 + \dots + c_n) \\ &= (1 - a)^{n+1}(1 + a)^{n+1} = (1 - a^2)^{n+1}. \end{aligned}$$

Therefore the total Pontrjagin class  $1 + p_1 + \dots + p_n$  is equal to  $(1 + a^2)^{n+1}$ . In other words

$$p_k(P^n(\mathbb{C})) = \binom{n+1}{k} a^{2k}$$



for  $1 \leq k \leq n/2$ , where the higher Pontrjagin classes are zero since  $H^{4k}(P^n(\mathbb{C})) = 0$  for  $k > n/2$ . Here we are using the abbreviation  $p_k(M)$  for the tangential Pontrjagin class  $p_k(\tau(M)_{\mathbb{R}})$  of a complex manifold  $M$ .

Thus

$$p(P^1(\mathbb{C})) = 1$$

$$p(P^2(\mathbb{C})) = 1 + 3a^2$$

$$p(P^3(\mathbb{C})) = 1 + 4a^2$$

$$p(P^4(\mathbb{C})) = 1 + 5a^2 + 10a^4$$

$$p(P^5(\mathbb{C})) = 1 + 6a^2 + 15a^4$$

$$p(P^6(\mathbb{C})) = 1 + 7a^2 + 21a^4 + 35a^6 ,$$

and so on. From these examples we see that Pontrjagin classes can well be non-zero.

Now suppose we start with an oriented  $n$ -plane bundle  $\xi$ . Complexifying and then passing to the underlying real vector bundle, we obtain a  $2n$ -plane bundle  $(\xi \otimes \mathbb{C})_{\mathbb{R}}$  with a preferred orientation by 14.1.

**LEMMA 15.7.** *The real  $2n$ -plane bundle  $(\xi \otimes \mathbb{C})_{\mathbb{R}}$  is isomorphic to  $\xi \oplus \xi$  under an isomorphism which either preserves or reverses orientation according as  $n(n-1)/2$  is even or odd.*

*Proof.* Let  $v_1, \dots, v_n$  be an ordered basis for a typical fiber  $F$  of  $\xi$ . Then the vectors  $v_1, iv_1, \dots, v_n, iv_n$  form an ordered basis determining the preferred orientation for  $(F \otimes \mathbb{C})_{\mathbb{R}}$ . Identifying this with the real direct sum  $F \oplus iF \cong F \oplus F$ , the basis  $v_1, \dots, v_n$  for  $F$  followed by the basis  $iv_1, \dots, iv_n$  for  $iF$  gives a different ordered basis. Evidently the permutation which transforms one ordered basis to the other has sign  $(-1)^{(n-1)+(n-2)+\dots+1} = (-1)^{n(n-1)/2}$ . ■

**COROLLARY 15.8.** *If  $\xi$  is an oriented  $2k$ -plane bundle, then the Pontrjagin class  $p_k(\xi)$  is equal to the square of the Euler class  $e(\xi)$ .*

For by definition  $p_k(\xi)$  is equal to  $(-1)^k c_{2k}(\xi \otimes \mathbb{C}) = (-1)^k e((\xi \otimes \mathbb{C})_{\mathbb{R}})$ . But, according to 15.7 and 9.6, the Euler class  $e((\xi \otimes \mathbb{C})_{\mathbb{R}})$  is equal to  $e(\xi \oplus \xi) = e(\xi)^2$  multiplied by the sign  $(-1)^{2k(2k-1)/2} = (-1)^k$ . ■

### The Cohomology of the Oriented Grassmann Manifold

Recall that  $\tilde{G}_n = \tilde{G}_n(\mathbb{R}^\infty)$  denotes the space of oriented real  $n$ -planes in  $\mathbb{R}^\infty$ . (The notation  $BSO(n)$  is often used for this classifying space.) We will study the cohomology of  $\tilde{G}_n$  with coefficients in an integral domain  $\Lambda$  containing  $\frac{1}{2}$ . This choice of coefficient domain has the effect of killing 2-torsion. The “universal” example of such a domain  $\Lambda$  is the ring  $\mathbb{Z}[\frac{1}{2}]$ . However our arguments will work equally well with coefficients in the field of rational numbers  $\mathbb{Q}$ , or in any field of characteristic  $\neq 2$ . The result will be only slightly more complicated than the cases  $H^*(G_n(\mathbb{R}^\infty); \mathbb{Z}/2)$ ,  $H^*(\tilde{G}_n; \mathbb{Z}/2)$ , and  $H^*(G_n(\mathbb{C}^\infty); \mathbb{Z})$  which we have already computed.

**THEOREM 15.9.** *If  $\Lambda$  is an integral domain containing  $\frac{1}{2}$ , then the cohomology ring  $H^*(\tilde{G}_{2m+1}; \Lambda)$  is a polynomial ring over  $\Lambda$  generated by the Pontrjagin classes*

$$p_1(\tilde{\gamma}^{2m+1}), \dots, p_m(\tilde{\gamma}^{2m+1}) .$$

*Similarly  $H^*(\tilde{G}_{2m}; \Lambda)$  is a polynomial ring over  $\Lambda$  generated by the Pontrjagin classes  $p_1(\gamma^{2m}), \dots, p_{m-1}(\gamma^{2m})$  and the Euler class  $e(\tilde{\gamma}^{2m})$ .*

In other words for every value of  $n$ , even or odd, the ring  $H^*(\tilde{G}_n; \Lambda)$  is generated by the characteristic classes  $p_1, \dots, p_{[n/2]}$ , and  $e$ . These generators are subject only to the relations:

$e = 0$  for  $n$  odd,

$e^2 = p_{n/2}$  for  $n$  even.

(Compare 9.4 and 15.8.) For the corresponding result with integer coefficients, see Problem 15-C.

*Proof by induction on  $n$ .* For  $n = 1$  the space  $\tilde{G}_1(\mathbb{R}^N)$  is clearly homeomorphic to the unit sphere  $S^{N-1}$ , and hence has the cohomology of a point in dimensions  $\leq N-2$ . Passing to the direct limit as  $N \rightarrow \infty$ , it follows that  $\tilde{G}_1$  has the cohomology of a point in all dimensions.

Suppose inductively that the Theorem has already been verified for  $\tilde{G}_{n-1}$ . Just as in the complex case (§14.5), there is an exact sequence

$$\dots \longrightarrow H^i(\tilde{G}_n) \xrightarrow{\cup e} H^{i+n}(\tilde{G}_n) \xrightarrow{\lambda} H^{i+n}(\tilde{G}_{n-1}) \longrightarrow H^{i+1}(\tilde{G}_n) \longrightarrow \dots$$

where  $e$  stands for the Euler class  $e(\tilde{\gamma}^n)$ , and where the ring homomorphism  $\lambda = f^{*-1}\pi_0^*$  maps the Pontrjagin classes of  $\tilde{\gamma}^n$  into those of  $\tilde{\gamma}^{n-1}$ . The coefficient ring  $\Lambda$  is to be understood.

Case 1. If  $n$  is even, then the argument is completely analogous to that in §14.5. The given exact sequence reduces to

$$0 \longrightarrow H^i(\tilde{G}_n) \xrightarrow{\cup e} H^{i+n}(\tilde{G}_n) \xrightarrow{\lambda} H^{i+n}(\tilde{G}_{n-1}) \longrightarrow 0 ,$$

where the cohomology of  $\tilde{G}_{n-1}$  is a polynomial ring generated by  $p_1, \dots, p_{(n/2)-1}$ . It follows easily that  $H^*(\tilde{G}_n)$  is a polynomial ring on the required generators  $p_1, \dots, p_{(n/2)-1}$ , and  $e$ .

Case 2. Suppose that  $n$  is odd, say  $n = 2m+1$ . Then the Euler class of  $\tilde{\gamma}^n$  with coefficients in  $\Lambda$  is zero, so the exact sequence reduces to

$$0 \longrightarrow H^j(\tilde{G}_{2m+1}) \xrightarrow{\lambda} H^j(\tilde{G}_{2m}) \longrightarrow H^{j-2m}(\tilde{G}_{2m+1}) \longrightarrow 0 .$$

Thus  $H^*(\tilde{G}_{2m+1})$  can be considered as a sub-ring of  $H^*(\tilde{G}_{2m})$ .

It will be convenient to introduce the abbreviation  $A^*$  for the polynomial algebra  $\Lambda[p_1, \dots, p_m] \subset H^*(\tilde{G}_{2m})$ . Then clearly

$$A^* \subset \lambda(H^*(\tilde{G}_{2m+1})) ,$$

and we must prove that equality holds. It follows of course that the inequality

$$(1) \quad \text{rank } A^j \leq \text{rank } H^j(\tilde{G}_{2m+1})$$

is satisfied for each dimension  $j$ . (Here the *rank* of a  $\Lambda$ -module means the maximal number of elements linearly independent over  $\Lambda$ . Compare [Eilenberg and Steenrod, p. 52].)

Using the induction hypothesis we see easily that every element of  $H^j(\tilde{G}_{2m})$  can be written uniquely as a sum  $a + ea'$  with  $a \in A^j$  and  $a' \in A^{j-2m}$ . (Here  $e$  denotes the Euler class of  $\tilde{\gamma}^{2m}$ , with  $e^2 = p_m$ .) This direct sum decomposition  $H^j(\tilde{G}_{2m}) \cong A^j \oplus A^{j-2m}$  implies that

$$(2) \quad \text{rank } H^j(\tilde{G}_{2m}) = \text{rank } A^j + \text{rank } A^{j-2m} .$$

On the other hand, using the exact sequence above we see that

$$(3) \quad \text{rank } H^j(\tilde{G}_{2m}) = \text{rank } H^j(\tilde{G}_{2m+1}) + \text{rank } H^{j-2m}(\tilde{G}_{2m+1}) .$$

Combining (1), (2), and (3), it follows that

$$\text{rank } A^j = \text{rank } H^j(\tilde{G}_{2m+1}) .$$

But this implies that  $A^j$  is actually equal to the image  $\lambda(H^j(\tilde{G}_{2m+1}))$ . For otherwise  $\lambda(H^j(\tilde{G}_{2m+1}))$  would contain a sum  $a + e(\tilde{\gamma}^{2m})a'$  with  $a' \neq 0$ . This new element could not satisfy any linear relation with the basis elements of  $A^j$ , so strict inequality would have to hold in (1), yielding a contradiction. ■

As usual, we conclude with some problems for the reader.

*Problem 15-A.* Using Problem 14-B, prove that the mod 2 reduction of the Pontrjagin class  $p_i(\xi)$  is equal to the square of the Stiefel-Whitney class  $w_{2i}(\xi)$ .

*Problem 15-B.* Show that  $H^*(G_n(\mathbb{R}^\infty); \Lambda)$  is a polynomial ring over  $\Lambda$  generated by the Pontrjagin classes  $p_1(y^n), \dots, p_{[n/2]}(y^n)$ . [More generally, for any 2-fold covering space  $\tilde{X} \rightarrow X$  with covering transformation  $t: \tilde{X} \rightarrow \tilde{X}$ , show that  $H^*(X; \Lambda)$  can be identified with the fixed point set of the involution  $t^*$  of  $H^*(\tilde{X}; \Lambda)$ .]

*Problem 15-C.* Compute the cohomology of the cochain complex  $H^*(G_{2m+1}(\mathbb{R}^\infty); \mathbb{Z}/2)$  with respect to the differential operator  $Sq^1$ . [That is compute  $\text{Kernel}(Sq^1)/\text{Image}(Sq^1)$ . It is convenient to express this cohomology ring as the tensor product of a polynomial ring generated by  $w_1$ , and the polynomial rings generated by  $w_{2i}$  and  $Sq^1(w_{2i})$  for  $1 \leq i \leq m$ .] Using the Bockstein exact sequence

$$\dots \longrightarrow H^j(\ ; \mathbb{Z}) \xrightarrow{2} H^j(\ ; \mathbb{Z}) \xrightarrow{\rho} H^j(\ ; \mathbb{Z}/2) \xrightarrow{\beta} H^{j+1}(\ ; \mathbb{Z}) \longrightarrow \dots ,$$

where  $\rho \circ \beta = Sq^1$  (compare [Steenrod and Epstein, p. 2]), prove that  $H^*(G_{2m+1}(\mathbb{R}^\infty); \mathbb{Z})$  splits additively as the direct sum of the polynomial ring  $\mathbb{Z}[p_1, \dots, p_m]$  and the image of  $\beta$ . Prove the analogous statements for  $G_{2m}(\mathbb{R}^\infty)$  and  $\tilde{G}_n(\mathbb{R}^\infty)$ .

*Problem 15-D.* Using the preceding, prove that the odd Chern classes of  $\xi \otimes \mathbb{C}$  are given by

$$c_{2i+1}(\xi \otimes \mathbb{C}) = \beta(w_{2i}(\xi)w_{2i+1}(\xi)) .$$

Similarly, for an oriented  $(2k+1)$ -plane bundle  $\xi$ , prove that  $e(\xi) = \beta w_{2k}(\xi)$ .

## §16. Chern Numbers and Pontrjagin Numbers

In analogy with the Stiefel-Whitney numbers of a compact manifold, introduced on pp. 50-53, this section will introduce the Chern numbers of a compact complex manifold, and the Pontrjagin numbers of a compact oriented manifold. All manifolds are to be smooth.

### Partitions

Recall from §6.6 that a *partition* of a non-negative integer  $k$  is an unordered sequence  $I = i_1, \dots, i_r$  of positive integers with sum  $k$ . If  $I = i_1, \dots, i_r$  is a partition of  $k$  and  $J = j_1, \dots, j_s$  is a partition of  $\ell$ , then the juxtaposition

$$IJ = i_1, \dots, i_r, j_1, \dots, j_s$$

is a partition of  $k + \ell$ . This composition operation is associative, commutative, and has as identity element the vacuous partition of zero which we denote by the empty symbol  $\emptyset$ . (In more technical language, the set of all partitions of all non-negative integers can be regarded as a free commutative monoid on the generators  $1, 2, 3, \dots$ .)

A partial ordering among partitions is defined as follows. A *refinement* of a partition  $i_1, \dots, i_r$  will mean any partition which can be written as a juxtaposition  $I_1 \dots I_r$  where each  $I_j$  is a partition of  $i_j$ . If  $j_1, \dots, j_s$  is a refinement of  $i_1, \dots, i_r$  then it follows of course that  $s \geq r$ .

### Chern Numbers

Let  $K^n$  be a compact complex manifold of complex dimension  $n$ . Then for each partition  $I = i_1, \dots, i_r$  of  $n$ , the  $I$ -th *Chern number*

$$c_I[K^n] = c_{i_1} \dots c_{i_r}[K^n]$$

is defined to be the integer

$$\langle c_{i_1}(r^n) \dots c_{i_r}(r^n), \mu_{2n} \rangle .$$

Here  $r^n$  denotes the tangent bundle of  $K^n$ , and  $\mu_{2n}$  denotes the fundamental homology class determined by the preferred orientation. We adopt the convention that  $c_I[K^n]$  is zero if  $I$  is a partition of some integer other than  $n$ .

As an example, for the complex projective space  $P^n(\mathbb{C})$ , since  $c_i(r^n) = \binom{n+1}{i} a^i$  and  $\langle a^n, \mu_{2n} \rangle = +1$  by §14.10, we have the formula

$$c_{i_1} \dots c_{i_r} [P^n(\mathbb{C})] = \binom{n+1}{i_1} \dots \binom{n+1}{i_r}$$

for any partition  $i_1, \dots, i_r$  of  $n$ .

A complex 1-dimensional manifold  $K^1$  has just one Chern number, namely the Euler characteristic  $c_1[K^1]$ . For a complex 2-manifold there are two Chern numbers, namely  $c_1 c_1[K^2]$  and the Euler characteristic  $c_2[K^2]$ . In general, a complex  $n$ -manifold has  $p(n)$  Chern numbers, where  $p(n)$  is the number of distinct partitions of  $n$ . (Compare p. 80.) We will see in 16.7 that these  $p(n)$  Chern numbers are linearly independent; that is there is no linear relation between them which is satisfied for *all* complex  $n$ -manifolds.

There is another way of thinking about Chern classes which is important for many purposes. Note that the cohomology group  $H^{2n}(G_n(\mathbb{C}^\infty); \mathbb{Z})$  is free abelian of rank  $p(n)$ . The products  $c_{i_1}(r^n) \dots c_{i_r}(r^n)$ , where  $i_1, \dots, i_r$  ranges over all partitions of  $n$ , form a basis for this group. For any complex manifold  $K^n$  the tangent bundle  $r^n$  is "classified" by a map

$$f : K^n \rightarrow G_n(\mathbb{C}^\infty)$$

with  $f^*(r^n) \cong r^n$ . Using this classifying map  $f$ , the fundamental homology class  $\mu_{2n}$  of  $K^n$  gives rise to a homology class  $f_*(\mu_{2n})$  in the free abelian group  $H_{2n}(G_n(\mathbb{C}^\infty); \mathbb{Z})$  of rank  $p(n)$ . To identify this homology class  $f_*(\mu_{2n})$ , we need only compute the  $p(n)$  Kronecker indices

$$\langle c_{i_1}(y^n) \dots c_{i_r}(y^n), f_*(\mu_{2n}) \rangle ,$$

since the products  $c_{i_1}(y^n) \dots c_{i_r}(y^n)$  range over a basis for the corresponding cohomology group. But each such Kronecker index is equal to the Chern number

$$\langle f^*(c_{i_1}(y^n) \dots c_{i_r}(y^n)), \mu_{2n} \rangle = c_{i_1} \dots c_{i_r} [K^n] .$$

We see from this approach that it is not necessary to use the basis  $\{c_{i_1}(y^n) \dots c_{i_r}(y^n)\}$  for  $H^{2n}(G_n(\mathbb{C}^\infty); \mathbb{Z})$ . Any other basis would serve equally well. Later we will make use of a quite different basis for this group.

### Pontrjagin Numbers

Now consider a smooth, compact, oriented manifold  $M^{4n}$ . For each partition  $I = i_1, \dots, i_r$  of  $n$ , the  $I$ -th *Pontrjagin number*  $p_I[M^{4n}] = p_{i_1} \dots p_{i_r} [M^{4n}]$  is defined to be the integer

$$\langle p_{i_1}(\tau^{4n}) \dots p_{i_r}(\tau^{4n}), \mu_{4n} \rangle .$$

Here  $\tau^{4n}$  denotes the tangent bundle and  $\mu_{4n}$  the fundamental homology class.

As an example, the complex projective space  $P^{2n}(\mathbb{C})$ , with its complex structure forgotten, is a compact oriented manifold of real dimension  $4n$ . The Pontrjagin numbers of this manifold are given by the formula

$$p_{i_1} \dots p_{i_r} [P^{2n}(\mathbb{C})] = \binom{2n+1}{i_1} \dots \binom{2n+1}{i_r} ,$$

as one easily verifies using 15.6.

If we reverse the orientation of a manifold  $M^{4n}$ , note that its Pontrjagin classes remain unchanged, but its fundamental homology class  $\mu_{4n}$  changes sign. Hence each Pontrjagin number



$$p_{i_1} \dots p_{i_r} [M^{4n}] = \langle p_{i_1} \dots p_{i_r}, \mu_{4n} \rangle$$

also changes sign. Thus if some Pontrjagin number  $p_{i_1} \dots p_{i_r} [M^{4n}]$  is non-zero, then it follows that  $M^{4n}$  cannot possess any orientation reversing diffeomorphism.

As an example, the complex projective space  $P^{2n}(\mathbb{C})$  does not possess any orientation reversing diffeomorphism. (On the other hand,  $P^{2n+1}(\mathbb{C})$  does have an orientation reversing diffeomorphism, arising from complex conjugation.)

This behavior of Pontrjagin numbers is in contrast to the behavior of the Euler number  $e[M^{2n}]$  which is invariant under change of orientation. In fact the manifold  $S^{2n}$ , with  $e[S^{2n}] \neq 0$ , certainly does admit an orientation reversing diffeomorphism.

Furthermore, if some Pontrjagin number  $p_{i_1} \dots p_{i_r} [M^{4n}]$  is non-zero then, proceeding as in §4.9, we see that  $M^{4n}$  cannot be the boundary of any smooth, compact, oriented  $(4n+1)$ -dimensional manifold with boundary. (Compare §17.) For example, the projective space  $P^{2n}(\mathbb{C})$  cannot be an oriented boundary. In fact the disjoint union  $P^{2n}(\mathbb{C}) + \dots + P^{2n}(\mathbb{C})$  of any number of copies of  $P^{2n}(\mathbb{C})$  cannot be an oriented boundary, since the  $l$ -th Pontrjagin number of such a  $k$ -fold union is clearly just  $k$  times the  $l$ -th Pontrjagin number of  $P^{2n}(\mathbb{C})$  itself. Again this argument does not work for  $P^{2n+1}(\mathbb{C})$ . (In fact  $P^{2n+1}(\mathbb{C})$  is the total space of a circle-bundle over a quaternion projective space, and hence is the boundary of an associated disk-bundle.)

Again the corresponding statement for Euler numbers is also false. Thus  $e[S^{2n}] \neq 0$  even though  $S^{2n}$  clearly bounds an oriented manifold. All of these remarks are due to Pontrjagin.

### Symmetric Functions

The following classical algebraic techniques will enable us to define and manipulate certain useful linear combinations of Chern numbers or Pontrjagin numbers.

Let  $t_1, \dots, t_n$  be indeterminates. A polynomial function  $f(t_1, \dots, t_n)$ , say with integer coefficients, is called a *symmetric function* if it is invariant under all permutations of  $t_1, \dots, t_n$ . Thus the symmetric functions form a sub-ring

$$\mathfrak{S} \subset \mathbb{Z}[t_1, \dots, t_n] .$$

A familiar and fundamental theorem asserts that  $\mathfrak{S}$  itself is also a polynomial ring on  $n$  algebraically independent generators,

$$\mathfrak{S} = \mathbb{Z}[\sigma_1, \dots, \sigma_n] ,$$

where  $\sigma_k = \sigma_k(t_1, \dots, t_n)$  denotes the  $k$ -th *elementary symmetric function*, uniquely characterized by the fact that  $\sigma_k$  is a homogeneous polynomial of degree  $k$  in  $t_1, \dots, t_n$  with

$$1 + \sigma_1 + \sigma_2 + \dots + \sigma_n = (1+t_1)(1+t_2) \dots (1+t_n) .$$

(Compare p. 84.)

If we make  $\mathbb{Z}[t_1, \dots, t_n]$  into a graded ring by assigning each  $t_i$  the degree 1, then of course the symmetric functions form a graded subring  $\mathfrak{S}^* = \mathbb{Z}[\sigma_1, \dots, \sigma_n]$ , where each  $\sigma_k$  has degree  $k$ . Thus a basis for the additive group  $\mathfrak{S}^k$ , consisting of homogeneous symmetric polynomials of degree  $k$  in  $t_1, \dots, t_n$ , is given by the set of monomials

$$\sigma_{i_1} \dots \sigma_{i_r}$$

where  $i_1, \dots, i_r$  ranges over all partitions of  $k$  into integers  $\leq n$ .

A different and quite useful basis can be constructed as follows. Define two monomials in  $t_1, \dots, t_n$  to be *equivalent* if some permutation of  $t_1, \dots, t_n$  transforms one into the other. Define  $\sum t_1^{a_1} \dots t_r^{a_r}$  to be the summation of all monomials in  $t_1, \dots, t_n$  which are equivalent to  $t_1^{a_1} \dots t_r^{a_r}$ . As an example, using this notation we can write  $\sigma_k = \sum t_1 t_2 \dots t_k$ .

LEMMA 16.1. *An additive basis for  $\mathcal{S}^k$ , the group of homogeneous symmetric polynomials of degree  $k$  in  $t_1, \dots, t_n$ , is given by the polynomials  $\sum t_1^{a_1} \dots t_r^{a_r}$ . Here  $a_1, \dots, a_r$  ranges over all partitions of  $k$  with length  $r \leq n$ .*

The proof is not difficult. ■

Now for any partition  $I = i_1, \dots, i_r$  of  $k$ , define a polynomial  $s_I$  in  $k$  variables as follows. Choose  $n \geq k$  so that the elementary symmetric functions  $\sigma_1, \dots, \sigma_k$  of  $t_1, \dots, t_n$  are algebraically independent, and let  $s_I = s_{i_1, \dots, i_r}$  be the unique polynomial satisfying

$$s_I(\sigma_1, \dots, \sigma_k) = \sum t_1^{i_1} \dots t_r^{i_r}.$$

This polynomial does not depend on  $n$ , as one easily verifies by introducing additional variables  $t_{n+1} = \dots = t_n' = 0$ . In fact, even if  $n < k$  the corresponding identity

$$s_I(\sigma_1, \dots, \sigma_n, 0, \dots, 0) = \sum t_1^{i_1} \dots t_r^{i_r}$$

remains valid, as one verifies by a similar argument.

If  $n \geq k$ , then evidently the  $p(k)$  polynomials  $s_I(\sigma_1, \dots, \sigma_k)$  are linearly independent, and form a basis for  $\mathcal{S}^k$ . The first twelve such polynomials are given by

$$\begin{aligned} s(\ ) &= 1, \\ s_1(\sigma_1) &= \sigma_1, \\ \begin{cases} s_2(\sigma_1, \sigma_2) &= \sigma_1^2 - 2\sigma_2 \\ s_{1,1}(\sigma_1, \sigma_2) &= \sigma_2, \end{cases} \\ \begin{cases} s_3(\sigma_1, \sigma_2, \sigma_3) &= \sigma_1^3 - 3\sigma_1\sigma_2 + 3\sigma_3 \\ s_{1,2}(\sigma_1, \sigma_2, \sigma_3) &= \sigma_1\sigma_2 - 3\sigma_3 \end{cases} \\ \begin{cases} s_{1,1,1}(\sigma_1, \sigma_2, \sigma_3) &= \sigma_3, \end{cases} \end{aligned}$$

$$\left\{ \begin{array}{l} s_4 \\ s_{1,3} \\ s_{2,2} \\ s_{1,1,2} \\ s_{1,1,1,1} \end{array} \right. = \begin{array}{l} \sigma_1^4 - 4\sigma_1^2\sigma_2 + 2\sigma_2^2 + 4\sigma_1\sigma_3 - 4\sigma_4 \\ \sigma_1^2\sigma_2 - 2\sigma_2^2 - \sigma_1\sigma_3 + 4\sigma_4 \\ \sigma_2^2 - 2\sigma_1\sigma_3 + 2\sigma_4 \\ \sigma_1\sigma_3 - 4\sigma_4 \\ \sigma_4 \end{array} .$$

For further information see Problem 16-A, as well as [van der Waerden, Chapter 26] particularly the exercises, and [Macmahon].

The application of these ideas to Chern classes or Pontrjagin classes is very similar to the application to Stiefel-Whitney classes in §7. Thus if a complex  $n$ -plane bundle  $\omega$  splits as a Whitney sum  $\eta_1 \oplus \dots \oplus \eta_n$  of line bundles, then the formula

$$1 + c_1(\omega) + \dots + c_n(\omega) = (1+c_1(\eta_1)) \dots (1+c_1(\eta_n))$$

shows that the Chern class  $c_k(\omega)$  can be identified with the  $k$ -th elementary symmetric function  $\sigma_k(c_1(\eta_1), \dots, c_1(\eta_n))$ . The “universal” example of a Whitney sum of line bundles is provided by the  $n$ -fold cartesian product  $\gamma^1 \times \dots \times \gamma^1$  over the product  $P^\infty(\mathbb{C}) \times \dots \times P^\infty(\mathbb{C})$  of complex projective spaces. Note that the cohomology ring of this product is a polynomial ring  $\mathbb{Z}[a_1, \dots, a_n]$  where each  $a_i$  has degree 2, and where

$$c(\gamma^1 \times \dots \times \gamma^1) = (1+a_1) \dots (1+a_n) .$$

Since the elementary symmetric functions are algebraically independent, it follows that the cohomology  $H^*(G_n(\mathbb{C}^\infty); \mathbb{Z})$  of the classifying space maps isomorphically to the ring

$$\mathcal{S}^* \subset \mathbb{Z}[a_1, \dots, a_n]$$

of symmetric polynomials. (This is a theorem of [Borel, 1953]. Compare p. 84.) Thus our new basis for  $\mathcal{S}^*$  gives rise to a new basis

$$\{s_I(c_1, \dots, c_k)\}$$

for the cohomology  $H^{2k}(G_n(\mathbb{C}^\infty); \mathbb{Z})$ .

### A Product Formula

Let  $\omega$  be a complex  $n$ -plane bundle with base space  $B$  and with total Chern class  $c = 1 + c_1 + \dots + c_n$ . For any  $k \geq 0$  and any partition  $I$  of  $k$  the cohomology class

$$s_I(c_1, \dots, c_k) \in H^{2k}(B; \mathbb{Z})$$

will be denoted briefly by the symbol  $s_I(c)$  or  $s_I(c(\omega))$ .

LEMMA 16.2 (Thom). *The characteristic class  $s_I(c(\omega \oplus \omega'))$  of a Whitney sum is equal to*

$$\sum_{JK=I} s_J(c(\omega)) s_K(c(\omega')) ,$$

*to be summed over all partitions  $J$  and  $K$  with juxtaposition  $JK$  equal to  $I$ .*

As an example, since the single element partition of  $k$  can be expressed as a juxtaposition only in two trivial ways, we obtain the following.

COROLLARY 16.3. *The characteristic class  $s_k(c(\omega \oplus \omega'))$  of a Whitney sum is equal to  $s_k(c(\omega)) + s_k(c(\omega'))$ .*

*Proof of 16.2.* Consider a polynomial ring  $\mathbb{Z}[t_1, \dots, t_{2n}]$  in  $2n$  indeterminates, and let  $\sigma_k$  [respectively  $\sigma'_k$ ] be the  $k$ -th elementary symmetric function of the indeterminates  $t_1, \dots, t_n$  [respectively  $t_{n+1}, \dots, t_{2n}$ ]. Then defining

$$\sigma''_k = \sum_{i=0}^k \sigma_i \sigma'_{k-i} ,$$

it is clear that  $\sigma''_k$  is equal to the  $k$ -th elementary symmetric function of  $t_1, \dots, t_{2n}$ . We will verify the identity

$$s_I(\sigma''_1, \dots, \sigma''_k) = \sum_{JK=I} s_J(\sigma_1, \sigma_2, \dots) s_K(\sigma'_1, \sigma'_2, \dots)$$

for any partition  $I = i_1, \dots, i_r$  of  $k$ . Since the classes  $\sigma_1, \dots, \sigma_k, \sigma'_1, \dots, \sigma'_k$  are algebraically independent (assuming as we may that  $k \leq n$ ), this identity together with the product theorem for Chern classes will clearly complete the proof.

By definition, the element

$$s_I(\sigma''_1, \dots, \sigma''_k) \in \mathbb{Z}[t_1, \dots, t_{2n}]$$

is equal to the sum of all monomials which can be written in the form  $t_{a_1}^{i_1} \dots t_{a_r}^{i_r}$ , with  $a_1, \dots, a_r$  distinct numbers between 1 and  $2n$ . For each such monomial let  $J$  [respectively  $K$ ] be the partition formed by those exponents  $i_q$  such that  $1 \leq a_q \leq n$  [respectively  $n + 1 \leq a_q \leq 2n$ ]. The sum of all terms corresponding to a given decomposition  $JK = I$  is clearly equal to

$$s_J(\sigma_1, \sigma_2, \dots) s_K(\sigma'_1, \sigma'_2, \dots) .$$

Since every such decomposition occurs, this completes the proof. ■

Now consider a compact complex manifold  $K^n$  of complex dimension  $n$ . For each partition  $I$  of  $n$  the notation  $s_I(c)[K^n]$ , or briefly  $s_I[K^n]$ , will stand for the characteristic number

$$\langle s_I(c(\tau^n)), \mu_{2n} \rangle \in \mathbb{Z} .$$

This characteristic number is of course equal to a suitable linear combination of Chern numbers.

**COROLLARY 16.4.** *The characteristic number  $s_I[K^m \times L^n]$  of a product of complex manifolds is equal to*

$$\sum_{I_1 I_2 = I} s_{I_1} [K^m] s_{I_2} [L^n] ,$$

to be summed over all partitions  $I_1$  of  $m$  and  $I_2$  of  $n$  with juxtaposition  $I_1 I_2$  equal to  $I$ .

For the tangent bundle of  $K^m \times L^n$  splits as a Whitney sum

$$\tau \times \tau' \cong (\pi_1^* \tau) \oplus (\pi_2^* \tau')$$

where  $\pi_1$  and  $\pi_2$  are the projection maps to the two factors. Hence the characteristic number

$$\langle s_I(\tau \times \tau'), \mu_{2m} \times \mu'_{2n} \rangle$$

is equal to

$$\sum_{I_1 I_2 = I} \langle s_{I_1}(\tau), \mu_{2m} \rangle \langle s_{I_2}(\tau'), \mu'_{2n} \rangle .$$

There are no signs in this formula, since these classes are all even dimensional. ■

As a special case, we clearly have the following.

**COROLLARY 16.5.** *For any product  $K^m \times L^n$  of complex manifolds of dimensions  $m, n \neq 0$ , the characteristic number  $s_{m+n}[K^m \times L^n]$  is zero.*

This corollary suggests the importance of the characteristic number  $s_m[K^m]$ . Here is an example to show that this characteristic number is not always zero.

*Example 16.6.* For the complex projective space  $P^n(\mathbb{C})$ , since  $c(\tau) = (1+a)^{n+1}$  it follows that  $c_k(\tau)$  is equal to the  $k$ -th elementary symmetric function of  $n+1$  copies of  $a$ . Therefore  $s_k(c_1, \dots, c_k)$  is equal to the sum of  $n+1$  copies of  $a^k$ , that is

$$s_k = (n+1)a^k .$$

Taking  $k = n$ , it follows that

$$s_n[P^n(\mathbb{C})] = n + 1 \neq 0 .$$

Thus  $P^n(\mathbb{C})$  cannot be expressed non-trivially as a product of complex manifolds.

Completely analogous formulas are true for Pontrjagin classes and Pontrjagin numbers. If  $\xi$  is a real vector bundle over  $B$ , then for any partition  $I$  of  $n$  the characteristic class

$$s_I(p_1(\xi), \dots, p_n(\xi)) \in H^{4n}(B; \mathbb{Z})$$

is denoted briefly by  $s_I(p(\xi))$ . The congruence

$$s_I(p(\xi \oplus \xi')) \equiv \sum_{JK=I} s_J(p(\xi)) s_K(p(\xi'))$$

modulo elements of order 2 clearly follows from the proof of 16.2. Hence there is a corresponding equality

$$s_I(p)[M \times N] = \sum_{JK=I} s_J(p)[M] s_K(p)[N]$$

for characteristic numbers. In particular, these characteristic numbers of  $M \times N$  are zero unless the dimensions of  $M$  and  $N$  are divisible by 4.

### Linear Independence of Chern Numbers and of Pontrjagin Numbers

The following basic result shows that there are no linear relations between Chern numbers.

**THEOREM 16.7 (Thom).** *Let  $K^1, \dots, K^n$  be complex manifolds with  $s_k(c)[K^k] \neq 0$ . Then the  $p(n) \times p(n)$  matrix*

$$\left[ c_{i_1} \dots c_{i_r} [K^{j_1} \times \dots \times K^{j_s}] \right] ,$$



of Chern numbers, where  $i_1, \dots, i_r$  and  $j_1, \dots, j_s$  range over all partitions of  $n$ , is non-singular.

For example, by 16.6, we can take  $K^r = P^r(\mathbb{C})$ . Similarly:

**THEOREM 16.8 (Thom).** *If  $M^4, \dots, M^{4n}$  are oriented manifolds with  $s_k(p)[M^{4k}] \neq 0$ , then the  $p(n) \times p(n)$  matrix*

$$\left[ p_{i_1} \dots p_{i_r} [M^{4j_1} \times \dots \times M^{4j_s}] \right]$$

of Pontrjagin numbers is non-singular.

Again we can take the complex projective space  $P^{2k}(\mathbb{C})$ , with  $p(r) = (1+a^2)^{2k+1}$  and hence

$$s_k(p)[P^{2k}(\mathbb{C})] = 2k + 1 ,$$

as a suitable manifold  $M^{4k}$ .

Here is an example. For complex dimension 2 taking  $K^n = P^n(\mathbb{C})$  we obtain the matrix

$$\begin{bmatrix} c_1 c_1 [K^1 \times K^1] = 8 & c_1 c_1 [K^2] = 9 \\ c_2 [K^1 \times K^1] = 4 & c_2 [K^2] = 3 \end{bmatrix}$$

of Chern numbers, with determinant  $-12$ . Evidently the direct approach of simply computing the matrix will not help much in the general case.

*Proof of 16.7.* In place of the Chern numbers themselves, we may use the linear combinations  $s_I(c)$ . As an immediate generalization of 16.4 we have

$$s_I[K^{j_1} \times \dots \times K^{j_q}] = \sum_{I_1 \dots I_q = I} s_{I_1}[K^{j_1}] \dots s_{I_q}[K^{j_q}] ,$$

to be summed over all partitions  $I_1$  of  $j_1, I_2$  of  $j_2, \dots$ , and  $I_q$  of  $j_q$  with juxtaposition  $I_1 \dots I_q$  equal to  $I$ . Thus the characteristic number

$s_I[K^{j_1} \times \dots \times K^{j_q}]$  is zero unless the partition  $I = i_1, \dots, i_r$  is a refinement of  $j_1, \dots, j_q$ . In particular it is zero unless  $r \geq q$ . Thus if the partitions  $i_1, \dots, i_r$  and  $j_1, \dots, j_q$  are arranged in a suitably chosen order, then the matrix

$$\left[ s_{i_1, \dots, i_r} [K^{j_1} \times \dots \times K^{j_q}] \right]$$

will be triangular, with zeros everywhere above the diagonal. Each diagonal entry  $s_{i_1, \dots, i_r} [K^{i_1} \times \dots \times K^{i_r}]$  is clearly equal to the product

$$s_{i_1} [K^{i_1}] \dots s_{i_r} [K^{i_r}] \neq 0 .$$

Hence the matrix is non-singular. The proof of 16.8 is completely analogous. ■

Here are some problems for the reader.

*Problem 16-A.* Substituting  $-t_i$  for  $x$  in the identity  $(x+t_1)\dots(x+t_n) = x^n + \sigma_1 x^{n-1} + \dots + \sigma_n$  and then summing over  $i$ , prove Newton's formula

$$s_n - \sigma_1 s_{n-1} + \sigma_2 s_{n-2} - \dots + \sigma_{n-1} s_1 \pm n\sigma_n = 0 .$$

This formula can be used inductively to compute the polynomial  $s_n(\sigma_1, \dots, \sigma_n)$ . Alternatively, taking the logarithm of both sides of the identity  $(1+t_1)\dots(1+t_n) = 1 + (\sigma_1 + \dots + \sigma_n)$ , prove Girard's formula

$$(-1)^k s_k/k = \sum_{i_1+2i_2+\dots+ki_k=k} (-1)^{i_1+\dots+i_k} \frac{(i_1+\dots+i_k-1)!}{i_1! \dots i_k!} \sigma_1^{i_1} \dots \sigma_k^{i_k} .$$

*Problem 16-B.* The Chern character  $ch(\omega)$  of a complex  $n$ -plane bundle  $\omega$  is defined to be the formal sum

$$n + \sum_{k=1}^{\infty} s_k(c(\omega))/k! \in H^{\Pi}(B; \mathbb{Q}) .$$

Show that this Chern character is characterized by additivity

$$\text{ch}(\omega \oplus \omega') = \text{ch}(\omega) + \text{ch}(\omega') ,$$

together with the property that  $\text{ch}(\eta^1)$  is equal to the formal power series  $\exp(c_1(\eta^1))$  for any line bundle  $\eta^1$ . Show that the Chern character is also multiplicative:

$$\text{ch}(\omega \otimes \omega') = \text{ch}(\omega) \text{ch}(\omega') .$$

(As in Problem 7-C, it suffices to consider first the case of two line bundles.)

*Problem 16-C.* If  $2i_1, \dots, 2i_r$  is a partition of  $2k$  into even integers, show that the  $4k$ -dimensional characteristic class  $s_{2i_1, \dots, 2i_r}(c(\omega))$  of a complex vector bundle is equal to the characteristic class  $s_{i_1, \dots, i_r}(p(\omega_R))$  of its underlying real vector bundle. As examples, show that the  $4k$ -dimensional class  $s_{2, \dots, 2}(c(\omega))$  is equal to  $p_k(\omega_R)$ , and show that the characteristic number  $s_{2n}(c)[K^{2n}]$  of a complex  $2n$ -manifold is equal to  $s_n(p)[K^{2n}]$ .

*Problem 16-D.* If the complex manifold  $K^n$  is complex analytically embedded in  $K^{n+1}$  with dual cohomology class  $u \in H^2(K^{n+1}, \mathbb{Z})$ , show that the total tangential Chern class  $c(K^n)$  is equal to the restriction to  $K^n$  of  $c(K^{n+1})/(1+u)$ . For any cohomology class  $x \in H^{2n}(K^{n+1}; \mathbb{Z})$  show that the Kronecker index  $\langle x | K^n, \mu_{2n} \rangle$  is equal to  $\langle xu, \mu_{2n+2} \rangle$ . (Compare p. 120 as well as Problem 11-C.) Using these constructions, compute  $c(K^n)$  for a non-singular algebraic hypersurface  $K^n$  of degree  $d$  in  $P^{n+1}(\mathbb{C})$ , and prove that the characteristic number  $s_n[K^n]$  is equal to  $d(n+2-d^n)$ . (An algebraic hypersurface of degree  $d$  is the set of zeroes of a homogeneous polynomial of degree  $d$ .)

*Problem 16-E.* Similarly, if  $H_{m,n}$  is a non-singular hypersurface of degree  $(1, 1)$  in the product  $P^m(\mathbb{C}) \times P^n(\mathbb{C})$  of complex projective spaces, with  $m, n \geq 2$ , prove that the characteristic number  $s_{m+n-1}[H_{m,n}]$  is equal to  $-(m+n)!/m!n!$ . Using disjoint unions of hypersurfaces, prove

that for each dimension  $n$  there exists a complex manifold  $K^n$  with  $s_n[K^n] = p$  if  $n + 1$  is a power of the prime  $p$ , or with  $s_n[K^n] = 1$  if  $n + 1$  is not a prime power. (A theorem of Milnor and Novikov asserts that these manifolds  $K^1, K^2, K^3, \dots$  freely generate the ring consisting of all “cobordism classes” of manifolds with a complex structure on the stable tangent bundle  $\tau \oplus \varepsilon^k$ . Compare [Stong].)

*Problem 16-F.* Develop a corresponding calculus of mod 2 characteristic numbers  $s_I(w_1, \dots, w_n)[M^n]$ , where  $I$  ranges over partitions of  $n$ . Using real algebraic hypersurfaces of degree  $(1, 1)$  in a product of real projective spaces, prove that there exists a manifold  $Y^n$  with  $s_n(w)[Y^n] \neq 0$  whenever  $n + 1$  is not a power of 2. For  $n$  odd show that  $Y^n$  is orientable. As in Problem 4-E, let  $\mathcal{N}_n$  be the  $\mathbb{Z}/2$  vector space consisting of cobordism classes of unoriented  $n$ -manifolds. Show that the products  $Y^{i_1} \times \dots \times Y^{i_r}$ , where  $i_1, \dots, i_r$  ranges over all partitions of  $n$  into integers not of the form  $2^k - 1$ , are linearly independent in  $\mathcal{N}_n$ . (A theorem of Thom asserts that these products actually form a basis for  $\mathcal{N}_n$ , so that the cobordism algebra  $\mathcal{N}_*$  is a polynomial algebra freely generated by the manifolds  $Y^2, Y^4, Y^5, Y^6, Y^8, \dots$  .

## §17. The Oriented Cobordism Ring $\Omega_*$

In the next two sections we will define and study the Thom cobordism ring  $\Omega_*$ . This section contains the basic definition and some preliminary results. For a fuller treatment of cobordism theory, the reader is referred to [Stong].

### Smooth Manifolds-with-Boundary

Let us first give a precise definition of this concept, which has already been used briefly in §4 and §16. As a universal model for manifolds-with-boundary, we take the closed half-space  $H^n$ , consisting of all points  $(x_1, \dots, x_n)$  in the Euclidean space  $R^n$  with  $x_1 \geq 0$ . A subset  $X \subset R^A$  is called a *smooth n-dimensional manifold-with-boundary* if, for each point  $x \in X$ , there exists a smooth mapping

$$h : U \rightarrow R^A$$

which maps some relatively open set  $U \subset H^n$  homeomorphically onto a neighborhood of  $x$  in  $X$ , and for which the matrix of first derivatives  $[\partial h_\alpha / \partial u_j]$  has rank  $n$  everywhere. (Compare p. 4.)

A point  $x$  of  $X$  is called an *interior point* if there exists such a local parametrization  $h : U \rightarrow R^A$  of  $X$  about  $x$  such that  $U$  is an open subset of  $R^n$  (rather than  $H^n$ ). Evidently the set of interior points forms a smooth  $n$ -dimensional manifold which is open as a subset of  $X$ . The non-interior points form a smooth  $(n-1)$ -dimensional manifold, called the *boundary*  $\partial X$ , which is closed as a subset of  $X$ .

The tangent bundle  $\tau^n$  of a smooth manifold-with-boundary  $X$  is a smooth  $n$ -plane bundle over  $X$ . The definition is completely analogous to that on pp. 6, 14. This  $n$ -plane bundle has some additional structure

which can be described as follows. If  $x$  is a boundary point of  $X$ , then the fiber  $DX_x$  contains an  $(n-1)$ -dimensional subspace  $D(\partial X)_x$  consisting of vectors which are tangent to the boundary. This hyperplane  $D(\partial X)_x$  separates the tangent space  $DX_x$  into two open subsets, consisting respectively of vectors which point "into" or "out of"  $X$ . By definition a vector  $v \in DX_x$ , with  $v \notin D(\partial X)_x$ , points *into*  $X$  if  $v$  is the velocity vector  $(dp/dt)_{t=0}$  of a smooth path

$$p : [0, \varepsilon) \rightarrow X$$

with  $p(0) = x$ . Similarly  $v$  points *out of*  $X$  if  $v$  is the velocity vector at  $t = 0$  of a path  $p : (-\varepsilon, 0] \rightarrow X$  with  $p(0) = x$ .

Now suppose that the tangent bundle  $\tau^n$  of  $X$  is an oriented  $n$ -plane bundle. Then the tangent bundle  $\tau^{n-1}$  of  $\partial X$  has an induced orientation as follows. Choose an oriented basis  $v_1, \dots, v_n$  for  $DX_x$  at any boundary point  $x$  so that  $v_1$  points out of  $X$  and  $v_2, \dots, v_n$  are tangent to  $\partial X$ . Then the ordered basis  $v_2, \dots, v_n$  determines the required orientation for  $D(\partial X)_x$ .

[In the special case of a 1-dimensional manifold-with-boundary, this construction must be modified slightly as follows. An "orientation" of a point  $x$  of the 0-dimensional manifold  $\partial X$  is just a choice of sign  $+1$  or  $-1$ . In fact we assign  $x$  the orientation  $+1$  or  $-1$  according as the positive direction in  $DX_x$  points out of or into  $X$ .]

We will need the following statement.

**COLLAR NEIGHBORHOOD THEOREM 17.1.** *If  $X$  is a smooth paracompact manifold-with-boundary, then there exists an open neighborhood of  $\partial X$  in  $X$  which is diffeomorphic to the product  $\partial X \times [0, 1)$ .*

The proof is similar to that of Theorem 11.1. (Just as for 11.1, we will actually need this assertion only in the special case where  $\partial X$  is compact.) Details will be left to the reader. ■

### Oriented Cobordism

If  $M$  is a smooth oriented manifold, then the notation  $-M$  will be used for the same manifold with opposite orientation. The symbol  $+$  will be used for the disjoint union (also called topological sum) of smooth manifolds.

DEFINITION. Two smooth compact oriented  $n$ -dimensional manifolds  $M$  and  $M'$  are said to be *oriented cobordant*, or to belong to the same *oriented cobordism class*, if there exists a smooth, compact, oriented manifold-with-boundary  $X$  so that  $\partial X$  with its induced orientation is diffeomorphic to  $M + (-M')$  under an orientation preserving diffeomorphism.

LEMMA 17.2. *This relation of oriented cobordism is reflexive, symmetric, and transitive.*

Indeed, the disjoint union  $M + (-M)$  is certainly diffeomorphic to the boundary of  $[0, 1] \times M$  under an orientation preserving diffeomorphism. Furthermore, if  $M + (-M') \cong \partial X$ , then clearly  $M' + (-M) \cong \partial(-X)$ . Finally, if  $M + (-M') \cong \partial X$  and  $M' + (-M'') \cong \partial Y$ , then using 17.1 the smoothness structures and the orientations of  $X$  and  $Y$  can be pieced together along the common boundary  $M'$  so as to yield a new smooth oriented manifold-with-boundary bounded by  $M + (-M'')$ . Details will be left to the reader. ■

Now the set  $\Omega_n$  consisting of all oriented cobordism classes of  $n$ -dimensional manifolds clearly forms an abelian group, using the disjoint union  $+$  as composition operation. The zero element of the group is the cobordism class of the vacuous manifold.

Furthermore the cartesian product operation  $M_1^m, M_2^n \mapsto M_1^m \times M_2^n$  gives rise to an associative, bilinear product operation

$$\Omega_m \times \Omega_n \rightarrow \Omega_{m+n} .$$

Thus the sequence

$$\Omega_* = (\Omega_0, \Omega_1, \Omega_2, \dots)$$

of oriented cobordism groups has the structure of a graded ring. This ring possesses a 2-sided identity element  $1 \in \Omega_0$ . Furthermore, it is easily verified that  $M_1^m \times M_2^n$  is isomorphic as oriented manifold to  $(-1)^{mn} M_2^n \times M_1^m$ . Thus this oriented cobordism ring is commutative in the graded sense.

Pontrjagin numbers provide a basic tool for studying these cobordism groups. As already pointed out in §16, we have the following statement.

LEMMA 17.3 (Pontrjagin). *If  $M^{4k}$  is the boundary of a smooth, compact, oriented  $(4k+1)$ -dimensional manifold-with-boundary, then every Pontrjagin number  $p_{i_1} \dots p_{i_r} [M^{4k}]$  is zero.*

Since the identity  $p_I[M_1 + M_2] = p_I[M_1] + p_I[M_2]$  is clearly satisfied, this proves the following.

COROLLARY 17.4. *For any partition  $I = i_1, \dots, i_r$  of  $k$ , the correspondence  $M^{4k} \mapsto p_I[M^{4k}]$  gives rise to a homomorphism from the cobordism group  $\Omega_{4k}$  to  $\mathbb{Z}$ .*

Now by 16.8 we obtain the following.

COROLLARY 17.5. *The products  $P^{2i_1}(\mathbb{C}) \times \dots \times P^{2i_r}(\mathbb{C})$ , where  $i_1, \dots, i_r$  ranges over all partitions of  $k$ , represent linearly independent elements of the cobordism group  $\Omega_{4k}$ . Hence  $\Omega_{4k}$  has rank greater than or equal to  $p(k)$ , the number of partitions of  $k$ .*

Following Thom, we will prove in §18 that the rank is precisely  $p(k)$ .



To conclude this section, we list without proof the actual structures of the first few oriented cobordism groups. (Compare [Wall, 1960, p. 309].)

$\Omega_0 \cong \mathbb{Z}$ . In fact a compact oriented 0-manifold is just a finite set of signed points, and the sum of the signs is a complete cobordism invariant.

$\Omega_1 = 0$ , since every compact 1-manifold clearly bounds.

$\Omega_2 = 0$ , since a compact *oriented* 2-manifold bounds.

$\Omega_3 = 0$ . In contrast to the lower dimensional cases, this assertion, first announced by [Rohlin], is non-trivial. To our knowledge it has never been proved directly.

$\Omega_4 \cong \mathbb{Z}$ , generated by the complex projective plane  $P^2(\mathbb{C})$ .

$\Omega_5 \cong \mathbb{Z}/2$ , generated by the manifold  $Y^5$  of Problem 16-F.

$\Omega_6 = 0$ .

$\Omega_7 = 0$ .

$\Omega_8 \cong \mathbb{Z} \oplus \mathbb{Z}$ , generated by  $P^4(\mathbb{C})$  and  $P^2(\mathbb{C}) \times P^2(\mathbb{C})$ .

$\Omega_9 \cong (\mathbb{Z}/2) \oplus (\mathbb{Z}/2)$ , generated by  $Y^9$  and the product  $Y^5 \times P^2(\mathbb{C})$ .

$\Omega_{10} \cong \mathbb{Z}/2$ , generated by  $Y^5 \times Y^5$ .

$\Omega_{11} \cong \mathbb{Z}/2$ , generated by  $Y^{11}$ .

As manifold  $Y^5$  (respectively  $Y^9, Y^{11}$ ) we may take the non-singular hypersurface of degree (1, 1) in the product  $P^2 \times P^4$  (respectively  $P^2 \times P^8$  or  $P^4 \times P^8$ ) of real projective spaces. Using products of the generators listed above, it is easy to show that all of the higher cobordism groups are non-zero.

## §18. Thom Spaces and Transversality

This section will describe some of the constructions which are needed to actually compute cobordism groups. We will develop the theory far enough to compute the structure of the ring  $\Omega_*$  modulo torsion.

### The Thom Space of a Euclidean Vector Bundle

Let  $\xi$  be a  $k$ -plane bundle with a Euclidean metric, and let  $A \subset E(\xi)$  be the subset of the total space consisting of all vectors  $v$  with  $|v| \geq 1$ . Then the identification space  $E(\xi)/A$  in which  $A$  is pinched to a point will be called the *Thom space*  $T(\xi)$ . Thus  $T(\xi)$  has a preferred base point, denoted by  $t_0$ , and the complement  $T(\xi) - t_0$  consists of all vectors  $v \in E(\xi)$  with  $|v| < 1$ .

REMARK. If the base space of  $\xi$  is compact, then  $T(\xi)$  can be identified with the single point (Alexandroff) compactification of  $E(\xi)$ . In fact the correspondence  $v \mapsto v/\sqrt{1-|v|^2}$  maps  $E(\xi) - A$  diffeomorphically onto  $E(\xi)$ , inducing the required homeomorphism  $T(\xi) \rightarrow E(\xi) \cup \infty$ .

The following two lemmas describe the topology of  $T(\xi)$ .

LEMMA 18.1. *If the base space  $B$  is a CW-complex, then the Thom space  $T(\xi)$  is a  $(k-1)$ -connected CW-complex, having (in addition to the base point  $t_0$ ) one  $(n+k)$ -cell corresponding to each  $n$ -cell of  $B$ .*

In particular, if  $B$  is a finite complex, then  $T(\xi)$  is a finite complex.

*Proof.* For each open  $n$ -cell  $e_\alpha$  of  $B$ , the inverse image  $\pi^{-1}(e_\alpha) \cap (E-A)$  is an open cell of dimension  $n+k$ ; these open cells are mutually disjoint and cover the set  $E-A \cong T-t_0$ . Note that there are no cells in dimensions 1 through  $k-1$ .

Let  $D^n$  denote the closed unit ball in  $\mathbb{R}^n$  and let  $f: D^n \rightarrow B$  be a characteristic map (p. 73) for the cell  $e_\alpha$ . Then the induced Euclidean vector bundle  $f^*(\xi)$  is trivial by the covering homotopy theorem [Steenrod, §11.6], so the vectors of length  $\leq 1$  in  $E(f^*(\xi))$  form a topological product  $D^n \times D^k$ . The composition

$$D^n \times D^k \subset E(f^*\xi) \rightarrow E(\xi) \rightarrow T(\xi)$$

now forms the required characteristic map for the image of  $\pi^{-1}(e_\alpha)$  in the Thom space  $T(\xi)$ . Further details will be left to the reader. ■

We will need to compute (or at least to estimate) the homotopy groups of such a Thom space  $T(\xi)$ . As a first step, here is a description of the homology.

**LEMMA 18.2.** *If  $\xi$  is an oriented  $k$ -plane bundle over  $B$ , then each integral homology group  $H_{k+i}(T(\xi), t_0)$  is canonically isomorphic to  $H_i(B)$ .*

*Proof.* Evidently the base space  $B$  is embedded as the zero cross-section in the space  $E-A \cong T-t_0$ . Let  $T_0 = E_0/A$  be the complement of the zero section in the Thom space  $T$ . Then evidently  $T_0$  is contractible, so by the exact sequence of the triple  $(T, T_0, t_0)$  it follows that

$$H_n(T, t_0) \cong H_n(T, T_0) .$$

But an easy excision argument shows that

$$H_n(T, t_0) \cong H_n(E, E_0) .$$

Together with the Thom isomorphism

$$H_n(E, E_0) \cong H_{n-k}(B)$$

of §10.7, this completes the proof. ■

### Homotopy Groups Modulo $\mathcal{C}$

In order to relate homology groups to homotopy groups, we use some results of [Serre]. Let  $\mathcal{C}$  denote the class of all finite abelian groups. A homomorphism  $h: A \rightarrow B$  between abelian groups is called a  $\mathcal{C}$ -isomorphism if both the kernel  $h^{-1}(0)$  and the cokernel  $B/h(A)$  belong to  $\mathcal{C}$ .

**THEOREM 18.3.** *Let  $X$  be a finite complex which is  $(k-1)$ -connected,  $k \geq 2$ . Then the Hurewicz homomorphism*

$$\pi_r(X) \rightarrow H_r(X; \mathbb{Z})$$

*is a  $\mathcal{C}$ -isomorphism for  $r < 2k-1$ .*

*Proof.* This Theorem will be established by assembling several results of Serre. First note that the Theorem is true for the special case of a sphere  $S^n$ ,  $n \geq k$ , for the homotopy groups  $\pi_r(S^n)$  are finite for  $r < 2n-1$ ,  $r \neq n$ . (See for example [Spanier, pp. 515-516].)

Next note that it is true for any finite bouquet of spheres. In fact if the Theorem is true for two  $(k-1)$ -connected complexes  $X$  and  $Y$  then, using the Künneth theorem, it is certainly true for the product  $X \times Y$ . Hence, applying the relative Hurewicz theorem to the pair  $(X \times Y, X \vee Y)$ , we see that  $\pi_r(X \vee Y) \cong \pi_r(X \times Y) \cong \pi_r(X) \oplus \pi_r(Y)$  for  $r < 2k-1$ , and it follows easily that the Theorem is true for  $X \vee Y$  also.

Finally, consider an arbitrary  $(k-1)$ -connected finite complex  $X$ . Since the homotopy groups  $\pi_r(X)$  are finitely generated [Spanier, p. 509], we can choose a finite basis for the torsion free part of  $\pi_r(X)$  for each

$r < 2k$ . Represent each basis element by a base point preserving map  $S^{r_i} \rightarrow X$ , and combine these maps to form a single map

$$f : S^{r_1} \vee \dots \vee S^{r_p} \rightarrow X .$$

Since the Theorem has already been established for this bouquet of spheres, we see easily that  $f$  induces a  $\mathcal{C}$ -isomorphism of homotopy groups in dimensions less than  $2k-1$ , and a  $\mathcal{C}$ -surjection in dimension  $2k-1$ . Therefore, by the generalized Whitehead theorem [Spanier, p. 512], it follows that  $f$  also induces a  $\mathcal{C}$ -isomorphism of homology groups in dimensions less than  $2k-1$ . Thus, since the Theorem is true for the bouquet of spheres, it must also be true for  $X$ . ■

*Alternative Proof.* The corresponding statement for cohomotopy groups and cohomology groups is proved in [Serre], hence the present Theorem follows by [Spanier-Whitehead] duality. ■

**COROLLARY 18.4.** *If  $T$  is the Thom space of an oriented  $k$ -plane bundle over the finite complex  $B$ , then there is a  $\mathcal{C}$ -isomorphism*

$$\pi_{n+k}(T) \rightarrow H_n(B; \mathbb{Z})$$

*for all dimensions  $n < k - 1$ .*

*Proof.* This follows immediately from 18.2 and 18.3. ■

Now we must show how to apply this corollary to the computation of cobordism groups.

### Regular Values and Transversality

Let  $M$  and  $N$  be smooth manifolds of dimensions  $m$  and  $n$  respectively, and let  $f : M \rightarrow N$  be a smooth map. A point  $y \in N$  is called a *regular value* of  $f$ , or equivalently the map  $f$  is said to be *transverse* to  $y$ , if for each point  $x \in f^{-1}(y)$  the induced map

$$Df_x : DM_x \rightarrow DN_y$$

of tangent spaces is surjective. [More generally, we say that  $f$  has  $y$  as regular value *throughout* some subset  $X \subset M$  if this condition is satisfied for every  $x \in f^{-1}(y) \cap X$ .] If  $M$  is compact, note that the set of regular values is an open subset of  $N$ .

Of course if the dimension  $m$  is less than  $n$ , then the condition can only be satisfied vacuously: the point  $y \in N$  is a regular value of  $f$  only if  $f^{-1}(y)$  is vacuous. However, if  $m \geq n$ , then the set  $f^{-1}(y)$  may well be non-vacuous.

If  $y$  is a regular value, note that the inverse image  $f^{-1}(y)$  is a (possibly vacuous) smooth manifold of dimension  $m-n$ . This statement follows easily from the Implicit Function Theorem. See for example [Graves, p. 138].

The following extremely useful theorem is due to Arthur B. Brown and (in a sharper version) to Arthur Sard.

**THEOREM OF BROWN.** *Let  $f: W \rightarrow \mathbb{R}^n$  be a smooth (i.e., infinitely differentiable) mapping, where  $W$  is an open subset of  $\mathbb{R}^m$ . Then the set of regular values of  $f$  is everywhere dense in  $\mathbb{R}^n$ .*

Proofs may be found, for example, in [Brown], [Sard], [Sternberg] and [Milnor, 1965].

It follows easily that for any smooth map  $f: M \rightarrow N$ , assuming only that there is a countable basis for the topology of  $M$ , the set of regular values is a countable intersection of dense open sets, and hence is everywhere dense in  $N$ .

Now suppose that we are given a smooth submanifold  $Y \subset N$  of dimension  $n-k$ . A smooth map  $f: M \rightarrow N$  is said to be *transverse* to  $Y$ , if for every  $x \in f^{-1}(Y)$  the composition

$$DM_x \xrightarrow{Df_x} DN_y \longrightarrow DN_y/DY_y$$

from the tangent space at  $x$  to the normal space at  $f(x) = y$  is surjective. [More generally,  $f$  is transverse to  $Y$  throughout some subset  $X$  of  $M$  if this condition is satisfied for every  $x \in X \cap f^{-1}(Y)$ .]

If  $f$  is transverse to  $Y$ , then using the Implicit Function Theorem one verifies that the inverse image  $f^{-1}(Y)$  is a (possibly vacuous) smooth manifold of dimension  $m-k$ .

If  $\nu^k$  is the normal bundle of  $Y$  in  $N$ , then it is not difficult to show that the bundle over  $f^{-1}(Y)$  induced from  $\nu^k$  by  $f$  can be identified with the normal bundle of  $f^{-1}(Y)$  in  $M$ . In particular, if  $\nu^k$  is an oriented vector bundle, and if  $M$  is an oriented manifold, then it follows that  $f^{-1}(Y)$  is an oriented manifold.

In order to actually construct such transversal mappings, we proceed in two steps, starting with the theorem of Brown and Sard. Consider again an open set  $W \subset \mathbb{R}^m$  and consider a smooth map  $f: W \rightarrow \mathbb{R}^k$ . Suppose that  $f$  has the origin as a regular value throughout some relatively closed subset  $X \subset W$ . Let  $K$  be a compact subset of  $W$ .

**LEMMA 18.5.** *There exists a smooth map  $g: W \rightarrow \mathbb{R}^k$  which coincides with  $f$  outside of a compact set, and which has the origin as a regular value throughout  $X \cup K$ . In fact, given  $\varepsilon > 0$ , we can choose  $g$  uniformly close to  $f$  so that  $|f(x) - g(x)| < \varepsilon$  for all  $x$ .*

*Proof.* Using a smooth partition of unity, construct a smooth map  $\lambda: W \rightarrow [0, 1]$  which takes the value 1 on a neighborhood of  $K$  and vanishes outside of a larger compact set  $K' \subset W$ . If  $y$  is any regular value of  $f$ , with  $|y| < \varepsilon$ , then the function  $g$  defined by

$$g(x) = f(x) - \lambda(x)y$$

will certainly:

- (a) have 0 as a regular value throughout  $K$ ,
- (b) coincide with  $f$  outside of  $K'$ , and
- (c) satisfy  $|g(x) - f(x)| < \varepsilon$ .

In fact, by Brown's theorem,  $y$  can be chosen arbitrarily close to the origin 0. If  $y$  is chosen sufficiently close to 0, we claim that  $g$  also has 0 as regular value throughout the intersection  $K' \cap X$ . For by choosing  $|y|$  small, we not only guarantee that  $g$  will be uniformly close to  $f$ , but also that the partial derivatives  $\partial g_i / \partial x_j$  will be uniformly close to the derivatives  $\partial f_i / \partial x_j$ . Therefore, since  $f$  has 0 as regular value throughout the compact set  $K' \cap X$ , it will follow easily that  $g$  also has 0 as regular value throughout  $K' \cap X$ . (See Problem 18-A.) Together with (a) and (b) this implies that  $g$  has 0 as regular value throughout the union  $X \cup K$ , as required. ■

Now let  $\xi$  be a smooth oriented  $k$ -plane bundle. The base space  $B$  of  $\xi$  is smoothly embedded as the zero cross-section in the total space  $E(\xi)$ , and hence in the Thom space  $T = T(\xi)$ .

Given any continuous map  $f$  from the sphere  $S^m$  to the Thom space  $T$ , we would like to first approximate  $f$  by a "smooth" map. This does not quite make sense, since  $T$  is not a manifold. However  $T - t_0$ , the complement of the base point, certainly does have the structure of a smooth manifold, and it is not difficult to approximate  $f$  by a homotopic map  $f_0$  which coincides with  $f$  on  $f^{-1}(t_0) = f_0^{-1}(t_0)$  and is smooth throughout the complement  $f_0^{-1}(T - t_0)$ . The necessary techniques are described, for example, in [Steenrod, §6.7].

**THEOREM 18.6.** *Every continuous map  $f: S^m \rightarrow T(\xi)$  is homotopic to a map  $g$  which is smooth throughout  $g^{-1}(T - t_0)$ , and is transverse to the zero cross-section  $B$ . The oriented cobordism class of the resulting smooth  $(m-k)$ -dimensional manifold  $g^{-1}(B)$  depends only on the homotopy class of  $g$ . Hence the correspondence*



$$g \mapsto g^{-1}(B)$$

gives rise to a homomorphism from the homotopy group  $\pi_m(T, t_0)$  to the oriented cobordism group  $\Omega_{m-k}$ .

*Proof.* As noted above, we can first approximate  $f$  by a map  $f_0$  which is smooth throughout  $f_0^{-1}(T-t_0)$ . Choose a covering of the compact set  $f_0^{-1}(B)$  by open subsets  $W_1, \dots, W_r$  of  $f_0^{-1}(T-t_0)$  which are small enough so that each image

$$f_0(W_i) \subset T-t_0 \subset E(\xi)$$

is contained in some product coordinate patch

$$\pi^{-1}(U_i) \cong U_i \times \mathbb{R}^k$$

for the vector bundle  $\xi$ . Here  $U_i$  denotes an open subset of  $B$  which is small enough so that the bundle  $\xi|_{U_i}$  is trivial.

Choose compact sets  $K_i \subset W_i$  so that  $f_0^{-1}(B)$  is contained in the interior of  $K_1 \cup \dots \cup K_r$ . Then we will modify  $f_0$  within one open set  $W_i$  after another, constructing mappings  $f_1, f_2, \dots, f_r$  satisfying the following three conditions.

- (1) Each  $f_i$  is smooth throughout  $f_i^{-1}(T-t_0) = f_0^{-1}(T-t_0)$ , and coincides with  $f_{i-1}$  outside of a compact subset of  $W_i$ .
- (2) Each  $f_i$  is transverse to  $B$  throughout the set  $K_1 \cup K_2 \cup \dots \cup K_i$ .
- (3) The projection  $\pi(f_i(x)) \in B$  is equal to  $\pi(f_0(x))$  for all  $x \in f_0^{-1}(T-t_0)$ .

Furthermore we will choose each  $f_i$  "close" to  $f_{i-1}$  in a sense to be made precise later. To begin the construction, we assume inductively that a map  $f_{i-1}$  has been chosen so as to satisfy (1), (2), and (3). It follows from Condition (3) that  $f_{i-1}$  must map the open set  $W_i$  into the product coordinate patch  $\pi^{-1}(U_i)$ . Using the product structure

$$\pi^{-1}(U_i) \cong U_i \times \mathbb{R}^k,$$

let  $\rho_i: \pi^{-1}(U_i) \rightarrow \mathbb{R}^k$  be the projection map to the second factor. We want to choose a new map  $x \mapsto f_i(x)$  for  $x \in W_i$ . The first coordinate  $\pi(f_i(x))$  is already determined by (3), so we need only choose the second coordinate  $\rho_i(f_i(x))$ .

Since  $f_{i-1}$  satisfies Condition (2), it follows easily that the composition  $x \mapsto \rho_i(f_{i-1}(x))$  has the origin of  $\mathbb{R}^k$  as a regular value throughout the relatively closed subset  $(K_1 \cup \dots \cup K_{i-1}) \cap W_i$  of  $W_i$ . Hence, by 18.5, we can approximate this composition by a map from  $W_i$  to  $\mathbb{R}^k$  which

(a) agrees with  $\rho_i \circ f_{i-1}$  outside of a compact subset of  $W_i$ , and

(b) has the origin as regular value throughout  $(K_1 \cup \dots \cup K_i) \cap W_i$ .

Taking this approximating map to be  $\rho_i \circ f_i$ , we have evidently, in view of Conditions (1) and (3), defined  $f_i(x)$  for all  $x$ . Furthermore, it is clear that this new map  $f_i$  will satisfy Condition (2).

Thus, proceeding by induction, we can construct maps  $f_1, f_2, \dots, f_r$ , all satisfying the Conditions (1), (2), (3). Let  $g = f_r$ . Clearly  $g$  is transverse to  $B$  throughout the compact set  $K_1 \cup \dots \cup K_r$ . If we can guarantee that the entire inverse image  $g^{-1}(B)$  is contained in  $K_1 \cup \dots \cup K_r$ , then we will be sure that  $g$  is transverse to  $B$  everywhere, as required.

For each  $t \in T - t_0 \cong E - A$  let  $0 \leq |t| < 1$  denote the Euclidean norm, so that  $|t| = 0$  if and only if  $t \in B$ . It is convenient to set  $|t_0| = 1$ . Since  $K_1 \cup \dots \cup K_r$  is a neighborhood of  $f_0^{-1}(B)$  in the compact space  $S^m$ , there exists a constant  $c > 0$  so that

$$|f_0(x)| \geq c$$

for all  $x \notin K_1 \cup \dots \cup K_r$ . Suppose that each  $f_i$  is chosen so close to  $f_{i-1}$  that

$$|f_i(x) - f_{i-1}(x)| < c/r$$

for all  $x$ . Then evidently

$$|g(x) - f_0(x)| < c.$$

Therefore  $|g(x)| \neq 0$  for  $x \notin K_1 \cup \dots \cup K_r$ , and the entire inverse image  $g^{-1}(B)$  must be contained in  $K_1 \cup \dots \cup K_r$ . Hence  $g$  is transverse to  $B$  everywhere, and the inverse image  $g^{-1}(B)$  is a smooth, compact, oriented  $(m-k)$ -dimensional manifold. This proves the first part of 18.6.

Next consider two homotopic maps  $g$  and  $g'$  from  $S^m$  to  $T$ , both being smooth on the inverse image of  $T-t_0$  and both being transverse to  $B$ . Then it is not difficult to construct a homotopy

$$h_0 : S^m \times [0, 3] \rightarrow T$$

which is smooth throughout  $h_0^{-1}(T-t_0)$ , and which satisfies

$$\begin{aligned} h_0(x, t) &= g(x) & \text{for } t \in [0, 1] , \\ h_0(x, t) &= g'(x) & \text{for } t \in [2, 3] . \end{aligned}$$

Proceeding as above, we can then construct a new map  $h : S^m \times [0, 3] \rightarrow T$  which coincides with  $h_0$  except on a compact subset of  $S^m \times (0, 3)$ , and which is transverse to  $B$ . The construction is inductive, making sure at each stage that transversality throughout the set  $S^m \times [0, 1] \cup S^m \times [2, 3]$  is not lost. The inverse image  $h^{-1}(B)$  under this new homotopy will then provide the required oriented cobordism between  $g^{-1}(B)$  and  $g'^{-1}(B)$ . *Thus the oriented cobordism class of  $g^{-1}(B)$  depends only on the homotopy class of  $B$ .*

Since the composition operation in the homotopy group  $\pi_m(T, t_0)$  clearly corresponds to the disjoint union operation for the manifolds  $g^{-1}(B)$ , it follows that this correspondence  $g \mapsto g^{-1}(B)$  gives rise to a well defined homomorphism from  $\pi_m(T, t_0)$  to the cobordism group  $\Omega_{m-k}$ . ■

### The Main Theorem

In place of the smooth oriented  $k$ -plane bundle of 18.6, let us substitute the universal oriented  $k$ -plane bundle  $\tilde{\gamma}^k$  over  $\tilde{G}_k(\mathbb{R}^\infty)$ . The following result lies at the heart of Thom's theory.

THEOREM OF THOM. For  $k > n+1$  the homotopy group  $\pi_{n+k}(T(\tilde{\gamma}^k), t_0)$  of the universal Thom space is canonically isomorphic to the oriented cobordism group  $\Omega_n$ . Similarly the homotopy group  $\pi_{n+k}(T(\gamma^k), t_0)$  associated with the unoriented universal bundle is canonically isomorphic to the unoriented cobordism group  $\mathcal{N}_n$ .

REMARK. Thom uses the notations  $MSO(k)$  and  $MO(k)$  for these two universal Thom spaces. These correspond to the standard notations  $BSO(k)$  and  $BO(k)$  for the associated universal base spaces.

To simplify our discussion, we will not prove all of Thom's theorem, but only the following partial statement. Let  $\tilde{\gamma}_p^k = \tilde{\gamma}^k(\mathbb{R}^{k+p})$  be the bundle of oriented  $k$ -planes in  $(k+p)$ -space.

LEMMA 18.7. If  $k \geq n$  and  $p \geq n$ , then the homomorphism

$$\pi_{n+k}(T(\tilde{\gamma}_p^k)) \rightarrow \Omega_n$$

of 18.6 is surjective.

*Proof.* Let  $M^n$  be an arbitrary smooth, compact, oriented  $n$ -dimensional manifold. Then, by a theorem of [Whitney, 1944],  $M^n$  can be embedded in the Euclidean space  $\mathbb{R}^{n+k}$ . Proceeding as in §11.1, we can choose a neighborhood  $U$  of  $M^n$  in  $\mathbb{R}^{n+k}$  which is diffeomorphic to the total space  $E(\nu^k)$  of the normal bundle. Using the Gauss map, we have

$$U \cong E(\nu^k) \rightarrow E(\tilde{\gamma}_n^k) \subset E(\tilde{\gamma}_p^k),$$

and composing with the canonical map  $E(\tilde{\gamma}_p^k) \rightarrow T(\tilde{\gamma}_p^k)$ , we obtain a map  $g: U \rightarrow T(\tilde{\gamma}_p^k)$  which is transverse to the zero cross-section  $B$ , and satisfies  $g^{-1}(B) = M^n$ .

Now extend  $g$  to the one point compactification  $\mathbb{R}^{n+k} \cup \infty \cong S^{n+k}$  by mapping  $S^{n+k} - U$  to the base point  $t_0$ . The resulting map

$\hat{g}: S^{n+k} \rightarrow T(\tilde{\gamma}_p^k)$  clearly gives rise, under the construction of 18.6, to the cobordism class of  $M^n$ . ■

We are now ready to prove our main result.

**THEOREM 18.8 (Thom).** *The oriented cobordism group  $\Omega_n$  is finite for  $n \not\equiv 0 \pmod{4}$ , and is a finitely generated group with rank equal to  $p(r)$ , the number of partitions of  $r$ , when  $n = 4r$ .*

For by 18.7 the group  $\Omega_n$  is a homomorphic image of  $\pi_{n+k}(T(\tilde{\gamma}_p^k))$  for  $k$  and  $p$  large, and by 18.4 this latter group is  $\mathbb{C}$ -isomorphic to  $H_n(\tilde{G}_k(\mathbb{R}^{k+p}); \mathbb{Z})$ . But using §15.9, the group  $H_n(\tilde{G}_k(\mathbb{R}^{k+p}); \mathbb{Z})$  is finite for  $n \not\equiv 0 \pmod{4}$ , and is finitely generated of rank  $p(r)$  for  $n = 4r$ . Therefore  $\Omega_n$  is finite for  $n \not\equiv 0 \pmod{4}$ , and  $\Omega_{4r}$  is finitely generated with

$$\text{rank}(\Omega_{4r}) \leq p(r) .$$

Since  $\text{rank}(\Omega_{4r}) \geq p(r)$  by §17.5, the conclusion follows. ■

If we kill torsion by tensoring the cobordism ring  $\Omega_*$  with the rational numbers  $\mathbb{Q}$ , then evidently the products

$$P^{2i_1}(\mathbb{C}) \times \dots \times P^{2i_r}(\mathbb{C}) ,$$

where  $i_1, \dots, i_r$  ranges over all partitions of  $k$ , will be linearly independent, and hence will form a basis for the vector space  $\Omega_{4k} \otimes \mathbb{Q}$ . (Compare 17.5.) This proves the following.

**COROLLARY 18.9.** *The tensor product  $\Omega_* \otimes \mathbb{Q}$  is a polynomial algebra over  $\mathbb{Q}$  with independent generators  $P^2(\mathbb{C}), P^4(\mathbb{C}), P^6(\mathbb{C}), \dots$ .*

Another immediate consequence is the following.

**COROLLARY 18.10.** *Let  $M^n$  be smooth, compact and oriented. Then some positive multiple  $M^n + \dots + M^n$  is an oriented boundary if and only if every Pontrjagin number  $p_1[M^n]$  is zero.*

For otherwise there would be too many linearly independent elements in  $\Omega_n$ . ■

[C. T. C. Wall] has proved the following much sharper statement. *The manifold  $M^n$  itself is an oriented boundary if and only if all Pontrjagin numbers and all Stiefel-Whitney numbers of  $M^n$  are zero.* Thus the cobordism group  $\Omega_n$  is always the direct sum of a number of copies of  $\mathbb{Z}/2$  and (if  $n \equiv 0 \pmod{4}$ ) a number of copies of  $\mathbb{Z}$ .

We conclude with a problem for the reader.

**Problem 18-A.** As in the proof of 18.5, suppose that  $f$  has the origin as regular value throughout a compact set  $K'' \subset W \subset \mathbb{R}^m$ . If  $g$  is uniformly close to  $f$  and the derivatives  $\partial g_i / \partial x_j$  are uniformly close to the  $\partial f_i / \partial x_j$ , show that  $g$  has the origin as regular value throughout  $K''$ .

## §19. Multiplicative Sequences and the Signature Theorem

The material in this chapter is due to [Hirzebruch].

Let  $\Lambda$  be a fixed commutative ring with unit (usually the ring of rational numbers). The symbol

$$A^* = (A^0, A^1, A^2, \dots)$$

will stand for a graded  $\Lambda$ -algebra with unit which is commutative in the classical sense ( $xy = yx$  regardless of the degrees of  $x$  and  $y$ ). In the main application,  $A^n$  will be the cohomology group  $H^{4n}(B; \Lambda)$ .

To each such  $A^*$  we associate the commutative ring  $A^\Pi$  consisting of all formal sums  $a_0 + a_1 + a_2 + \dots$  with  $a_i \in A^i$ . (Compare p. 39.) We will be particularly interested in the group consisting of all elements of the form

$$a = 1 + a_1 + a_2 + \dots$$

in  $A^\Pi$ . The product of two such units is evidently given by the formula

$$(1 + a_1 + a_2 + \dots)(1 + b_1 + b_2 + \dots) = 1 + (a_1 + b_1) + (a_2 + a_1 b_1 + b_2) + \dots$$

Now consider a sequence of polynomials

$$K_1(x_1), K_2(x_1, x_2), K_3(x_1, x_2, x_3), \dots$$

with coefficients in  $\Lambda$  such that, if the variable  $x_i$  is assigned degree  $i$ , then

(1) *each  $K_n(x_1, \dots, x_n)$  is homogeneous of degree  $n$ .*

Given  $A^\Pi$  as above, and an element  $a \in A^\Pi$  with leading term 1, define a new element  $K(a) \in A^\Pi$ , also with leading term 1, by the formula

$$K(a) = 1 + K_1(a_1) + K_2(a_1, a_2) + \dots$$

DEFINITION. The  $K_n$  form a *multiplicative sequence* of polynomials if the identity

$$(2) K(ab) = K(a)K(b)$$

is satisfied for all such  $\Lambda$ -algebras  $A^*$  and for all  $a, b \in A^{\Pi}$  with leading term 1.

*Example 1.* Given any constant  $\lambda \in \Lambda$  the polynomials

$$K_n(x_1, \dots, x_n) = \lambda^n x_n$$

form a multiplicative sequence, with

$$K(1 + a_1 + a_2 + \dots) = 1 + \lambda a_1 + \lambda^2 a_2 + \dots .$$

The cases  $\lambda = 1$  (so that  $K(a) = a$ ) and  $\lambda = -1$  (compare §14.9) are of particular interest.

*Example 2.* The identity  $K(a) = a^{-1}$  defines a multiplicative sequence with

$$K_1(x_1) = -x_1$$

$$K_2(x_1, x_2) = x_1^2 - x_2$$

$$K_3(x_1, x_2, x_3) = -x_1^3 + 2x_1x_2 - x_3$$

$$K_4(x_1, x_2, x_3, x_4) = x_1^4 - 3x_1^2x_2 + 2x_1x_3 + x_2^2 - x_4 ,$$

and in general

$$K_n = \sum_{i_1 + 2i_2 + \dots + ni_n = n} \frac{(i_1 + \dots + i_n)!}{i_1! \dots i_n!} (-x_1)^{i_1} \dots (-x_n)^{i_n} .$$

These polynomials can be used to describe the relations between the Pontrjagin classes (or the Chern classes, or the Stiefel-Whitney classes) of two vector bundles with trivial Whitney sum. Compare pp. 39-41.



EXAMPLE 3. The polynomials  $K_{2n+1} = 0$  and  $K_{2n}(x_1, \dots, x_{2n}) = x_n^2 - 2x_{n-1}x_{n+1} + \dots \mp 2x_1x_{2n-1} \pm 2x_n$  form a multiplicative sequence which can be used to describe the relationship between the Chern classes of a complex vector bundle  $\omega$  and the Pontrjagin classes of the underlying real bundle  $\omega_{\mathbb{R}}$ . Compare §15.5.

The following theorem gives a simple classification of all possible multiplicative sequences. Let  $A^*$  be the graded polynomial ring  $\Lambda[t]$  where  $t$  is an indeterminate of degree 1. Then an element of  $A^{\Pi}$  with leading term 1 can be thought of as a formal power series

$$f(t) = 1 + \lambda_1 t + \lambda_2 t^2 + \lambda_3 t^3 + \dots$$

with coefficients in  $\Lambda$ . In particular  $1 + t$  is such an element.

LEMMA 19.1 (Hirzebruch). *Given a formal power series  $f(t) = 1 + \lambda_1 t + \lambda_2 t^2 + \dots$  with coefficients in  $\Lambda$ , there is one and only one multiplicative sequence  $\{K_n\}$  with coefficients in  $\Lambda$  satisfying the condition*

$$K(1+t) = f(t) ,$$

*or equivalently satisfying the condition that the coefficient of  $x_1^n$  in each polynomial  $K_n(x_1, \dots, x_n)$  is equal to  $\lambda_n$ .*

DEFINITION.  $\{K_n\}$  is called the multiplicative sequence *belonging* to the power series  $f(t)$ .

*Examples.* The three multiplicative sequences mentioned above belong to the power series  $1 + \lambda t$ ,  $1 - t + t^2 - t^3 + \dots$ , and  $1 + t^2$  respectively.

REMARK. If the multiplicative sequence  $\{K_n\}$  belongs to the power series  $f(t)$ , then for any  $A^*$  and any  $a_1 \in A^1$  the identity

$$K(1+a_1) = f(a_1)$$

is satisfied. Of course this identity would no longer be true if something of degree  $\neq 1$  were substituted in place of  $a_1$ .

*Proof of uniqueness.* Choosing any positive integer  $n$ , let  $A^*$  be the polynomial ring  $\Lambda[t_1, \dots, t_n]$  where the  $t_i$  are algebraically independent of degree 1, and let

$$\sigma = (1+t_1) \dots (1+t_n) \in A^{\Pi} .$$

Then

$$K(\sigma) = K(1+t_1) \dots K(1+t_n) = f(t_1) \dots f(t_n) .$$

Taking the homogeneous part of degree  $n$ , it follows that  $K_n(\sigma_1, \dots, \sigma_n)$  is completely determined by the power series  $f(t)$ . Since the elementary symmetric functions  $\sigma_1, \dots, \sigma_n$  are algebraically independent, this proves the uniqueness of each  $K_n$ .

*Proof of existence.* For any partition  $I = i_1, \dots, i_r$  of  $n$ , it will be convenient to use the abbreviation  $\lambda_I$  for the product  $\lambda_{i_1} \dots \lambda_{i_r}$ . With this convention, let us define the polynomial  $K_n$  by the formula

$$K_n(\sigma_1, \sigma_2, \dots, \sigma_n) = \sum \lambda_I s_I(\sigma_1, \dots, \sigma_n) ,$$

to be summed over all partitions  $I$  of  $n$ . Here  $s_I$  stands for the polynomial of §16.1, with  $s_I(\sigma_1, \dots, \sigma_n) = \sum t_1^{i_1} \dots t_r^{i_r}$ .

Just as in §16.2, we have the identity

$$s_I(ab) = \sum_{HJ=I} s_H(a) s_J(b) ,$$

to be summed over all partitions  $H$  and  $J$  with juxtaposition  $HJ$  equal to  $I$ . Therefore

$$K(ab) = \sum_I \lambda_I s_I(ab)$$

is equal to

$$\sum_I \lambda_I \sum_{HJ=I} s_H(a) s_J(b) = \sum_{H,J} \lambda_H s_H(a) \lambda_J s_J(b) .$$

Evidently this equals  $K(a)K(b)$  as required. ■

Now consider some multiplicative sequence of polynomials  $\{K_n(x_1, \dots, x_n)\}$  with rational coefficients. Let  $M^m$  be a smooth, compact, oriented  $m$ -dimensional manifold.

DEFINITION. The  $K$ -genus  $K[M^m]$  is zero if the dimension  $m$  is not divisible by 4, and is equal to the rational number

$$K_n[M^{4n}] = \langle K_n(p_1, \dots, p_n), \mu_{4n} \rangle$$

if  $m = 4n$ , where  $p_i$  denotes the  $i$ -th Pontrjagin class of the tangent bundle. Thus  $K[M^m]$  is a certain rational linear combination of the Pontrjagin numbers of  $M^m$ .

LEMMA 19.2. For any multiplicative sequence  $\{K_n\}$ , with rational coefficients, the correspondence  $M \mapsto K[M]$  defines a ring homomorphism from the cobordism ring  $\Omega_*$  to the rational numbers  $\mathbb{Q}$ .

Equivalently, this correspondence gives rise to an algebra homomorphism from  $\Omega_* \otimes \mathbb{Q}$  to  $\mathbb{Q}$ .

*Proof.* It is clear that the correspondence is additive, and that the  $K$ -genus of a boundary is zero. For a product manifold  $M \times M'$ , with total Pontrjagin class congruent to  $p \times p'$  modulo elements of order 2, we have  $K(p \times p') = K(p) \times K(p')$ , hence

$$\langle K(p \times p'), \mu \times \mu' \rangle = (-1)^{mm'} \langle K(p), \mu \rangle \langle K(p'), \mu' \rangle .$$

Since the sign in this formula is certainly  $+1$  when the dimensions  $m, m'$  are divisible by 4, this proves that

$$K[M \times M'] = K[M] K[M']$$

as required. ■

We will use this construction to compute an important homotopy type invariant of  $M$ .

DEFINITION. The *signature*  $\sigma$  of a compact, oriented manifold  $M^m$  is defined to be zero if the dimension is not a multiple of 4, and as follows for  $m = 4k$ . Choose a basis  $a_1, \dots, a_r$  for  $H^{2k}(M^{4k}; \mathbb{Q})$  so that the symmetric matrix

$$[\langle a_i \cup a_j, \mu \rangle]$$

is diagonal. Then  $\sigma(M^{4k})$  is the number of positive diagonal entries minus the number of negative ones. (In other words  $\sigma$  is the signature of the rational quadratic form  $a \mapsto \langle a \cup a, \mu \rangle$ .)

Alternatively, this number  $\sigma$  is often called the "index" of  $M$ , particularly in the older literature.

LEMMA 19.3 (Thom). *This signature function has the following three properties:*

- (1)  $\sigma(M + M') = \sigma(M) + \sigma(M')$ ,
- (2)  $\sigma(M \times M') = \sigma(M)\sigma(M')$ ,
- (3) if  $M$  is an oriented boundary, then  $\sigma(M) = 0$ .

In fact Assertion (1) is trivial, (2) can be proved using the Künneth isomorphism  $H^*(M \times M'; \mathbb{Q}) \cong H^*(M; \mathbb{Q}) \otimes H^*(M'; \mathbb{Q})$ , and (3) can be proved using the Poincaré duality theorem for manifolds with boundary. Details may be found in [Hirzebruch, §8], or in [Stong, pp. 220-222]. ■

It follows immediately from properties (1) and (3) that the signature of a manifold can be expressed as a linear function of its Pontrjagin numbers. More precisely, according to Hirzebruch, one has the following.

SIGNATURE THEOREM 19.4. *Let  $\{L_k(p_1, \dots, p_k)\}$  be the multiplicative sequence of polynomials belonging to the power series*

$$\sqrt{t}/\tanh \sqrt{t} = 1 + \frac{1}{3}t - \frac{1}{45}t^2 + \dots + (-1)^{k-1} 2^{2k} B_k t^k / (2k)! \dots$$

*Then the signature  $\sigma(M^{4k})$  of any smooth compact oriented manifold  $M^{4k}$  is equal to the L-genus  $L[M^{4k}]$ .*

Here  $B_k$  denotes the  $k$ -th Bernoulli number (compare Appendix B), with

$$B_1 = 1/6, \quad B_2 = 1/30, \quad B_3 = 1/42, \dots$$

The first four  $L$ -polynomials are

$$L_1 = \frac{1}{3} p_1$$

$$L_2 = \frac{1}{45} (7p_2 - p_1^2)$$

$$L_3 = \frac{1}{945} (62p_3 - 13p_2p_1 + 2p_1^3)$$

$$L_4 = \frac{1}{14175} (381p_4 - 71p_3p_1 - 19p_2^2 + 22p_2p_1^2 - 3p_1^4) .$$

*Proof of the Signature Theorem.* Since the correspondences  $M \mapsto \sigma(M)$  and  $M \mapsto L[M]$  both give rise to algebra homomorphisms from  $\Omega_* \otimes \mathbb{Q}$  to  $\mathbb{Q}$ , it suffices to check this theorem on a set of generators for the algebra  $\Omega_* \otimes \mathbb{Q}$ . According to §18.9, the complex projective spaces  $P^{2k}(\mathbb{C})$  provide such a set of generators.

To compute the signature of  $P^{2k}(\mathbb{C})$ , we need only note that  $H^{2k}(P^{2k}(\mathbb{C}); \mathbb{Q})$  is generated by a single element  $a^k$  with

$$\langle a^k \cup a^k, \mu \rangle = 1 .$$

(Compare 14.4, 14.10.) Hence the signature  $\sigma(P^{2k}(\mathbb{C}))$  is  $+1$ .

To compute  $L_k[P^{2k}(\mathbb{C})]$ , we recall from §15.6 that the tangential Pontrjagin class  $p$  of  $P^{2k}(\mathbb{C})$  is equal to  $(1+a^2)^{2k+1}$ . Since the multiplicative sequence  $\{L_k\}$  belongs to the power series  $f(t) = \sqrt{t}/\tanh \sqrt{t}$ , it follows that

$$L(1+a^2+0+\dots) = \sqrt{a^2}/\tanh \sqrt{a^2} ,$$

and hence that

$$L(p) = (a/\tanh a)^{2k+1} .$$

Thus the  $L$ -genus  $\langle L(p), \mu \rangle$  is equal to the coefficient of  $a^{2k}$  in this power series.

Replacing  $a$  by the complex variable  $z$ , the coefficient of  $z^{2k}$  in the Taylor expansion of  $(z/\tanh z)^{2k+1}$  can be computed by dividing by  $2\pi iz^{2k+1}$  and then integrating around the origin. In fact the substitution  $u = \tanh z$ , with

$$dz = \frac{du}{1-u^2} = (1+u^2+u^4+\dots)du,$$

shows that

$$\frac{1}{2\pi i} \oint \frac{dz}{(\tanh z)^{2k+1}} = \frac{1}{2\pi i} \oint \frac{(1+u^2+u^4+\dots)du}{u^{2k+1}}$$

is equal to  $+1$ . Hence  $L[P^{2k}(\mathbb{C})]$  is equal to  $+1 = \sigma(P^{2k}(\mathbb{C}))$ , and it follows that  $L[M] = \sigma(M)$  for all  $M$ . ■

A more direct proof of the signature theorem has been given by [Atiyah and Singer, §6], as an application of the "Index Theorem" for elliptic differential operators.

**COROLLARY 19.5.** *The L-genus of any manifold is an integer.*

For the signature  $\sigma$  is always an integer. ■

It follows, for example, that the Pontrjagin number  $p_1[M^4]$  is divisible by 3, and the number  $7p_2[M^8] - p_1^2[M^8]$  is divisible by 45.

**COROLLARY 19.6.** *The L-genus  $L[M]$  depends only on the oriented homotopy type of  $M$ .*

For  $\sigma(M)$  is clearly invariant under any orientation preserving homotopy equivalence. ■

According to [Kahn], the L-genus and its rational multiples are the only rational linear combinations of Pontrjagin numbers which are oriented homotopy type invariants.

### Multiplicative Characteristic Classes

For the remainder of this section we will very briefly describe another application of multiplicative sequences. Let  $\Lambda$  be an integral domain containing  $1/2$ , and let  $\{K_n\}$  be a multiplicative sequence with coefficients in  $\Lambda$ . Setting

$$k_n(\xi) = K_n(p_1(\xi), \dots, p_n(\xi))$$

for any real vector bundle  $\xi$ , we clearly obtain a sequence of “characteristic classes”

$$k_n(\xi) \in H^{4n}(B; \Lambda)$$

which are natural with respect to bundle maps, and satisfy the product formula

$$k_n(\xi \oplus \eta) = \sum_{i+j=n} k_i(\xi) k_j(\eta) .$$

Here it is understood that  $k_0(\xi) = 1$ . [Setting  $k(\xi) = \sum k_i(\xi)$ , we can of course write this product formula briefly as  $k(\xi \oplus \eta) = k(\xi)k(\eta)$ .]

Conversely, given a sequence of characteristic classes  $k_n(\xi)$  satisfying these properties, it is not difficult to show that  $k_n(\xi) = K_n(p_1(\xi), \dots, p_n(\xi))$  for some uniquely defined multiplicative sequence  $\{K_n\}$ . (Compare §15.9 and Problem 15-B.) It does not matter whether or not the bundles  $\xi$  are required to be oriented or orientable.

The precise multiplicative sequence corresponding to a given sequence  $\{k_n(\xi)\}$  of characteristic classes can be identified as follows. Let  $\gamma^1$  be the canonical complex line bundle over  $P^\infty(\mathbb{C})$ , and recall that

$$p_1(\gamma^1_{\mathbb{R}}) = a^2 \in H^4(P^\infty(\mathbb{C}); \mathbb{Z}) .$$

(Compare 14.4, 14.10, and 15.5.) Defining a formal power series  $f(t)$  by setting  $f(a^2)$  equal to  $k(\gamma^1_{\mathbb{R}}) = \sum k_n(\gamma^1_{\mathbb{R}})$ , it clearly follows that  $\{K_n\}$  is the multiplicative sequence belonging to this power series  $f(t)$ .

To illustrate these ideas, let us consider the case  $\Lambda = \mathbb{Z}/\ell$  where  $\ell$  is a fixed odd prime. Let

$$\mathcal{P}^k : H^i(X; \mathbb{Z}/\ell) \rightarrow H^{i+4rk}(X; \mathbb{Z}/\ell)$$

denote the Steenrod reduced  $\ell$ -th power operation, where  $r = \frac{1}{2}(\ell-1)$ . (Compare [Steenrod and Epstein].) Following [Wu, 1955], and in analogy with Thom's definition of Stiefel-Whitney classes (§8), we define a new characteristic class

$$q_n(\xi) \in H^{4rn}(B; \mathbb{Z}/\ell)$$

by the identity  $q_n(\xi) = \phi^{-1} \mathcal{P}^n \phi(1)$  for any oriented vector bundle  $\xi$ . Just as in §8, it is easy to check that the  $q_n$  are natural, and satisfy a product formula. Hence

$$q_n(\xi) = K_{rn}(p_1(\xi), \dots, p_{rn}(\xi))$$

for some uniquely determined multiplicative sequence  $\{K_i\}$  with mod  $\ell$  coefficients.

To identify this multiplicative sequence, we need only consider the particular vector bundle  $\xi = \gamma^1_{\mathbb{R}}$  over the infinite complex projective space  $P^\infty(\mathbb{C})$ . The space  $E_0$  of non-zero vectors in  $E = E(\gamma^1_{\mathbb{R}})$  has the homology of a point. Hence there are natural ring isomorphisms

$$H^*(E, E_0) \cong H^*(E, \text{point}) \cong H^*(P^\infty(\mathbb{C}), \text{point}) .$$

The fundamental cohomology class  $u \in H^2(E, E_0)$  corresponds to the class

$$e(\gamma^1_{\mathbb{R}}) = c_1(\gamma^1) = -a \in H^2(P^\infty(\mathbb{C})) .$$

(See 14.10.) Therefore the element  $\mathcal{P}^1(u) = u^\ell$  (see [Steenrod-Epstein, p. 76]) corresponds to  $(-a)^\ell$ , and it follows that

$$q_1(\gamma^1_{\mathbb{R}}) = (-a)^{\ell-1} = a^{2r} .$$

Since the higher  $\mathcal{P}^k(u)$  are zero for dimensional reasons, this shows that the formal power series  $f(a^2) = \sum q_k(\gamma^1_{\mathbb{R}})$  is equal to  $1 + a^{2r}$ , which proves the following.



THEOREM 19.7 (Wu). *If  $\ell = 2r + 1$  is an odd prime, then the mod  $\ell$  characteristic class*

$$q_n(\xi) = \phi^{-1} \mathcal{P}^n \phi(1)$$

*is equal to  $K_{rn}(p_1(\xi), \dots, p_{rn}(\xi))$  where  $\{K_i\}$  is the multiplicative sequence belonging to the power series  $f(t) = 1 + t^r$ .*

As examples, for  $\ell = 3$  it follows that  $q_n(\xi)$  is equal to the Pontrjagin class  $p_n(\xi)$  reduced modulo 3, and for  $\ell = 5$  it follows that  $q_n(\xi)$  is equal to  $p_n^2 - 2p_{n-1}p_{n+1} + \dots \pm 2p_{2n}$  reduced modulo 5.

Just as in the mod 2 case, it can be shown that  $q_i(r^n)$ , for the tangent bundle  $r^n$  of a compact oriented manifold, is a homotopy type invariant. (Compare §11.14.) In fact

$$q_i = v_i + \mathcal{P}^1 v_{i-1} + \mathcal{P}^2 v_{i-2} + \dots$$

where the Wu class  $v_i$  is characterized by the identity

$$\langle \mathcal{P}^i x, \mu \rangle = \langle x \cup v_i, \mu \rangle$$

for all  $x \in H^{n-4ri}(M^n; \mathbb{Z}/\ell)$ . In particular, it follows that Pontrjagin classes modulo 3 are homotopy type invariants. Proofs will be left to the reader.

These characteristic classes  $q_i(\xi)$  generalize to play an important role in the theory of fibrations with a homotopy sphere as fiber. Compare [Milnor, 1968], [Stasheff], [May].

We conclude with three problems for the reader, all taken from [Hirzebruch].

*Problem 19-A.* Let  $\{T_n\}$  be the multiplicative sequence of polynomials belonging to the power series  $f(t) = t/(1 - e^{-t})$ . Then the *Todd genus*  $T[M]$  of a complex  $n$ -dimensional manifold is defined to be the

characteristic number  $\langle T_n(c_1, \dots, c_n), \mu_{2n} \rangle$ . Prove that  $T[\mathbb{P}^n(\mathbb{C})] = +1$ , and prove that  $\{T_n\}$  is the only multiplicative sequence with this property.

*Problem 19-B.* If  $\{K_n\}$  is the multiplicative sequence belonging to  $f(t) = 1 + \lambda_1 t + \lambda_2 t^2 + \dots$ , let us indicate the dependence on the coefficients  $\lambda_i$  by setting  $K_n(x_1, \dots, x_n) = k_n(\lambda_1, \dots, \lambda_n, x_1, \dots, x_n)$ , where  $k_n$  is a polynomial with integer coefficients. By considering the case where  $\lambda_1, \dots, \lambda_n$  are the elementary symmetric functions in  $n$  indeterminates, prove the symmetry property  $k_n(x_1, \dots, x_n, \lambda_1, \dots, \lambda_n) = k_n(\lambda_1, \dots, \lambda_n, x_1, \dots, x_n)$ . In particular, prove that the coefficient of  $x_{i_1} \dots x_{i_r}$  in the polynomial  $K_n(x_1, \dots, x_n)$  is equal to  $s_{i_1, \dots, i_r}(\lambda_1, \dots, \lambda_n)$ .

*Problem 19-C.* Using Cauchy's identity

$$f(t) \frac{d(t/f(t))}{dt} = 1 - t \frac{d \log f(t)}{dt} = 1 + \sum (-1)^j s_j(\lambda_1, \dots, \lambda_j) t^j,$$

prove that the coefficient of  $p_n$  in the L-polynomial  $L_n(p_1, \dots, p_n)$  is equal to  $2^{2k}(2^{2k-1}-1)B_k/(2k)! \neq 0$ . (Compare Appendix B.)

## §20. Combinatorial Pontrjagin Classes

For any triangulated manifold  $M^n$ , [Thom, 1958] has defined classes  $\ell_i \in H^{4i}(M^n; \mathbb{Q})$  which are combinatorial (i.e., piecewise linear) invariants. (See also [Rohlin and Švarc].) In the case of a smooth manifold, suitably triangulated, these coincide with the Hirzebruch classes  $L_i(p_1, \dots, p_i)$  of the tangent bundle  $\tau^n$ .

Now recall (Problem 19-C) that the coefficient of  $p_i$  in the polynomial  $L_i(p_1, \dots, p_i)$  is non-zero. Hence it follows by induction that the equations  $\ell_i = L_i(p_1, \dots, p_i)$  can be uniquely solved for the Pontrjagin classes  $p_i$  as polynomial functions of  $\ell_1, \dots, \ell_i$ . For example

$$p_1 = 3\ell_1 ,$$

$$p_2 = (45\ell_2 + 9\ell_1^2)/7 ,$$

and so on. Thus it follows that the rational Pontrjagin classes  $p_i(\tau^n) \in H^{4i}(M^n; \mathbb{Q})$  are piecewise linear invariants. This section contains an exposition of these results.

In 1965 [Novikov] proved the much sharper statement that rational Pontrjagin classes are *topological* invariants. (Compare the Epilogue.) We will not try to discuss this sharper theorem.

### The Differentiable Case

In order to motivate the combinatorial definition, we will first give a new interpretation for the classes  $L_i(p_1, \dots, p_i)$  of a smooth  $n$ -manifold. The restriction  $4i < (n-1)/2$  will be needed at first.

Let  $M^n$  be a smooth, compact  $n$ -dimensional manifold, and let  $f: M^n \rightarrow S^{n-4i}$  be a smooth (i.e., infinitely differentiable) map.

LEMMA 20.1. *There exists a dense open subset of  $S^{n-4i}$  consisting of points  $y$  such that the inverse image  $f^{-1}(y)$  is a smooth  $4i$ -dimensional manifold with trivial normal bundle in  $M^n$ .*

*Proof.* By the theorem of Brown and Sard (Section 18), the set of regular values of  $f$  is everywhere dense in  $S^{n-4i}$ . This set is open since it is the complement of the continuous image of a compact subset of  $M^n$ . For every regular value  $y$ , the inverse image  $f^{-1}(y)$  is smooth, compact, and has normal bundle which is trivial, since it is induced from the normal bundle of  $y$  in  $S^{n-4i}$ . ■

Now suppose that  $M^n$  is an oriented manifold. Then the orientations of  $M^n$  and  $S^{n-4i}$  determine an orientation for  $f^{-1}(y)$ , using the Whitney sum decomposition  $\tau^{4i}(f^{-1}(y)) \oplus \nu^{n-4i} = \tau^n|_{f^{-1}(y)}$ .

Let  $u$  and  $\mu_n$  denote the standard generators of  $H^k(S^k; \mathbb{Z})$  and  $H_n(M_n; \mathbb{Z})$  respectively, and let  $\tau^n$  denote the tangent bundle of  $M^n$ . The class  $L_i(p_1(\tau^n), \dots, p_i(\tau^n)) \in H^{4i}(M^n; \mathbb{Q})$  will be written briefly as  $L_i(\tau^n)$ .

LEMMA 20.2. *For every smooth map  $f: M^n \rightarrow S^{n-4i}$  and every regular value  $y$ , the Kronecker index*

$$\langle L_i(\tau^n) \cup f^*(u), \mu_n \rangle$$

*is equal to the signature  $\sigma$  of the manifold  $M^{4i} = f^{-1}(y)$ . In the case  $4i < (n-1)/2$ , the class  $L_i(\tau^n)$  is completely characterized by these identities.*

*Proof.* Let  $\tau^{4i}$  be the tangent bundle of  $M^{4i}$ , and  $j: M^{4i} \rightarrow M^n$  the inclusion map. Then  $j$  is covered by a bundle map  $\tau^{4i} \oplus \nu^{n-4i} \rightarrow \tau^n$ . Since the normal bundle  $\nu^{n-4i}$  is trivial, this means that  $L_i(\tau^{4i})$  is equal to  $j^*L_i(\tau^n)$ . Hence the signature

$$\sigma(M^{4i}) = \langle L_i(\tau^{4i}), \mu_{4i} \rangle = \langle j^*L_i(\tau^n), \mu_{4i} \rangle$$

is equal to  $\langle L_i(\tau^n), j_*(\mu_{4i}) \rangle$ .

Now consider the cohomology class  $f^*(u) \in H^{n-4i}(M^n; \mathbb{Z})$ . Using the commutative diagram

$$\begin{array}{ccc} H^{n-4i}(S^{n-4i}, S^{n-4i-y}) & \xrightarrow{\cong} & H^{n-4i}(S^{n-4i}) \\ \downarrow & & \downarrow \\ H^{n-4i}(M^n, M^n - M^{4i}) & \longrightarrow & H^{n-4i}(M^n) \end{array}$$

we see easily that  $f^*(u)$  can be identified with the “dual cohomology class” (p. 120) to the submanifold  $M^{4i} \subset M^n$ .

We will make use of the Poincaré duality isomorphism  $a \mapsto a \cap \mu_n$  from  $H^{n-4i}(M^n)$  to  $H_{4i}(M^n)$ , defined by means of the cap product operation. (See Appendix A, pp. 276-278.) According to Problem 11-C, this isomorphism maps the dual cohomology class  $f^*(u)$  to the homology class  $j_*(\mu_{4i})$ . Hence the signature  $\langle L_i(\tau^n), j_*(\mu_{4i}) \rangle$  is equal to

$$\langle L_i(\tau^n), f^*(u) \cap \mu_n \rangle = \langle L_i(\tau^n) \cup f^*(u), \mu_n \rangle .$$

This proves the first half of 20.2.

To prove the second half, we will make use of a theorem of [Serre, p. 289] concerning the Borsuk-Spanier cohomotopy groups. If  $n < 2k-1$ , then the set of all homotopy classes of maps  $f: M^n \rightarrow S^k$  forms an abelian group, denoted by  $\pi^k(M^n)$  and called the  $k$ -th *cohomotopy group* of  $M^n$ . Serre shows that the correspondence  $f \mapsto f^*(u)$  induces a  $\mathbb{C}$ -isomorphism

$$\pi^k(M^n) \rightarrow H^k(M^n; \mathbb{Z}) .$$

(Compare pp. 207, 208. This result is the Spanier-Whitehead dual of 18.3.)

In particular, the images  $f^*(u)$  generate a subgroup of finite index in  $H^k(M^n; \mathbb{Z})$ . Now substitute  $k = n-4i$ , so that the dimensional restriction  $n < 2k-1$  takes the form  $4i < (n-1)/2$ . If this restriction is satisfied, then by Poincaré duality (p. 128), the rational cohomology class  $L_i(\tau^n)$  is completely determined by the set of all Kronecker indices  $\langle L_i(\tau^n) \cup f^*(u), \mu_n \rangle$ . ■

REMARK. As a method for computing  $L_i(r^n)$ , Theorem 20.2 is probably hopeless. However the statement that  $\langle L_i(r^n) \cup f^*(u), \mu_n \rangle$  is an integer for every  $(f) \in \pi^{n-4i}(M^n)$  could conceivably prove useful in computing cohomotopy groups. As an example, for the complex projective space  $P^m(\mathbb{C})$ , the class  $L(r^{2m})$  is equal to

$$(a/\tanh a)^{m+1} = 1 + \frac{m+1}{3} a^2 + \frac{5m^2 + 3m - 2}{90} a^4 + \dots$$

Thus if  $m \not\equiv 2 \pmod{3}$  it follows that the image of the homomorphism

$$\pi^{2m-4}(P^m(\mathbb{C})) \rightarrow H^{2m-4}(P^m(\mathbb{C}))$$

is divisible by 3, while if  $m \equiv 0 \pmod{3}$  the image of

$$\pi^{2m-8}(P^m(\mathbb{C})) \rightarrow H^{2m-8}(P^m(\mathbb{C}))$$

is divisible by 9, and so on.

### The Combinatorial Case

The following will be a convenient class of objects to work with. Let  $K$  be a locally finite simplicial complex.

DEFINITION.  $K$  is an  $n$ -dimensional *rational homology manifold* if for each point  $x$  of  $K$  the local homology group

$$H_i(K, K-x; \mathbb{Q})$$

is zero for  $i \neq n$  and isomorphic to  $\mathbb{Q}$  for  $i = n$ .

This is equivalent to the requirement that the star boundary of every simplex of  $K$  has the rational homology of an  $(n-1)$ -sphere. If  $K$  is a compact rational homology  $n$ -manifold, then it is easy to check that each component of  $K$  is a "simple  $n$ -circuit." (See [Eilenberg and Steenrod, p. 106].) In particular, each  $(n-1)$ -simplex of  $K$  is incident to precisely two  $n$ -simplexes. Such a complex  $K$  is said to be *oriented* if it is possible to assign an orientation to each  $n$ -simplex so that the sum of all

$n$ -simplexes forms an  $n$ -dimensional cycle. By definition, this cycle represents the fundamental homology class  $\mu \in H_n(K; \mathbb{Z})$ .

Such oriented rational homology manifolds satisfy the Poincaré duality theorem with rational coefficients. See for example [Borel, 1960].

Similarly one can define the concept of an  $n$ -dimensional homology manifold-with-boundary. In this case the boundary  $\partial K$  is a homology  $(n-1)$ -manifold, and the orientation determines and is determined by a relative homology class  $\mu \in H_n(K, \partial K; \mathbb{Z})$ .

We recall some standard definitions. Let  $K$  be a simplicial complex. By a (rectilinear) *subdivision* of  $K$  is meant a simplicial complex  $K'$  together with a homeomorphism  $s: K' \rightarrow K$  which is *simplexwise linear*, i.e., maps each simplex of  $K'$  linearly into a simplex of  $K$ . A map  $f: K \rightarrow L$  between simplicial complexes is called *piecewise linear* if there exists a subdivision  $s: K' \rightarrow K$  so that the composition  $f \circ s$  is simplexwise linear.

A map  $K \rightarrow L$  is said to be *simplicial* if it is simplexwise linear and maps each vertex of  $K$  to a vertex of  $L$ . If  $K$  is compact, then given any piecewise linear map  $f: K \rightarrow L$  it can be shown that there exist subdivisions  $s: K' \rightarrow K$  and  $t: L' \rightarrow L$  so that the composition  $t^{-1} \circ f \circ s: K' \rightarrow L'$  is simplicial. See for example [Rourke and Sanderson, p. 17].

Let  $\Sigma^r$  denote the boundary of the standard  $(r+1)$ -simplex. Our key lemma will be the following.

**LEMMA 20.3.** *Let  $K^n$  be a compact rational homology  $n$ -manifold, and let  $f: K^n \rightarrow \Sigma^r$  be a piecewise linear map, with  $n - r = 4i$ . Then for almost all  $y \in \Sigma^r$  the inverse image  $f^{-1}(y)$  is a compact rational homology  $4i$ -manifold. Given orientations for  $K^n$  and  $\Sigma^r$ , there is an induced orientation for  $f^{-1}(y)$ . Furthermore the signature  $\sigma(f^{-1}(y))$  of this oriented homology manifold is independent of  $y$  for almost all  $y$ .*

Here "almost all  $y$ " can be taken to mean "except for  $y$  belonging to some lower dimensional subcomplex."

It will be convenient to introduce the abbreviated notation  $\sigma(f)$  for this common value  $\sigma(f^{-1}(y))$ . [There is perhaps an analogy between this definition of  $\sigma(f)$  and such classical homotopy invariants as the "degree" and the "Hopf invariant" of a mapping.]

LEMMA 20.4. *The integer  $\sigma(f)$  depends only on the homotopy class of  $f$ . Furthermore, if  $4i < (n-1)/2$  so that the cohomotopy group  $\pi^i(K^n)$  is defined, then the correspondence  $(f) \mapsto \sigma(f)$  defines a homomorphism from  $\pi^i(K^n)$  to  $\mathbb{Z}$ .*

The proof of 20.3 and 20.4 will be based on the following.

LEMMA 20.5. *If  $f: K \rightarrow L$  is a simplicial mapping, and if  $y$  belongs to the interior  $U$  of a simplex  $\Delta$  of  $L$ , then  $f^{-1}(U)$  is homeomorphic to  $U \times f^{-1}(y)$ .*

The corresponding assertion for the entire closed simplex would of course be false.

*Proof.* Let  $A_0, \dots, A_r$  be the vertices of  $\Delta$ , and set  $y = t_0 A_0 + \dots + t_r A_r$ , where the  $t_i$  are positive real numbers with sum 1. Evidently any point  $x \in f^{-1}(U)$  can be expressed uniquely as a sum

$$x = s_0 A'_0 + \dots + s_r A'_r$$

where each  $A'_i$  is a boundary point of the smallest simplex of  $K$  containing  $x$  and where  $f(A'_i) = A_i$ . Note that  $f(x) = s_0 A_0 + \dots + s_r A_r$ . The required homeomorphism  $f^{-1}(U) \rightarrow U \times f^{-1}(y)$  is now defined by the formula  $x \mapsto (f(x), t_0 A'_0 + \dots + t_r A'_r)$ . ■

It follows incidentally that  $f^{-1}(y)$  is homeomorphic to  $f^{-1}(y')$  for all  $y$  and  $y'$  in  $U$ .



*Proof of 20.3.* Subdivide  $K^n$  and  $\Sigma^r$  so that  $f$  is simplicial. This is possible since  $K^n$  is compact. Assume that  $y$  belongs to the interior  $U$  of a top dimensional simplex  $\Delta^r$  of the subdivided  $\Sigma^r$ . Then by 20.5,  $U \times f^{-1}(y)$  has the local rational homology groups of an  $n$ -manifold. Since  $U$  has the local homology groups  $H_*(U, U-x)$  of an  $r$ -manifold, it follows easily that  $f^{-1}(y)$  has the local rational homology groups of a manifold of dimension  $n-r = 4i$ .

This set  $f^{-1}(y)$  can be given the structure of a simplicial complex. In fact, taking further subdivisions, so that  $y$  is a vertex of the subdivided  $\Sigma^r$ , it follows that  $f^{-1}(y)$  is a subcomplex of the correspondingly subdivided  $K^n$ .

Given orientations for  $U$  and  $U \times f^{-1}(y)$ , it is not difficult to construct an induced orientation for  $f^{-1}(y)$ , using for example the homology cross product operation. Hence the signature  $\sigma(f^{-1}(y))$  is defined. We noted above that  $f^{-1}(y')$  is homeomorphic to  $f^{-1}(y)$  for all  $y' \in U$ . Hence the integer valued function  $\sigma(f^{-1}(y))$  is certainly independent of  $y$  for  $y \in U$ .

Suppose that  $f$  and  $g$  are homotopic piecewise linear maps from  $K^n$  to  $\Sigma^r$ . Choosing a piecewise linear homotopy

$$h: K^n \times [0, 1] \rightarrow \Sigma^r,$$

then subdividing so that  $h$  is simplicial and choosing  $y \in U$  as above, a similar argument shows that  $h^{-1}(y)$  is a rational homology manifold-with-boundary, bounded by the disjoint union  $g^{-1}(y) + (-f^{-1}(y))$ . Since the signature of a boundary is zero, this proves that

$$\sigma(f^{-1}(y)) = \sigma(g^{-1}(y))$$

for almost all  $y$ .

Now suppose that we are given two different points  $y_1$  and  $y_2$  of  $\Sigma^r$ , each of which satisfies the condition that the function  $y \mapsto \sigma(f^{-1}(y))$  is constant throughout a neighborhood of  $y_i$ . Choosing a piecewise linear

homeomorphism  $u: \Sigma^r \rightarrow \Sigma^r$ , homotopic to the identity, with  $u(y_1) = y_2$ , it follows that  $u \circ f$  is homotopic to  $f$ , and hence that

$$\sigma(f^{-1} u^{-1}(z)) = \sigma(f^{-1}(z))$$

for almost all  $z$ . Choosing  $z$  close to  $y_2$ , so that  $u^{-1}(z)$  is close to  $y_1$ , this implies that

$$\sigma(f^{-1}(y_1)) = \sigma(f^{-1}(y_2)) ,$$

as required. ■

*Proof of 20.4.* It follows immediately from the argument above that  $\sigma(f)$  depends only on the homotopy class of  $f$ . To show that this correspondence  $(f) \mapsto \sigma(f)$  is additive, first recall the construction of the group operation in  $\pi^r(K^n)$ . Given two maps  $f, g: K^n \rightarrow \Sigma^r$  we can form the map  $(f, g): x \mapsto (f(x), g(x))$  from  $K^n$  to  $\Sigma^r \times \Sigma^r$ . If  $n < 2r$ , this can be deformed into the subcomplex

$$\Sigma^r \vee \Sigma^r = (\Sigma^r \times \text{point}) \cup (\text{point} \times \Sigma^r) \subset \Sigma^r \times \Sigma^r ,$$

and if  $n < 2r-1$ , the resulting map  $K^n \rightarrow \Sigma^r \vee \Sigma^r$  is unique up to homotopy. (The hypothesis that  $(f, g)$  maps  $K^n$  into  $\Sigma^r \vee \Sigma^r$  is equivalent to the hypothesis that for every  $x \in K^n$ , either  $f(x)$  or  $g(x)$  is the base point.) Now mapping  $\Sigma^r \vee \Sigma^r$  to  $\Sigma^r$  by the "folding map," which is the identity on each copy of  $\Sigma^r$ , we obtain a composite map  $h: K^n \rightarrow \Sigma^r$ , representing the required sum  $(f) + (g)$ .

If  $f$  and  $g$  are chosen within their homotopy classes so that for all  $x$  either  $f(x)$  or  $g(x)$  is the basepoint, note that  $h(x)$  is defined simply by

$$h(x) = f(x) \text{ if } f(x) \neq \text{base point} ,$$

$$h(x) = g(x) \text{ if } f(x) = \text{base point} .$$

Hence  $h^{-1}(y)$  is the disjoint union of  $f^{-1}(y)$  and  $g^{-1}(y)$ , for  $y \neq$  base point, and it follows immediately that  $\sigma(h) = \sigma(f) + \sigma(g)$ . ■

We can now prove one of the main results of this section. We continue to assume that the finite simplicial complex  $K^n$  is an oriented rational homology manifold.

**THEOREM 20.6.** *For  $4i < (n-1)/2$ , there is one and only one cohomology class*

$$\ell_i \in H^{4i}(K^n; \mathbb{Q})$$

*which satisfies the identity*

$$\langle \ell_i \cup f^*(u), \mu_n \rangle = \sigma(f)$$

*for every map  $f: K^n \rightarrow \Sigma^{n-4i}$ .*

Clearly this class  $\ell_i = \ell_i(K^n)$  is invariant under piecewise linear homeomorphism.

*Proof.* As already noted, the homomorphism

$$\pi^{n-4i}(K^n) \rightarrow H^{n-4i}(K^n; \mathbb{Z})$$

defined by  $(f) \mapsto f^*(u)$  is a  $\mathcal{C}$ -isomorphism. (Compare p. 233.) It follows easily that there is one and only one homomorphism

$$\sigma': H^{n-4i}(K^n; \mathbb{Z}) \rightarrow \mathbb{Q}$$

which makes the following diagram commutative.

$$\begin{array}{ccc} \pi^{n-4i}(K^n) & \xrightarrow{\quad} & H^{n-4i}(K^n; \mathbb{Z}) \\ \downarrow \sigma & & \downarrow \sigma' \\ \mathbb{Z} & \subset & \mathbb{Q} \end{array}$$

Now, by Poincaré duality, we have

$$\sigma'(x) = \langle \ell_i \cup x, \mu_n \rangle$$

for some uniquely defined rational cohomology class  $\ell_i$ . ■

Let us compare the combinatorial and differentiable definitions. We will need some basic results of J. H. C. Whitehead. Let  $M = M^n$  be a smooth manifold. By a *smooth triangulation* of  $M$  is meant a homeomorphism

$$t : K \rightarrow M ,$$

where  $K$  is a simplicial complex, such that the restriction of  $t$  to each closed simplex of  $K$  is smooth and of maximal rank everywhere.

**THEOREM OF WHITEHEAD.** *Every smooth paracompact manifold possesses a smooth triangulation. In fact, if  $M$  is a smooth paracompact manifold-with-boundary, then every smooth triangulation  $K_0 \rightarrow \partial M$  can be extended to a smooth triangulation  $K \rightarrow M$ , where  $K$  is a simplicial complex containing  $K_0$  as subcomplex. Finally, if  $t_1 : K_1 \rightarrow M$  and  $t_2 : K_2 \rightarrow M$  are two different smooth triangulations of  $M$ , then the homeomorphism  $t_2^{-1} \circ t_1 : K_1 \rightarrow K_2$  is homotopic to a piecewise linear homeomorphism from  $K_1$  to  $K_2$ .*

Thus the smooth manifold  $M$  determines a simplicial complex  $K$  which is unique up to piecewise linear homeomorphism. For the proofs we refer to [Whitehead, 1940], [Munkres, 1966].

Now consider the characteristic cohomology class  $\ell_i(K)$ . Using the isomorphism  $t^* : H^{4i}(M) \rightarrow H^{4i}(K)$  we obtain a corresponding class

$$t^{*-1} \ell_i(K) \in H^{4i}(M) ,$$

still assuming that  $4i < (n-1)/2$ . This class does not depend on the choice of smooth triangulation. For if  $t_1 : K_1 \rightarrow M$  is another smooth triangulation, then  $t_1^{-1} \circ t$  is homotopic to a piecewise linear homeomorphism, hence

$$t^{*-1} \ell_i(K) = t_1^{*-1} \ell_i(K_1) .$$

This well defined rational cohomology class will be denoted briefly by  $\ell_i(M)$ .

**THEOREM 20.7.** *The class  $\ell_i(M^n)$ , defined for a smooth manifold by a combinatorial procedure, is equal to the Hirzebruch class  $L_i(p_1, \dots, p_i)$  of the tangent bundle of  $M^n$ .*

*Proof.* Let  $f: M^n \rightarrow S^r$  be a smooth map. We will construct a diagram

$$\begin{array}{ccc}
 K^n & \xrightarrow{t} & M^n \\
 \downarrow g & & \downarrow f \\
 L^r & \xrightarrow{s} & S^r
 \end{array} ,$$

commutative up to homotopy, where  $g$  is piecewise linear and  $t, s$  are smooth triangulations, so that

$$\sigma(f^{-1}(y)) = \sigma(g^{-1}(z))$$

for  $y$  belonging to a non-vacuous open set in  $S^r$  and for  $z$  belonging to a non-vacuous open set in  $L^r$ . The complex  $L^r$  is necessarily piecewise linearly homeomorphic to  $\Sigma^r$ . Together with 20.2 and 20.6, this will complete the proof.

Let  $y_0 \in S^r$  be a regular value of  $f$ . If  $B$  is a sufficiently small ball around  $y_0$ , then it is not difficult to show that the inverse image  $f^{-1}(B)$  is diffeomorphic to  $f^{-1}(y_0) \times B$  under a diffeomorphism which preserves the projection map to  $B$ . Choose smooth triangulations

$$t_1 : K_1 \rightarrow f^{-1}(y_0)$$

and

$$t_2 : K_2 \rightarrow B .$$

Then the smooth triangulation

$$t_1 \times t_2 : K_1 \times K_2 \rightarrow f^{-1}(y_0) \times B \subset M^n$$

restricts to a smooth triangulation

$$K_1 \times \partial K_2 \rightarrow f^{-1}(y_0) \times \partial B$$

of the boundary which, by Whitehead's theorem, extends to a smooth triangulation

$$K_3 \rightarrow M^n\text{-interior } (f^{-1}(y_0) \times B)$$

of the complementary domain. Setting  $K^n = K_1 \times K_2 \cup K_3$  (and subdividing if necessary), we thus obtain a smooth triangulation  $t: K^n \rightarrow M^n$ . Similarly  $t_2$  can be extended to a smooth triangulation  $s: L^r \rightarrow S^r$ .

Now the projection map  $K_1 \times K_2 \rightarrow K_2 \subset L^r$  can be extended to a piecewise linear map  $g: K^n \rightarrow L^r$ , in such manner that the complement of  $K_1 \times K_2$  maps to the complement of  $K_2$ . It is then easy to check that the composition  $s \circ g$  is homotopic to  $f \circ t$ . Furthermore

$$f^{-1}(y) \cong g^{-1}(z)$$

for every  $y \in B$  and every  $z \in K_2$ , so that the signature  $\sigma(f^{-1}(y))$  is certainly equal to  $\sigma(g^{-1}(z))$ . ■

So far, the condition  $4i < (n-1)/2$  has been imposed. However, given  $K^n$ , one can always form the product space  $K^n \times \Sigma^m$  with  $m$  large. The class  $\ell_i(K^n)$  can then be defined as the class induced from  $\ell_i(K^n \times \Sigma^m)$  by the natural inclusion map. It is not hard to show that this new class is well defined, and has the expected properties. In particular the Kronecker index  $\langle \ell_i(K^{4i}), \mu_{4i} \rangle$  is always equal to the signature  $\sigma(K^{4i})$ .

Another extension which can easily be made is to homology manifolds-with-boundary. It is only necessary to substitute the relative cohomotopy groups  $\pi^{n-4i}(K^n, \partial K^n)$  and the Lefschetz duality theorem in the above discussion.

### Applications

We will first discuss an example which was discovered independently by [Thom, 1955-56, p. 81], [Tamura], and [Shimada]. Two lemmas will be needed.

LEMMA 20.8. Let  $\xi$  be a smooth vector bundle with projection map  $\pi: E \rightarrow B$ . Then the tangential Pontrjagin class  $p(E) = p(\tau_E)$  of the total space is equal to  $\pi^*(p(\xi)p(\tau_B))$ , up to 2-torsion.

*Proof.* Choosing a Riemannian metric on  $E$ , the tangent bundle  $\tau_E$  clearly splits as the Whitney sum of the bundle of vectors tangent to the fiber and the bundle of vectors normal to the fiber. Since these are isomorphic to  $\pi^*(\xi)$  and  $\pi^*(\tau_B)$  respectively, the conclusion follows. ■

Let  $u \in H^4(S^4)$  denote the standard cohomology generator.

LEMMA 20.9. There exists an oriented 4-plane bundle  $\xi^4$  over  $S^4$  with  $p_1(\xi^4) = -2u$  and with  $e(\xi^4) = u$ .

*Proof.* Let  $\mathbb{H}$  denote the non-commutative field of quaternions. (The letter  $\mathbb{H}$  honors William Rowan Hamilton.) Then we can form the projective space  $P^m(\mathbb{H})$  of quaternion lines through the origin in  $\mathbb{H}^{m+1}$ . This is a smooth  $4m$ -dimensional manifold. There is a canonical "quaternion line bundle"  $\gamma$  over  $P^m(\mathbb{H})$  whose total space  $E(\gamma)$  is the set of all pairs  $(L, v)$  consisting of a quaternion 1-dimensional subspace  $L \subset \mathbb{H}^{m+1}$  and a vector  $v \in L$ . The space of unit vectors in  $E(\gamma)$  can be identified with the unit sphere  $S^{4m+3} \subset \mathbb{H}^{m+1}$ .

Using the natural inclusion mappings  $\mathbb{R} \subset \mathbb{C} \subset \mathbb{H}$ , it follows that there is an underlying complex 2-plane bundle, which we denote by  $\gamma_{\mathbb{C}}$ , and an underlying real 4-plane bundle  $\gamma_{\mathbb{R}}$ , all over the same base space  $P^m(\mathbb{H})$ . From the Gysin sequence of  $\gamma_{\mathbb{R}}$ , we see that the cohomology ring  $H^*(P^m(\mathbb{H}))$  with integer coefficients is a truncated polynomial ring, generated by the Euler or Chern class

$$e(\gamma_{\mathbb{R}}) = c_2(\gamma_{\mathbb{C}}) \in H^4(P^m(\mathbb{H})) .$$

Denoting this cohomology generator briefly by  $u \in H^4(P^m(\mathbb{H}))$ , it follows that the total Chern class is given by

$$c(\gamma_C) = 1 + u ,$$

hence the total Pontrjagin class is

$$p(\gamma_R) = (1 - u)^2 = 1 - 2u + u^2 ,$$

by Section 15.5. Now specializing to the quaternion projective line  $P^1(\mathbb{H}) \cong S^4$ , we have

$$p_1(\gamma_R) = -2u, \quad e(\gamma_R) = u$$

as required. ■

For any even integer  $k$ , it follows that there exists a bundle  $\xi$  over  $S^4$  with  $p_1(\xi) = ku$ . One can simply take  $\xi = f^*(\gamma_R)$  where  $f: S^4 \rightarrow S^4$  is a map of degree  $-k/2$ . This is a best possible result, since  $p_1(\xi)$  cannot be an odd multiple of  $u$  by Problem 15-A.

(For vector bundles over the sphere  $S^{4m}$  the corresponding best possible result is that the Pontrjagin class  $p_m(\xi)$  can be any multiple of  $(2m-1)! \text{ G.C.D. } (m+1, 2)u$ . The proof of this statement is based on the Bott periodicity theorem. Compare [Bott, 1958-59].)

**EXAMPLE 1.** Let  $\xi^n$  be a smooth  $n$ -plane bundle over the sphere  $S^4$ . For convenience, we assume that  $n \geq 5$ . Choosing a Euclidean metric, let  $E' \subset E(\xi^n)$  be the set of vectors of length  $\leq 1$ , and let  $\partial E'$  be the set of vectors of length precisely 1.

Using the remarks above, we see that  $p_1(\xi^n) = ku$  where  $k$  can be an arbitrary even integer. Hence

$$p_1(E(\xi^n)) = k\pi^*(u)$$

by 20.8. Since  $\partial E'$  has trivial normal bundle in  $E(\xi^n)$ , it follows that

$$p_1(\partial E') = ku'$$

where  $u' \in H^4(\partial E')$  is the standard generator which corresponds to  $u$  under the homomorphism



$$H^4(S^4) \rightarrow H^4(\partial E')$$

from the Gysin sequence of  $\xi^n$ .

Since the Pontrjagin class  $p_1$  of the smooth manifold  $\partial E'$  is a combinatorial invariant, it follows that the even integer  $|k|$  is also a combinatorial invariant. *Thus as  $k$  varies we obtain infinitely many smooth manifolds  $\partial E'$  of fixed dimension  $n+3 \geq 8$  which are combinatorially distinct.*

On the other hand, according to [James and Whitehead], these manifolds  $\partial E'$  for fixed  $n$  fall into a finite number (namely 13) of distinct homotopy types. *Thus for any fixed dimension  $\geq 8$  there must exist two smooth simply-connected manifolds which have the same homotopy type but are not piecewise linearly homeomorphic.* (The dimension 8 can easily be improved to 7.)

Using Novikov's theorem that rational Pontrjagin classes are topological invariants, it follows of course that these manifolds are not even homeomorphic.

A quite different example of manifolds which have the same homotopy type but are not homeomorphic involves the study of the fundamental group, for example of a 3-dimensional lens space. (See [Brody], [Chapman].)

The next example is due to [Thom, 1958]. (See also [Milnor, 1956] and [Shimada]. We must first sharpen 20.9.

LEMMA 20.10. *Given integers  $k, \ell$  satisfying  $k \equiv 2\ell \pmod{4}$ , there exists an oriented 4-plane bundle  $\xi$  over  $S^4$  with  $p_1(\xi) = ku$ ,  $e(\xi) = \ell u$ .*

(These integers  $k$  and  $\ell$  actually determine the isomorphism class of the bundle  $\xi$ , since the homotopy group  $\pi_4(\tilde{G}_4) \cong \pi_3(SO_4)$  is isomorphic to  $\mathbb{Z} \oplus \mathbb{Z}$ .)

*Proof of 20.10.* Recall that the space of oriented 4-planes in  $\mathbb{R}^\infty$  is denoted by  $\tilde{G}_4$ . For every homotopy class  $(f)$  in the homotopy group  $\pi_4(\tilde{G}_4)$  we can form the cohomology class

$$p_1(f^*\tilde{\gamma}^4) = f^*p_1(\tilde{\gamma}^4)$$

in the group  $H^4(S^4)$  with integer coefficients by pulling the universal bundle  $\tilde{\gamma}^4$  back to the 4-sphere and then taking its Pontrjagin class. This correspondence  $(f) \mapsto p_1(f^*\tilde{\gamma}^4)$  from  $\pi_4(\tilde{G}_4)$  to  $H^4(S^4) \cong \mathbb{Z}$  is an additive homomorphism, as one sees by noting that

$$\langle p_1(f^*\tilde{\gamma}^4), \mu_4 \rangle = \langle p_1(\tilde{\gamma}^4), f_*(\mu_4) \rangle$$

where the Hurewicz homomorphism

$$(f) \mapsto f_*(\mu_4)$$

is well known to be a homomorphism. Similarly the Euler class gives rise to an additive homomorphism

$$(f) \mapsto e(f^*\tilde{\gamma}^4)$$

from  $\pi_4(\tilde{G}_4)$  to  $H^4(S^4) \cong \mathbb{Z}$ .

Now the tangent bundle of  $S^4$  is isomorphic to  $f_1^*\tilde{\gamma}^4$ , and the bundle  $\gamma_{\mathbb{R}}$  of 20.9 is isomorphic to  $f_2^*\tilde{\gamma}^4$  for suitable maps  $f_1, f_2: S^4 \rightarrow \tilde{G}_4$ . Thus

$$p_1(f_1^*\tilde{\gamma}^4) = 0 \quad , \quad e(f_1^*\tilde{\gamma}^4) = 2u$$

$$p_1(f_2^*\tilde{\gamma}^4) = -2u, \quad e(f_2^*\tilde{\gamma}^4) = u .$$

Taking a suitable linear combination  $(f)$  of  $(f_1)$  and  $(f_2)$ , we can now clearly obtain

$$p_1(f^*\tilde{\gamma}^4) = ku, \quad e(f^*\tilde{\gamma}^4) = lu$$

for any integers  $k$  and  $l$  satisfying  $k \equiv 2l \pmod{4}$ . ■

EXAMPLE 2. For any integer  $k \equiv 2 \pmod{4}$ , there exists by 20.10 an oriented 4-plane bundle  $\xi$  over  $S^4$  with

$$p_1(\xi) = ku, \quad e(\xi) = u.$$

Using the Gysin sequence of  $\xi$ , it follows easily that the space  $\partial E'$  of unit vectors in  $E(\xi)$  has the homotopy type of the sphere  $S^7$ . In fact this manifold  $\partial E'$  is actually homeomorphic to the 7-sphere. As a smooth manifold, it can be obtained by identifying the boundaries of two copies of the unit 7-disk by a suitable (but possibly exotic) diffeomorphism between their boundary 6-spheres. This fact is proved directly in [Milnor, 1956], and is also a consequence of the Generalized Poincaré Hypothesis as proved by [Smale]. Now starting with a smooth triangulation of the 6-sphere and then extending to smooth triangulations of the two 7-disks, it follows easily that *the manifold  $\partial E'$  is even combinatorially equivalent to the 7-sphere.*

Consider the Thom space  $T = T(\xi)$ . Evidently  $T$  can be identified with the manifold obtained from  $E'$  by adjoining a cone over  $\partial E'$ . Choosing a smooth triangulation of  $E'$ , since  $\partial E'$  is a combinatorial sphere, it follows that  $T = T(\xi)$  can be triangulated as a piecewise linear manifold. That is it can be triangulated so that every point of  $T$  has a neighborhood piecewise linearly homeomorphic to  $\mathbb{R}^8$ .

According to 18.1 or 18.2, the homology groups of  $T$  are infinite cyclic in dimensions 0, 4, 8, and zero otherwise. Thus the signature  $\sigma(T)$  must be  $\pm 1$ , and choosing the orientation correctly we may assume that  $\sigma(T) = +1$ .

By 20.8 the tangential Pontrjagin class  $p_1(E')$  is  $k$  times a cohomology generator. Hence  $p_1(T)$  is  $k$  times a generator, and the Pontrjagin number  $p_1^2[T]$  must be equal to  $k^2$ . Using the signature theorem

$$\sigma(T) = \frac{7}{45} p_2[T] - \frac{1}{45} p_1^2[T],$$

it follows that the other Pontrjagin number is given by

$$p_2[T] = (45 + k^2)/7 .$$

Here  $k$  can be any integer congruent to 2 modulo 4. But if  $k \not\equiv \pm 2 \pmod{7}$  this is not an integer. (For example if  $k = 6$ , then  $p_2[T]$  is not an integer.) Since the Pontrjagin numbers of a smooth manifold must be integers, we have proved the following assertion.

*For  $k \not\equiv \pm 2 \pmod{7}$ , the triangulated 8-dimensional manifold  $T = T(\xi)$  possesses no smoothness structure which is compatible with the given triangulation.*

As a corollary, it follows that *the smooth 7-dimensional manifold  $\partial E'$  (which is homeomorphic to  $S^7$ ) is not diffeomorphic to  $S^7$ .* For otherwise  $T$  could clearly be given a compatible smoothness structure.

We conclude with a problem for the reader.

*Problem 20-A.* Let  $\tau$  be the tangent bundle of the quaternion projective space  $P^m(\mathbb{H})$ . (See the proof of 20.9.) Using the isomorphism  $\tau \cong \text{Hom}_{\mathbb{H}}(\gamma, \gamma^\perp)$  of real vector bundles show that

$$\tau \oplus \text{Hom}_{\mathbb{H}}(\gamma, \gamma) \cong \text{Hom}_{\mathbb{H}}(\gamma, \mathbb{H}^{m+1}) ,$$

and hence that  $p(\tau) = (1+u)^{2m+2}/(1+4u)$ . (Compare [Szczarba] as well as Section 14.10.)

## Epilogue

We will give a very brief survey of some of the major developments in characteristic classes in the years since these notes were originally written. For other developments the reader should consult [Husemoller], [Adams, 1972], and [Atiyah].

### Non-Differentiable Manifolds

The theory of real vector bundles is ideally suited to the study of smooth manifolds, just as the theory of complex vector bundles is suited to complex manifolds. If we are given some different category of manifolds, then it is useful to look for an appropriate corresponding type of bundle. Consider for example the category of all piecewise linear manifolds and piecewise linear mappings. An appropriate type of bundle for this category can be described as follows. Let  $B$  be a locally finite simplicial complex.

**DEFINITION.** A *piecewise linear  $\mathbb{R}^n$ -bundle* over  $B$  consists of a simplicial complex  $E$  and a piecewise linear map  $p: E \rightarrow B$  satisfying the following local triviality condition. Each point of  $B$  must possess an open neighborhood  $U$  so that  $p^{-1}(U)$  is piecewise linearly homeomorphic to  $U \times \mathbb{R}^n$  under a homeomorphism which is compatible with the projection map to  $U$ . (Here the open subset  $U$  has the structure of a simplicial complex by Runge's theorem. See [Alexandroff and Hopf].)

The *piecewise linear tangent bundle* of a piecewise linear  $n$ -manifold  $M$  can be constructed as follows. According to B. Mazur (unfortunately unpublished) there exists a neighborhood  $E$  of the diagonal in  $M \times M$  so that the projection  $(x, y) \mapsto x$  from  $E$  to  $M$  constitutes a piecewise

linear  $\mathbb{R}^n$ -bundle. Furthermore this bundle is unique up to isomorphism. (For the analogous theorem in the topological category see [Kister]. Without using Mazur's theorem, one could base this discussion on the slightly more esoteric notion of a piecewise linear microbundle. See [Milnor, 1964].)

Piecewise linear  $\mathbb{R}^n$ -bundles over  $B$  are classified by mappings of the base space  $B$  into a certain "universal base space" or "classifying space," which is called  $B(\text{PL}_n)$ . Thus the theory of characteristic classes for piecewise linear manifolds coincides with the computation of  $H^*B(\text{PL}_n)$ .

Passing to the direct limit as  $n \rightarrow \infty$ , there is a canonical map

$$B(O) \rightarrow B(\text{PL}) .$$

Here  $B(O)$  denotes the stable Grassmann manifold  $\lim_{\rightarrow} B(O_n) = \lim_{\rightarrow} G_n(\mathbb{R}^\infty)$ . According to [Hirsch] and Mazur, the relative homotopy group

$$\pi_k(B(\text{PL}), B(O))$$

is isomorphic to the group  $\Gamma_{k-1}$  consisting of all oriented diffeomorphism classes of twisted  $(k-1)$ -spheres (i.e., smooth manifolds obtained by pasting together the boundaries of two closed  $(k-1)$ -disks). This group is trivial for  $k \leq 7$ , and is finite for all values of  $k$ . See [Kervaire-Milnor, 1963] and [Cerf]. *It follows that the rational cohomology  $H^*(B(\text{PL}); \mathbb{Q})$  is isomorphic to  $H^*(B(O); \mathbb{Q})$ , being a polynomial algebra generated by the Pontrjagin classes.* (Compare Section 20.) Note however that with integral coefficients, the map  $H^*(B(\text{PL}))/\text{torsion} \rightarrow H^*(B(O))/\text{torsion}$  is not an epimorphism. (Compare the integrality conditions in Example 2 of Section 20.) For the cohomology of  $B(\text{PL})$  with other coefficients, see [Williamson] and [Brumfiel-Madsen-Milgram].

A fundamental theorem of [Hirsch] and [Munkres, 1964-68] asserts that a piecewise linear manifold  $M$  possesses a compatible smoothness structure if and only if the classifying map

$$M \rightarrow B(\text{PL})$$

for its stable tangent bundle lifts to  $B(O)$  (compare [Milnor, 1964]), or equivalently if and only if each of a sequence of obstructions lying in the groups  $H^k(M; \Gamma_{k-1})$  is zero.

The theory of topological  $\mathbb{R}^n$ -bundles and topological tangent bundles is completely analogous. In this case the classifying space is denoted by  $B(\text{Top}_n)$ . There is a canonical map

$$B(\text{PL}_n) \rightarrow B(\text{Top}_n) .$$

In the limit as  $n \rightarrow \infty$ , an amazing theorem due to [Kirby and Siebenmann] asserts that *the relative homotopy group*

$$\pi_k(B(\text{Top}), B(\text{PL}))$$

is zero for  $k \neq 4$  and cyclic of order 2 for  $k = 4$ . Further they show that a topological manifold  $M$  of dimension  $\geq 5$  can be triangulated as a piecewise linear manifold if and only if the classifying map

$$M \rightarrow B(\text{Top})$$

for its stable tangent bundle lifts to  $B(\text{PL})$ , or if and only if a single topological characteristic class in the group

$$H^4(M; \mathbb{Z}/2)$$

is zero.

It follows incidentally that the ring  $H^*(B(\text{Top}); \Lambda)$  of topological characteristic classes is isomorphic to  $H^*(B(\text{PL}); \Lambda)$  for any ring  $\Lambda$  containing  $1/2$ . This of course implies Novikov's theorem that rational Pontrjagin classes are topological invariants.

An even broader category of "manifolds" is provided by the class of all *Poincaré complexes*: that is, CW-complexes  $M$  which satisfy the Poincaré duality theorem (with arbitrary local coefficients in the non-simply connected case) with respect to some fundamental homology class  $\mu \in H_n(M; \mathbb{Z})$ .

In order to study such objects, we must introduce a very different type of "bundle." A continuous map  $p: E \rightarrow B$  is said to be a *fibration* over  $B$  or to satisfy the *covering homotopy property* if for any space  $X$  and map  $f: X \rightarrow E$  any homotopy of  $p \circ f$  can be covered by a homotopy of  $f$ . (Compare [Hurewicz], [Dold, 1963].) Such a fibration is *k-spherical* if each fiber  $p^{-1}(b)$  has the homotopy type of a  $k$ -sphere.

According to [Spivak], any simply connected Poincaré complex  $M$  admits an essentially unique spherical fibration  $E \rightarrow M$  with the property that the top homology class in the associated Thom space  $T$  belongs to the image of the Hurewicz homomorphism

$$\pi_{n+k+1}(T) \rightarrow H_{n+k+1}(T; \mathbb{Z}) .$$

More precisely this fibration, called the *Spivak normal bundle of  $M$* , is unique up to stable fiber homotopy equivalence (which we will not define).

According to [Stasheff] such spherical fibrations over  $M$  are classified, up to stable fiber homotopy equivalence, by maps into a classifying space  $B(F)$ . There are maps

$$B(O) \rightarrow B(PL) \rightarrow B(\text{Top}) \rightarrow B(F) ,$$

canonically defined up to homotopy. According to [Browder and Hirsch], a simply connected Poincaré complex  $M$  of formal dimension  $n \geq 5$  has the homotopy type of a closed piecewise linear manifold  $M'$  if and only if the classifying map  $M \rightarrow B(F)$  lifts to  $B(PL)$ . (The uniqueness problem for  $M'$ , studied first by [Novikov] in the differentiable case, is much more complicated.)

The homotopy group  $\pi_i B(F)$  is isomorphic to the stable  $(i-1)$ -stem  $\pi_{N+i-1}(S^N)$  for  $i \geq 2$  and hence is always finite. The cohomology of this classifying space  $B(F)$  has been studied by [Milgram], [May], and others.

The computations of  $H^*(BPL)$  and  $H^*(BF)$  involve machinery quite different from that developed in these notes. Rather than working out



these groups from particular characteristic classes, the approaches analyze the homotopy type in terms of associated fibrations or in terms of additional internal structure. [Sullivan] for example shows that, “at odd primes,”  $BO$  has the homotopy type of the fiber of  $BPL \rightarrow BF$ . [Boardman-Vogt], [May], and [Segal] have shown that the stable classifying spaces  $BPL$ ,  $B\text{Top}$ , and  $BF$  all have the homotopy types of infinite loop spaces, so not just the Steenrod algebra but also its homology analogue the Dyer-Lashof algebra can be brought to bear. Although the Wu classes of Section 19 and their Bocksteins play an important role [Milnor, Stasheff, 1968], other classes appear whose interpretation in terms of fiber space structure or geometry is far from clear [Ravenel].

### Smooth Manifolds with Additional Structure

Instead of looking at non-differentiable manifolds, we can look at smooth manifolds which are provided with some additional structure. For example we can require that the “structural group” of the tangent bundle of our  $n$ -manifold (see [Steenrod] or [Husemoller]) should be some specified subgroup of the general linear group  $GL(n, \mathbb{R})$  (or equivalently of the orthogonal group  $O(n)$ ). One important example is provided by the unitary group  $U(n) \subset O(2n)$ . This leads to the study of almost complex manifolds and the closely related complex manifolds (Section 13). Other examples are provided by the special unitary group  $SU(n) \subset O(2n)$  and the compact symplectic group  $Sp(n) \subset O(4n)$ . Similarly one can “restrict” the tangent bundle to the 2-fold covering  $Spin(n) \rightarrow SO(n)$ . For a discussion of the cobordism theories associated with these various reductions, see [Stong].

A different line of development is based on the definition of characteristic classes by means of differential forms. (See Appendix C.) These are particularly well adapted to the study of manifolds with some additional geometric structure, such as a foliation or a Riemannian metric. The vanishing of these classes in certain situations gives rise to new characteristic classes, first studied from different points of view by [Chern-Simons] and [Godbillon-Vey]. Some of these classes depend, for example,

on the conformal structure of a Riemannian manifold. Some of the corresponding characteristic numbers can take on arbitrary real values ([Bott, 72], [Baum], and [Thurston]), showing the great richness of such structures. At this writing, this branch of the theory of characteristic classes is undergoing very rapid and vigorous development. A contemporary survey is given by [Bott and Haefliger] with further developments appearing in [Amer. Math. Soc.].

### Generalized Cohomology Theories

So far we have discussed characteristic classes using ordinary cohomology theory, but using various exotic types of bundles. A quite different generalization arises if we use ordinary vector bundles, but generalize the cohomology. By definition, a *generalized cohomology theory* is a functor  $(X, A) \mapsto \mathcal{H}^*(X, A)$  from pairs of spaces to graded additive groups which satisfies the first six Eilenberg-Steenrod axioms, but fails to satisfy the dimension axiom (the axiom that  $\mathcal{H}^k(\text{point}) = 0$  for  $k \neq 0$ ). Compare [Dyer]. The first and most important example of such a generalized cohomology theory is provided by *K-theory*.

DEFINITION. For any compact space  $X$  the additive group  $K^0(X)$  is defined by means of a presentation by generators and relations as follows. There is to be one generator  $[\xi]$  for each isomorphism class of complex vector bundles  $\xi$  over  $X$  and one relation

$$[\xi \oplus \eta] = [\xi] + [\eta]$$

for each pair of complex vector bundles. For  $m > 0$  the group  $K^{-m}(X)$  can be defined as the kernel of the natural surjection

$$K^0(S^m \times X) \rightarrow K^0((\text{base point}) \times X) .$$

The tensor product operation for complex vector bundles gives rise to a product operation

$$K^{-m}(X) \otimes K^{-n}(Y) \rightarrow K^{-m-n}(X \times Y) .$$

The *Bott periodicity theorem* now asserts that the product with a standard generator in the group  $K^{-2}(\text{point}) \cong \mathbb{Z}$  yields an isomorphism

$$K^{-m}(X) \xrightarrow{\cong} K^{-m-2}(X) .$$

(This is closely related to the statement that the classifying space  $BU$  has the homotopy type of its own  $2^{\text{nd}}$  loop space.)

The ring  $KO^*(X)$  is defined similarly, using real vector bundles in place of complex vector bundles. In this case there is a periodicity theorem

$$KO^{-m}(X) \xrightarrow{\cong} KO^{-m-8}(X) .$$

As illustrations of the power of these methods, we refer the reader to [Atiyah] and [Adams, 1962-1972].

Similarly one can define the concept of a generalized homology theory. One important example is provided by the *stable homotopy groups*

$$\pi_n^S(X) = \lim_{\rightarrow} \pi_{n+k}(S^k X) ,$$

where  $S^k X$  denotes the  $k$ -fold suspension of  $X$ . Another is provided by the *oriented bordism groups*  $\Omega_n(X)$ . (Compare [Conner-Floyd].) By definition two maps

$$f_1 : M_1 \rightarrow X, \quad f_2 : M_2 \rightarrow X$$

from smooth, compact, oriented  $n$ -manifolds to  $X$  are called *bordant* if there exists a smooth, compact, oriented manifold-with-boundary  $N$  with  $\partial N = M_1 + (-M_2)$ , and a map  $N \rightarrow X$  extending  $f_1$  and  $f_2$ . The bordism classes of such maps form a group  $\Omega_n(X)$ . Note that  $\Omega_n(\text{point})$  is just the cobordism group  $\Omega_n$  of Section 17. Each such generalized homology theory is associated with a corresponding generalized cohomology theory. See [G. W. Whitehead].

In order to study characteristic classes with values in a generalized cohomology theory such as  $K^*(B)$ , one must first compute  $K^*$  of the appropriate classifying space. In the case of complex  $K$ -theory, [Atiyah

and Hirzebruch] establish an isomorphism between  $K^*(BG)$  for a compact Lie group  $G$  and the completion of the representation ring of  $G$ . (See [Anderson] for the corresponding  $KO$ -theory results.)

Just as the *orientation* of a manifold using the classical homology theory  $H_*( ; \mathbb{Z})$  plays an important role in studying homology of manifolds, so the analogous  $K$ -theory orientations play a basic role in studying the  $K$ -theory of manifolds. (Compare [Shih].) For example [Sullivan] has proved the amazing result that a  $PL$ -bundle is more or less the same thing as a spherical fibration together with a  $KO$ -orientation.

For any  $K$ -oriented bundle one can use the approach of Section 8 and Section 19 to define  $K$ -theory characteristic classes, using appropriate  $K$ -theory operations in place of the Steenrod operations. This idea was initially suggested by [Bott, 1962], and was developed more extensively by [Adams, 1965].

As a typical illustration of the usefulness of these classes, consider the work of [Anderson-Brown-Peterson] on spin cobordism. Suppose that one is given an oriented simply connected manifold  $M$  with  $w_2(M) = 0$ . In order to test whether  $M$  bounds an oriented manifold-with-boundary with  $w_2 = 0$  one must check, not only that the Stiefel-Whitney numbers (and Pontrjagin numbers) are zero, but also that all  $KO$ -characteristic numbers are zero.

If the cohomology theory is the one corresponding to complex bordism, [Conner and Floyd] have introduced Chern-type classes. The algebra in this situation turns out to be particularly manageable so that rapid progress has been made by several people, notably [Novikov, 1967] (cf. [Adams, 1967]).

## Appendix A: Singular Homology and Cohomology

This appendix will give brief proofs of a number of theorems concerning singular cohomology theory which are needed in the text. To fix our notations and our sign conventions, we will start with basic definitions. Nevertheless we will assume some familiarity with homology and cohomology theory. In particular we will assume that the reader is acquainted with those fundamental properties which are summarized in the [Eilenberg-Steenrod] axioms.

Since these lectures were first given, several texts have appeared which present cohomology theory at the level we need, notably [Hilton and Wylie], [Spanier], and [Dold, 1972].

### Basic Definitions

The *standard n-simplex* is the convex set  $\Delta^n \subset \mathbb{R}^{n+1}$  consisting of all  $(n+1)$ -tuples  $(t_0, \dots, t_n)$  of real numbers with

$$t_i \geq 0, \quad t_0 + t_1 + \dots + t_n \leq 1 .$$

Any continuous map from  $\Delta^n$  to a topological space  $X$  is called a *singular n-simplex* in  $X$ . The  $i$ -th *face* of a singular  $n$ -simplex  $\sigma: \Delta^n \rightarrow X$  is the singular  $(n-1)$ -simplex

$$\sigma \circ \phi_i: \Delta^{n-1} \rightarrow X$$

where the linear imbedding  $\phi_i: \Delta^{n-1} \rightarrow \Delta^n$  is defined by

$$\phi_i(t_0, \dots, t_{i-1}, t_{i+1}, \dots, t_n) = (t_0, \dots, t_{i-1}, 0, t_{i+1}, \dots, t_n) .$$

For each  $n \geq 0$  the *singular chain group*  $C_n(X; \Lambda)$  with coefficients in a *commutative ring*  $\Lambda$  is the free  $\Lambda$ -module having one generator  $[\sigma]$  for each singular  $n$ -simplex  $\sigma$  in  $X$ . For  $n < 0$ , the group  $C_n(X; \Lambda)$  is defined to be zero. The *boundary homomorphism*

$$\partial : C_n(X; \Lambda) \rightarrow C_{n-1}(X; \Lambda)$$

is defined by

$$\partial[\sigma] = [\sigma \circ \phi_0] - [\sigma \circ \phi_1] + \dots + (-1)^n [\sigma \circ \phi_n] .$$

The identity  $\partial \circ \partial = 0$  is easily verified. Hence we can define the  $n$ -th *singular homology group*  $H_n(X; \Lambda)$  to be the quotient module  $Z_n(X; \Lambda)/B_n(X; \Lambda)$ , where  $Z_n(X; \Lambda)$  is the kernel of  $\partial : C_n(X; \Lambda) \rightarrow C_{n-1}(X; \Lambda)$  and  $B_n(X; \Lambda)$  is the image of  $\partial : C_{n+1}(X; \Lambda) \rightarrow C_n(X; \Lambda)$ . Here and elsewhere the word "group" is used, although "left  $\Lambda$ -module" is really meant.

The *cochain group*  $C^n(X; \Lambda)$  is defined to be the dual module  $\text{Hom}_\Lambda(C_n(X; \Lambda), \Lambda)$  consisting of all  $\Lambda$ -linear maps from  $C_n(X; \Lambda)$  to  $\Lambda$ . The value of a cochain  $c$  on a chain  $\gamma$  will be denoted by  $\langle c, \gamma \rangle \in \Lambda$ . The *coboundary* of a cochain  $c \in C^n(X; \Lambda)$  is defined to be the cochain  $\delta c \in C^{n+1}(X; \Lambda)$  whose value on each  $(n+1)$ -chain  $\alpha$  is determined by the identity

$$\langle \delta c, \alpha \rangle + (-1)^n \langle c, \partial \alpha \rangle = 0 .$$

Thus we obtain corresponding modules

$$H^n(X; \Lambda) = Z^n(X; \Lambda)/B^n(X; \Lambda) = (\text{kernel } \delta)/\delta C^{n-1}(X; \Lambda)$$

which are called the *singular cohomology groups* of  $X$ .

**REMARK.** The choice of sign in this formula is based upon the following convention. Whenever two symbols of dimensions  $m$  and  $n$  are permuted, the sign  $(-1)^{mn}$  will be introduced. Here the operators  $\partial$  and  $\delta$  are considered to have dimension  $\pm 1$ . Thus our sign conventions are the same as those of [MacLane] and [Dold], but different from those of [Eilenberg-Steenrod] and [Spanier].

In some contexts, notably in obstruction theory, it is important to consider cohomology with coefficients in an arbitrary  $\Lambda$ -module. However in this appendix we consider only cohomology with coefficients in the ring  $\Lambda$  itself.

### The Relationship between Homology and Cohomology

Henceforth we will assume that  $\Lambda$  is a principal ideal domain (for example the integers, or a field). In order to simplify the notation we will omit reference to  $\Lambda$  whenever possible, writing  $H_n X$  in place of  $H_n(X; \Lambda)$  for example. The abbreviated notation  $H_* X$  will often be used to denote the entire sequence of groups  $(H_0 X, H_1 X, H_2 X, \dots)$ .

**THEOREM A.1.** *Suppose that  $H_{n-1} X$  is zero or is a free  $\Lambda$ -module. Then  $H^n X$  is canonically isomorphic to the module  $\text{Hom}_\Lambda(H_n X, \Lambda)$  consisting of all  $\Lambda$ -linear maps from  $H_n X$  to  $\Lambda$ . There is a corresponding assertion for pairs  $(X, A)$ .*

(Compare [MacLane, p. 77] or [Spanier, p. 243].) Note that the hypothesis is always satisfied if  $\Lambda$  happens to be a field.

*Proof.* Given elements  $x \in H^n X$  and  $\xi \in H_n X$  define the "Kronecker index"  $\langle x, \xi \rangle \in \Lambda$  as follows. Choose a representative cocycle  $z \in Z^n X$  for  $x$  and a representative cycle  $\zeta \in Z_n X$  for  $\xi$ ; and set  $\langle x, \xi \rangle$  equal to  $\langle z, \zeta \rangle \in \Lambda$ . The reader should verify that this does not depend on the choice of  $z$  and  $\zeta$ . Now define a homomorphism

$$k : H^n X \rightarrow \text{Hom}_\Lambda(H_n X, \Lambda)$$

by the identity  $k(x)(\xi) = \langle x, \xi \rangle$ .

*Proof that the homomorphism  $k$  is onto.* First note that the submodule  $Z_n X \subset C_n X$  is a direct summand. This follows from the fact that the quotient module

$$C_n X / Z_n X \cong B_{n-1} X \subset C_{n-1} X$$

is a submodule of a free module, and hence is free. (See for example [Kaplansky].) Therefore any homomorphism  $Z_n X \rightarrow \Lambda$  can be extended over  $C_n X$ .

Let  $f$  be an arbitrary element of  $\text{Hom}_\Lambda(H_n X, \Lambda)$ . The composition

$$Z_n X \longrightarrow H_n X \xrightarrow{f} \Lambda$$

extends to a homomorphism  $F: C_n X \rightarrow \Lambda$ . Since  $F$  vanishes on boundaries, it follows that  $\delta F = 0$ . Let  $x \in H^n X$  denote the cohomology class of the cocycle  $F$ . Then for any  $\xi \in H_n X$  with representative  $\zeta \in Z_n X$ , we have

$$\langle x, \xi \rangle = F(\zeta) = f(\xi) .$$

Thus  $k(x) = f$ , which proves that  $k$  is onto.

*Proof that  $k$  has kernel zero.* Let  $z_0 \in Z^n X$  be such that  $\langle z_0, \zeta \rangle = 0$  for all cycles  $\zeta \in Z_n X$ . We must prove that  $z_0$  is a coboundary.

Since  $z_0$  annihilates cycles, it follows that the composition  $z_0 \partial^{-1}: B_{n-1} X \rightarrow \Lambda$  is well defined. Since the quotient

$$Z_{n-1} X / B_{n-1} X = H_{n-1} X$$

is assumed to be free, it follows that  $B_{n-1} X$  is a direct summand of  $Z_{n-1} X$ , and hence of  $C_{n-1} X$ . Therefore the homomorphism  $z_0 \partial^{-1}$  can be extended over  $C_{n-1} X$ . Let

$$f: C_{n-1} X \rightarrow \Lambda$$

be such an extension; then

$$\langle \delta f, [\sigma] \rangle = \pm \langle f, \partial[\sigma] \rangle = \pm z_0 \partial^{-1}(\partial[\sigma]) = \pm \langle z_0, [\sigma] \rangle .$$

Thus  $\pm z_0$  is equal to the coboundary of  $f$ , as required. ■

### Homology of a CW-Complex

Let  $K$  be the underlying space of a CW-complex (compare Section 6.1), and let  $K^n \subset K$  denote the  $n$ -skeleton (the union of all cells of dimension  $< n$ ).



LEMMA A.2. *The relative homology group  $H_i(K^n, K^{n-1})$  with coefficients in  $\Lambda$  is zero for  $i \neq n$  and is a free module for  $i = n$  with one generator for each  $n$ -cell of  $K$ .*

It follows by A.1 that the cohomology group  $H^i(K^n, K^{n-1})$  is also zero for  $i \neq n$ .

*Proof.* We assume that the reader is familiar with the basic fact that the homology group  $H_i(\mathbb{R}^n, \mathbb{R}^n - 0)$  is zero for  $i \neq n$ , and is isomorphic to  $\Lambda$  when  $i = n$ . (See for example [Dold, p. 56] and compare A.5 below. Since the unit disk  $D^n$  is a deformation retract of  $\mathbb{R}^n$  and the unit sphere  $S^{n-1}$  is a deformation retract of  $\mathbb{R}^n - 0$ , the group  $H_i(\mathbb{R}^n, \mathbb{R}^n - 0)$  is isomorphic to  $H_i(D^n, S^{n-1})$ , which is computed in [Eilenberg-Steenrod, p. 45] or [Spanier, p. 190].)

Let  $S$  denote a discrete set which consists of one point  $s_E$  from each open  $n$ -cell  $E$  of  $K$ . Then it is not difficult to see that  $K^{n-1}$  is a deformation retract of  $K^n - S$ . Using the exact sequence of the triple  $(K^n, K^n - S, K^{n-1})$ , it follows that

$$H_i(K^n, K^{n-1}) \cong H_i(K^n, K^n - S).$$

By excision this last group is isomorphic to  $H_i(\cup E, \cup(E - s_E))$  where  $\cup E$  denotes the disjoint union of all  $n$ -cells of  $K$ . But the homology of such a disjoint union of open subsets of  $K^n$  is clearly the direct sum of the homology groups  $H_i(E, E - s_E) \cong H_i(\mathbb{R}^n, \mathbb{R}^n - 0)$ , and this last group is free on one generator for  $i = n$  and is zero otherwise. ■

COROLLARY A.3. *The group  $H_i K^n$  is zero for  $i > n$  and is isomorphic to  $H_i K$  for  $i < n$ . Similar statements hold for cohomology.*

*Proof for homology.* Certainly  $H_i K^0 = 0$  for  $i > 0$ . Using the exact sequence

$$H_i K^{n-1} \rightarrow H_i K^n \rightarrow H_i(K^n, K^{n-1}),$$

it follows by induction on  $n$  that  $H_i K^n = 0$  for  $i > n$ . If  $i < n$ , a similar sequence shows that  $H_i K^n \cong H_i K^{n+1}$ , and hence inductively that

$$H_i K^n \cong H_i K^{n+1} \cong H_i K^{n+2} \cong \dots$$

If  $K$  is finite dimensional, this completes the proof. For the general case, it is necessary to appeal to the theorem that  $H_i K$  is isomorphic to the direct limit as  $r \rightarrow \infty$  of  $H_i K^r$ . This is true since every singular simplex of  $K$  is contained in a compact subset, and hence is contained in some  $K^r$ . (Compare [J. H. C. Whitehead, 1949, Section 5(D)].)

*Proof for cohomology.* It follows similarly that the relative group  $H_i(K, K^n)$ , being isomorphic to  $H_i(K^{n+1}, K^n)$ , is zero for  $i \leq n$ . Therefore  $H^i(K, K^n) = 0$  for  $i \leq n$  by A.1, and using the cohomology exact sequence of this pair we see that  $H^i(K) \xrightarrow{\cong} H^i(K^n)$  for  $i < n$ . The proof that  $H^i(K^n) = 0$  for  $i > n$  is completely analogous to the corresponding proof for homology. ■

DEFINITION. The free module  $H_n(K^n, K^{n-1})$  will be called the  $n$ -th *chain group* of the CW-complex  $K$  and will be denoted by  $\mathcal{C}_n K = \mathcal{C}_n(K; \Lambda)$ . Similarly the module

$$H^n(K^n, K^{n-1}) \cong \text{Hom}_\Lambda(\mathcal{C}_n K, \Lambda)$$

will be called the  $n$ -th *cochain group*, and will be denoted by  $\mathcal{C}^n K$ .

A "boundary" homomorphism  $\partial_n: \mathcal{C}_{n+1} K \rightarrow \mathcal{C}_n K$  is obtained by using the homology exact sequence of the triple  $(K^{n+1}, K^n, K^{n-1})$ . Similarly  $\delta^n: \mathcal{C}^n K \rightarrow \mathcal{C}^{n+1} K$  is defined.

THEOREM A.4. *The homology group  $\mathcal{Z}_n K / \mathcal{B}_n K$  of the chain complex  $\mathcal{C}_* K$  is canonically isomorphic to  $H_n K$ . Similarly the group  $\mathcal{Z}^n K / \mathcal{B}^n K$  obtained from the cochain complex  $\mathcal{C}^* K$  is canonically isomorphic to  $H^n K$ .*

*Proof.* Consider the following commutative diagram

$$\begin{array}{ccccccc}
 & & 0 & & & & \\
 & & \downarrow & & & & \\
 \mathcal{C}_{n+1} & \longrightarrow & H_n(K^n, K^{n-2}) & \longrightarrow & H_n(K^{n+1}, K^{n-2}) & \longrightarrow & 0 \\
 & \searrow & \downarrow & & & & \\
 & & \mathcal{C}_n & & & & \\
 & & \downarrow & & & & \\
 & & \mathcal{C}_{n-1} & & & & 
 \end{array}$$

The horizontal line is a portion of the homology exact sequence of the triple  $(K^{n+1}, K^n, K^{n-2})$ , and the vertical line is a portion of the exact sequence of  $(K^n, K^{n-1}, K^{n-2})$ . Evidently it follows from this diagram that

$$\mathcal{Z}_n \cong H_n(K^n, K^{n-2})$$

and

$$\mathcal{Z}_n / \mathcal{B}_n \cong H_n(K^{n+1}, K^{n-2}) .$$

But using A.3 one sees that

$$H_n(K^{n+1}, K^{n-2}) \cong H_n K^{n+1} \cong H_n K .$$

The proof for cohomology is completely analogous. ■

### Cup Products

Given cochains  $c \in C^m X$  and  $c' \in C^n X$ , the product  $cc' = c \cup c' \in C^{m+n} X$  is defined as follows. Let  $\sigma: \Delta^{m+n} \rightarrow X$  be a singular simplex. By the *front*  $m$ -face of  $\sigma$  is meant the composition  $\sigma \circ \alpha_m: \Delta^m \rightarrow X$  where

$$\alpha_m(t_0, \dots, t_m) = (t_0, \dots, t_m, 0, \dots, 0) .$$

Similarly the *back*  $n$ -face of  $\sigma$  is the composition  $\sigma \circ \beta_n$  where

$$\beta_n(t_m, t_{m+1}, \dots, t_{m+n}) = (0, \dots, 0, t_m, t_{m+1}, \dots, t_{m+n}) .$$

Now define  $cc' = c \cup c'$  by the identity

$$\langle cc', [\sigma] \rangle = (-1)^{mn} \langle c, [\sigma \circ \alpha_m] \rangle \cdot \langle c', [\sigma \circ \beta_n] \rangle \in \Lambda .$$

This product operation is bilinear and associative, but is not commutative.

The constant cocycle  $1 \in C^0 X$  serves as identity element. The formula

$$\delta(cc') = (\delta c)c' + (-1)^m c(\delta c')$$

is easily verified. This implies that there is a corresponding product operation  $H^m X \otimes H^n X \rightarrow H^{m+n} X$  of cohomology classes. On the cohomology level the product operation does commute, up to sign. (See for example [Spanier, p. 252].) In fact, for  $a \in H^m X$ ,  $b \in H^n X$ , one has  $ba = (-1)^{mn} ab$ . In dealing with graded groups, this property is called commutativity. Thus we say briefly that the cohomology  $H^* X = (H^0 X, H^1 X, H^2 X, \dots)$  is *commutative as a graded ring*.

Now suppose that one is given a pair of spaces  $X \supset A$ . If the cochain  $c$  belongs to the subset  $C^m(X, A) \subset C^m X$  (that is if  $c[\sigma] = 0$  for every  $\sigma: \Delta^m \rightarrow A \subset X$ ) and if  $c' \in C^n X$ , then clearly  $cc'$  belongs to  $C^{m+n}(X, A)$ . This gives rise to a product operation

$$H^m(X, A) \otimes H^n X \rightarrow H^{m+n}(X, A) .$$

More generally consider two subsets  $A, B \subset X$  which satisfy the following.

**HYPOTHESIS.** Both  $A$  and  $B$  are relatively open when considered as subsets of  $A \cup B$ .

Then one can define a product operation

$$H^m(X, A) \otimes H^n(X, B) \rightarrow H^{m+n}(X, A \cup B)$$

as follows.<sup>1</sup> Let

$$\hat{C}^i(X; A, B) \subset C^i X$$

denote the intersection of the submodules  $C^i(X, A)$  and  $C^i(X, B)$  of  $C^i X$ . Given cochains  $c \in C^m(X, A)$  and  $c' \in C^n(X, B)$ , the product  $cc'$  clearly belongs to this intersection

$$\hat{C}^{m+n}(X; A, B) = C^{m+n}(X, A) \cap C^{m+n}(X, B) .$$

Evidently there is a short exact sequence of cochain complexes

$$0 \rightarrow C^*(X, A \cup B) \rightarrow \hat{C}^*(X; A, B) \rightarrow \hat{C}^*(A \cup B; A, B) \rightarrow 0 .$$

But the right hand cochain complex is acyclic, by [Eilenberg-Steenrod, p. 197] or [Spanier, p. 178]. Hence the inclusion

$$C^*(X, A \cup B) \rightarrow \hat{C}^*(X; A, B)$$

induces isomorphisms of cohomology groups. Therefore one obtains a cup product operation with values in the required cohomology group  $H^{m+n}(X, A \cup B)$ .

### Cohomology of Product Spaces

Let  $R_0^n$  denote the complement of the origin in  $R^n$ . For any space  $X$ , we will prove that

$$H^m X \cong H^{m+n}(X \times R^n, X \times R_0^n) .$$

This isomorphism can best be described by introducing the *cohomology cross product operation*. Suppose that one is given cohomology classes

---

<sup>1</sup> The difficulty here is caused by the fact that

$$C^i(X, A) \cap C^i(X, B) \neq C^i(X, A \cup B)$$

since a singular simplex in  $X$  may lie in  $A \cup B$  without lying either in  $A$  or  $B$ .

$$a \in H^m(X, A), \quad b \in H^n(Y, B)$$

where  $A$  is an open subset of  $X$  and  $B$  is an open subset of  $Y$ . (If  $B$  is vacuous then  $A$  need not be open, and conversely.) Using the projection maps

$$p_1 : (X \times Y, A \times Y) \rightarrow (X, A)$$

$$p_2 : (X \times Y, X \times B) \rightarrow (Y, B)$$

the *cross product* (or *external product*)  $a \times b$  is defined to be the cohomology class

$$(p_1^* a)(p_2^* b) \in H^{m+n}(X \times Y, (A \times Y) \cup (X \times B)) .$$

It will sometimes be convenient to use the abbreviation  $(X, A) \times (Y, B)$  for the pair  $(X \times Y, (A \times Y) \cup (X \times B))$ . As an example of this notation, note that the pair  $(\mathbb{R}^n, \mathbb{R}_0^n)$  can be described as the  $n$ -fold product  $(\mathbb{R}, \mathbb{R}_0) \times \dots \times (\mathbb{R}, \mathbb{R}_0)$ .

We will choose a specific generator  $e^n$  for the free module  $H^n(\mathbb{R}^n, \mathbb{R}_0^n)$ , as follows. Note that  $\mathbb{R}_0 = \mathbb{R} - 0$  can be expressed as a disjoint union  $\mathbb{R}_- \cup \mathbb{R}_+$ . Let  $e \in H^1(\mathbb{R}, \mathbb{R}_0)$  correspond to the identity element  $1 \in H^0 \mathbb{R}_+$  under the excision and coboundary isomorphisms

$$H^0 \mathbb{R}_+ \xleftarrow{\cong} H^0(\mathbb{R}_0, \mathbb{R}_-) \xrightarrow{\delta} H^1(\mathbb{R}, \mathbb{R}_0) ,$$

where  $\delta$  arises from the exact sequence of the triple  $(\mathbb{R}, \mathbb{R}_0, \mathbb{R}_-)$ . Finally let  $e^n \in H^n(\mathbb{R}^n, \mathbb{R}_0^n)$  denote the  $n$ -fold cross product  $e \times \dots \times e$ .

**THEOREM A.5.** *For any pair  $(X, A)$  with  $A$  open in  $X$ , the correspondence  $a \mapsto a \times e^n$  defines an isomorphism*

$$H^m(X, A) \rightarrow H^{m+n}((X, A) \times (\mathbb{R}^n, \mathbb{R}_0^n)) .$$

*Proof.* First note that it is sufficient to consider the case  $n = 1$ . The general case will then follow by induction, using the associative law

$$a \times e^n = (a \times e^{n-1}) \times e .$$

Case 1. Suppose that  $n = 1$  and that  $A$  is vacuous. For fixed  $a \in H^m X$ , one has the diagram

$$\begin{array}{ccccc}
 H^0 R_+ & \longleftarrow & H^0(R_0, R_-) & \xrightarrow{\delta} & H^1(R, R_0) \\
 \downarrow a \times & & \downarrow a \times & & \downarrow a \times \\
 H^m X \cong H^m(X \times R_+) & \xleftarrow{i^*} & H^m(X \times R_0, X \times R_-) & \xrightarrow{\delta'} & H^{m+1}(X \times R, X \times R_0)
 \end{array}$$

which commutes up to sign. The homomorphism  $i^*$  is an excision isomorphism, while  $\delta'$  is taken from the cohomology exact sequence of the triple  $(X \times R, X \times R_0, X \times R_-)$ . It is an isomorphism since both  $X \times R$  and  $X \times R_-$  contain the set  $X \times (\text{constant})$  as deformation retract.

Following the diagram around, we see that  $a \times e \in H^{m+1}(X \times R, X \times R_0)$  is the image of  $a \in H^m X$  under a sequence of isomorphisms. This proves Case 1.

Case 2. Suppose that  $n = 1$  but that  $A$  is non-vacuous. Let  $z \in Z^1(R, R_0)$  be a cocycle which represents the cohomology class  $e$ . Consider the following commutative diagram.

$$\begin{array}{ccccccc}
 0 & \longrightarrow & C^m(X, A) & \longrightarrow & C^m X & \longrightarrow & C^m A \longrightarrow 0 \\
 & & \downarrow \times z & & \downarrow \times z & & \downarrow \times z \\
 0 & \longrightarrow & \hat{C}^{m+1}(X \times R; X \times R_0, A \times R) & \longrightarrow & C^{m+1}(X \times R, X \times R_0) & \longrightarrow & C^{m+1}(A \times R, A \times R_0) \longrightarrow 0.
 \end{array}$$

A straightforward argument shows that the horizontal sequences are exact. Furthermore all of these homomorphisms commute with the coboundary operation:

$$\delta(a \times z) = (\delta a) \times z .$$

Hence there is a corresponding commutative diagram of cohomology groups

$$\begin{array}{ccccccc}
 \dots & \xrightarrow{\delta} & H^m(X, A) & \longrightarrow & H^m X & \longrightarrow & H^m A \xrightarrow{\delta} \dots \\
 & & \downarrow \times e & & \downarrow \times e & & \downarrow \times e \\
 \dots & \xrightarrow{\delta} & H^{m+1}((X, A) \times (R, R_0)) & \longrightarrow & H^{m+1}(X \times R, X \times R_0) & \longrightarrow & H^{m+1}(A \times R, A \times R_0) \xrightarrow{\delta} \dots
 \end{array}$$

(See for example [Spanier, p. 182].) By Case 1, the two right hand vertical arrows are isomorphisms. Hence, by the Five Lemma, the left hand vertical arrow is an isomorphism also.

Thus we have proved Theorem A.5 for the special case  $n = 1$ . As remarked at the beginning of the proof, this implies that the Theorem holds for all  $n$ . ■

Now consider two spaces  $X$  and  $Y$ . The cross product operation gives rise to a homomorphism

$$\times : \bigoplus_{i+j=n} H^i X \otimes H^j Y \rightarrow H^n(X \times Y).$$

We would like to prove that  $\times$  is an isomorphism, but this is not true in complete generality. It is false for example if  $X$  and  $Y$  are real projective planes (using integer coefficients), or if  $X$  and  $Y$  are infinite discrete spaces (using arbitrary coefficients).

**THEOREM A.6.** *Let  $X$  and  $Y$  be CW-complexes such that each  $H^i X$  is a torsion free  $\Lambda$ -module<sup>2</sup> and such that  $Y$  has only finitely many cells in each dimension. Then the direct sum*

$$\bigoplus_{i+j=n} H^i X \otimes H^j Y \text{ maps isomorphically onto } H^n(X \times Y).$$

<sup>2</sup> Of course this hypothesis is automatically satisfied if  $\Lambda$  is a field. The assumption that  $X$  is a CW-complex is not actually necessary, but will serve to simplify the proof.



A similar result can be proved for pairs  $(X, A)$  and  $(Y, B)$ . Results of this type are known as "Künneth Theorems," since the prototype was proved by H. Künneth in 1923. For a sharper version, see [Spanier, p. 247].

*Proof.* First suppose that  $Y$  is a finite CW-complex. Then A.6 will be proved by induction on the number of cells of  $Y$ . Certainly A.6 is true if  $Y$  consists of a single point.

Let  $E$  be an open cell of highest dimension and let  $Y_1 = Y - E$ . Assume inductively that

$$\times' : \bigoplus_{i+j=n} H^i X \otimes H^j Y_1 \rightarrow H^n(X \times Y_1)$$

is an isomorphism. Consider the following diagram, which commutes up to sign

$$\begin{array}{ccccccc} \dots & \longrightarrow & \bigoplus H^i X \otimes H^j Y & \longrightarrow & \bigoplus H^i X \otimes H^j Y_1 & \longrightarrow & \bigoplus H^i X \otimes H^{j+1}(Y, Y_1) \longrightarrow \dots \\ & & \downarrow \times & & \downarrow \times' & & \downarrow \times'' \\ \dots & \longrightarrow & H^n(X \times Y) & \longrightarrow & H^n(X \times Y_1) & \longrightarrow & H^{n+1}(X \times Y, X \times Y_1) \longrightarrow \dots \end{array}$$

Here the top line is obtained from the exact sequence of the pair  $(Y, Y_1)$  by tensoring with  $H^i X$ , and then forming the direct sum over all  $i, j$  with  $i + j = n$ . This remains an exact sequence since  $H^i X$  is torsion free. (Compare [MacLane, p. 152], [Cartan-Eilenberg, p. 133].)

We have assumed that  $\times'$  is an isomorphism. Using A.5 together with the isomorphisms

$$H^j(Y, Y_1) \leftarrow H^j(Y, Y\text{-point}) \rightarrow H^j(E, E\text{-point})$$

and

$$H^n(X \times Y, X \times Y_1) \leftarrow H^n(X \times Y, X \times (Y\text{-point})) \rightarrow H^n(X \times E, X \times (E\text{-point}))$$

we see that  $\times''$  is also an isomorphism. Therefore, by the Five Lemma,  $\times$  is an isomorphism. This completes the proof, providing that  $Y$  is finite. (We have not yet used the hypothesis that  $X$  is a CW-complex.)

If  $Y$  is infinite but each skeleton  $Y^r$  is finite, then the above argument applies to  $X \times Y^r$ . But it follows easily from A.3 that the inclusions

$$Y^r \rightarrow Y, \quad X \times Y^r \rightarrow X \times Y$$

induce isomorphism of cohomology in dimensions less than  $r$ . Thus A.6 is true for  $n < r$ . Since  $r$  can be arbitrarily large this completes the proof. ■

### Homology of Manifolds

We will now prove some preliminary results which will be needed to construct the fundamental homology class of a manifold, and to prove the Poincaré Duality Theorem. (Compare Section 11.5.)

Let  $M$  be a fixed  $n$ -dimensional manifold, not necessarily compact. We will first study the groups  $H_i(M, M-K)$  where  $K$  denotes a compact subset of  $M$ . If  $K \subset L \subset M$ , then the natural homomorphism

$$H_i(M, M-L) \rightarrow H_i(M, M-K)$$

will be denoted by  $\rho_K$ . The image  $\rho_K(\alpha)$  will be thought of as the "restriction" of  $\alpha$  to  $K$ .

**LEMMA A.7.** *The groups  $H_i(M, M-K)$  are zero for  $i > n$ . A homology class  $\alpha \in H_n(M, M-K)$  is zero if and only if the restriction*

$$\rho_x(\alpha) \in H_n(M, M-x)$$

*is zero for each  $x \in K$ .*

The proof will be divided into six steps.

**Case 1.** Suppose that  $M = \mathbb{R}^n$  and that  $K$  is a compact convex subset.

Let  $x$  be a point of  $K$ , and let  $S$  be a large  $(n-1)$ -sphere with center  $x$ . Then  $S$  is a deformation retract of both  $\mathbb{R}^n - x$  and of  $\mathbb{R}^n - K$ .

From this one sees that

$$H_i(\mathbb{R}^n, \mathbb{R}^n - K) \xrightarrow{\cong} H_i(\mathbb{R}^n, \mathbb{R}^n - x)$$

for all  $i$ , which completes the proof in Case 1.

Case 2. Suppose that  $K = K_1 \cup K_2$  where the lemma is known to be true for  $K_1$ ,  $K_2$ , and for  $K_1 \cap K_2$ .

We will make use of the relative Mayer-Vietoris sequence

$$\dots \rightarrow H_{i+1}(M, M - (K_1 \cap K_2)) \xrightarrow{\delta} H_i(M, M - K) \xrightarrow{s} H_i(M, M - K_1) \oplus H_i(M, M - K_2) \rightarrow \dots,$$

where the homomorphism  $s$  is defined by

$$s(\alpha) = \rho_{K_1}(\alpha) \oplus \rho_{K_2}(\alpha).$$

(See for example [Eilenberg-Steenrod, p. 42] or [Spanier, p. 187].) Assuming the existence of such a sequence, the proof in Case 2 can easily be completed. Details will be left to the reader.

Here is a brief construction of the sequence. Let  $U_j$  denote the open set  $M - K_j$ . In analogy with the discussion on p. 265, let  $\hat{C}_i(M; U_1, U_2)$  denote the quotient  $C_i M / (C_i U_1 + C_i U_2)$  where  $C_i U_1 + C_i U_2 \subset C_i(U_1 \cup U_2)$  denotes the free module generated by all singular  $i$ -simplexes which lie either in  $U_1$  or in  $U_2$ . Then the natural homomorphism

$$\hat{C}_*(M; U_1, U_2) \rightarrow C_*(M, U_1 \cup U_2)$$

induces isomorphisms of homology groups. (Compare the argument on p. 265.) Now the commutative diagram

$$\begin{array}{ccc}
 & & C_i(M, U_1) \\
 & \nearrow & \searrow \\
 C_i(M, U_1 \cup U_2) & & \hat{C}_i(M; U_1, U_2) \\
 & \searrow & \nearrow \\
 & & C_i(M, U_2)
 \end{array}$$

gives rise to a short exact sequence

$$0 \longrightarrow C_i(M, U_1 \cap U_2) \xrightarrow{\text{sum}} C_i(M, U_1) \oplus C_i(M, U_2) \xrightarrow{\text{difference}} \hat{C}_i(M; U_1, U_2) \longrightarrow 0 .$$

The associated long exact sequence of homology groups is the required relative Mayer-Vietoris sequence.

*Case 3.*  $K \subset \mathbb{R}^n$  is a finite union  $K_1 \cup \dots \cup K_r$  of compact, convex sets.

Then the lemma can be proved by induction on  $r$ , making use of Cases 1 and 2.

*Case 4.*  $K$  is an arbitrary compact subset of  $\mathbb{R}^n$ .

Given  $\alpha \in H_i(\mathbb{R}^n, \mathbb{R}^n - K)$ , choose a compact neighborhood  $N$  of  $K$  and a class  $\alpha' \in H_i(\mathbb{R}^n, \mathbb{R}^n - N)$  so that  $\rho_K(\alpha') = \alpha$ . This is possible since we can choose a chain  $\gamma \in C_i \mathbb{R}^n$  whose image modulo  $\mathbb{R}^n - K$  is a cycle representing  $\alpha$ . Then the boundary of  $\gamma$  is "supported" by a compact set disjoint from  $K$ . We need only choose  $N$  small enough to be disjoint from this support.

Cover  $K$  by finitely many closed balls  $B_1, \dots, B_r$  such that  $B_i \subset N$  and  $B_i \cap K \neq \emptyset$ . If  $i > n$  then  $\rho_{B_1 \cup \dots \cup B_r} \alpha' = 0$  by Case 3, hence  $\alpha = 0$ . If  $i = n$  and  $\rho_x(\alpha) = 0$  for each  $x \in K$ , then clearly  $\rho_x(\alpha') = 0$  for each  $x \in B_1 \cup \dots \cup B_r$ . (Compare Case 1.) Hence again  $\rho_{B_1 \cup \dots \cup B_r}(\alpha') = 0$  and therefore  $\alpha = 0$ .

*Case 5.*  $K \subset M$  is small enough so as to have a neighborhood  $U$  homeomorphic to  $\mathbb{R}^n$ .

Since  $H_*(M, M - K) \cong H_*(U, U - K)$  by excision, the assertion in this case follows from Case 4.

*Case 6.*  $K \subset M$  is arbitrary.

Then  $K = K_1 \cup \dots \cup K_r$  where each  $K_j$  is "small" as in Case 5. The proof now proceeds by induction on  $r$ , using Case 2. This completes the proof of A.7. ■

### The Fundamental Homology Class of a Manifold

We will now use the infinite cyclic group  $\mathbb{Z}$  as coefficient domain.

For each  $x \in M$ , recall that

$$H_i(M, M-x; \mathbb{Z}) \cong H_i(\mathbb{R}^n, \mathbb{R}^n - 0; \mathbb{Z})$$

is infinite cyclic for  $i = n$  and is zero for  $i \neq n$ .

**DEFINITION.** A *local orientation*  $\mu_x$  for  $M$  at  $x$  is a choice of one of the two possible generators for  $H_n(M, M-x; \mathbb{Z})$ .

Note that such a  $\mu_x$  determines local orientations  $\mu_y$  for all points  $y$  in a small neighborhood of  $x$ . To be more precise, if  $B$  is a ball about  $x$  (in terms of some local coordinate system), then for each  $y \in B$  the isomorphisms

$$H_*(M, M-x) \xleftarrow{\rho_x} H_*(M, M-B) \xrightarrow{\rho_y} H_*(M, M-y)$$

determine a local orientation  $\mu_y$ .

**DEFINITION.** An *orientation* for  $M$  is a function which assigns to each  $x \in M$  a local orientation  $\mu_x$  which "varies continuously" with  $x$ , in the following sense: For each  $x$  there should exist a compact neighborhood  $N$  and a class  $\mu_N \in H_n(M, M-N)$  so that  $\rho_y(\mu_N) = \mu_y$  for each  $y \in N$ .

The pair consisting of manifold and orientation is called an *oriented manifold*.

**THEOREM A.8.** For any oriented manifold  $M$  and any compact  $K \subset M$ , there is one and only one class  $\mu_K \in H_n(M, M-K)$  which satisfies  $\rho_x(\mu_K) = \mu_x$  for each  $x \in K$ .

In particular, if  $M$  itself is compact, then there is one and only one  $\mu_M \in H_n M$  with the required property. This class  $\mu = \mu_M$  is called the *fundamental homology class* of  $M$ .

*Proof of A.8.* The uniqueness of  $\mu_K$  follows immediately from A.7. The existence proof will be divided into three steps.

Case 1. If  $K$  is contained in a sufficiently small neighborhood of some given point, then the existence of  $\mu_K$  follows from the definition of orientation.

Case 2. Suppose that  $K = K_1 \cup K_2$  where  $\mu_{K_1}$  and  $\mu_{K_2}$  exist. As in A.7 there is an exact sequence

$$\dots \rightarrow 0 \rightarrow H_n(M, M-K) \xrightarrow{s} H_n(M, M-K_1) \oplus H_n(M, M-K_2) \xrightarrow{t} H_n(M, M-K_1 \cap K_2) \rightarrow \dots$$

where

$$s(a) = \rho_{K_1}(a) \oplus \rho_{K_2}(a) ,$$

$$t(\beta \oplus \gamma) = \rho_{K_1 \cap K_2}(\beta) - \rho_{K_1 \cap K_2}(\gamma) .$$

Now  $t(\mu_{K_1} \oplus \mu_{K_2}) = 0$ , by the uniqueness theorem applied to  $K_1 \cap K_2$ , hence  $\mu_{K_1} \oplus \mu_{K_2} = s(a)$  for some unique  $a \in H_n(M, M-K)$ . This  $a$  is the required  $\mu_K$ .

Case 3.  $K$  arbitrary. Then  $K = K_1 \cup \dots \cup K_r$  where the  $\mu_{K_i}$  exist by Case 1. The class  $\mu_K$  is now constructed by induction on  $r$ . ■

REMARK 1. For any coefficient domain  $\Lambda$ , the unique homomorphism  $Z \rightarrow \Lambda$  gives rise to a class in  $H_n(M, M-K; \Lambda)$  which will also be denoted by  $\mu_K$ . The case  $\Lambda = Z/2$  is particularly important, since the mod 2 homology class

$$\mu_K \in H_n(M, M-K; Z/2)$$

can be constructed directly for an arbitrary manifold, without making any assumption of orientability.

REMARK 2. Similar considerations apply to an oriented manifold-with-boundary  $M$ . For each compact subset  $K \subset M$ , there exists a unique class  $\mu_K \in H_n(M, (M-K) \cup \partial M)$  with the property that  $\rho_X(\mu_K) = \mu_X$  for

each  $x \in K \cap (M - \partial M)$ . In particular, if  $M$  is compact, then there is a unique fundamental homology class  $\mu_M \in H_n(M, \partial M)$  with the required property. It can be shown that the natural homomorphism

$$\partial : H_n(M, \partial M) \rightarrow H_{n-1}(\partial M)$$

maps  $\mu_M$  to the fundamental homology class of  $\partial M$ . (Compare [Spanier, p. 304].)

### Cohomology with Compact Support

A cochain  $c \in C^i M$  is said to have *compact support* if there exists a compact set  $K \subset M$  so that  $c$  belongs to the submodule  $C^i(M, M - K) \subset C^i M$ . In other words  $c$  must annihilate every singular simplex in  $M - K$ . The cochains with compact support form a submodule which will be denoted by  $C_{\text{comp}}^i M \subset C^i M$ . The cohomology groups of this complex  $C_{\text{comp}}^* M$  will be denoted by  $H_{\text{comp}}^i M$ . A straightforward argument [Spanier, p. 162] shows that  $H_{\text{comp}}^i M$  is isomorphic to the direct limit of the groups  $H^i(M, M - K)$  as  $K$  varies over the directed set consisting of all compact subsets of  $M$ . If  $M$  is compact, note that  $H_{\text{comp}}^i M \cong H^i M$ .

If  $M$  is oriented, then there is an important homomorphism

$$H_{\text{comp}}^n M \rightarrow \Lambda$$

which will be denoted by  $a \mapsto a[M]$ , and called *integration over  $M$* .

When  $M$  is compact, this can be defined by

$$a[M] = \langle a, \mu_M \rangle \in \Lambda .$$

In the general case it is necessary to choose some representative  $a' \in H^n(M, M - K)$  for  $a$ , and then to define

$$a[M] = \langle a', \mu_K \rangle .$$

The reader should verify that this definition does not depend on the choice of  $K$  and  $a'$ .

### The Cap Product Operation

For any space  $X$  and any coefficient domain, there is a bilinear pairing operation

$$\cap : C^i X \otimes C_n X \rightarrow C_{n-i} X$$

which can be characterized as follows. For each cochain  $b \in C^i X$  and each chain  $\xi \in C_n X$  the cap product  $b \cap \xi$  is the unique element of  $C_{n-i} X$  such that

$$(1) \quad \langle a, b \cap \xi \rangle = \langle ab, \xi \rangle$$

for all  $a \in C^{n-i} X$ . More explicitly, for each generator  $[\sigma]$  of  $C_n X$ , the cap product  $b \cap [\sigma]$  can be defined as the product of the ring element  $(-1)^{i(n-i)} \langle b, [\text{back } i\text{-face of } \sigma] \rangle$  with the singular simplex  $[\text{front } (n-i)\text{-face of } \sigma]$ .

Combining the identity (1) with the standard properties of cup products, one can derive the following rules:

$$(2) \quad (bc) \cap \xi = b \cap (c \cap \xi)$$

$$(3) \quad 1 \cap \xi = \xi$$

$$(4) \quad \partial(b \cap \xi) = (\delta b) \cap \xi + (-1)^{\dim b} b \cap \partial \xi .$$

From (4) it follows that there is a corresponding operation

$$H^i X \otimes H_n X \rightarrow H_{n-i} X$$

which will also be denoted by  $\cap$ .

In terms of this operation we can now state the duality theorem for compact manifolds, using any coefficient domain.

**POINCARÉ DUALITY THEOREM.** *If  $M$  is compact and oriented, then  $H^i M$  is isomorphic to  $H_{n-i} M$  under the correspondence  $a \mapsto a \cap \mu_M$ .*



For a non-orientable manifold the duality theorem is still true, but only if one uses the coefficient domain  $\mathbb{Z}/2$ .

The proof will involve a more general situation. First observe that for any pair  $(X, A)$ , the cap product gives rise to a pairing

$$C^i(X, A) \otimes C_n(X, A) \rightarrow C_{n-i}X$$

and hence to a pairing

$$\cap : H^i(X, A) \otimes H_n(X, A) \rightarrow H_{n-i}X .$$

(In even greater generality one can define

$$\cap : H^i(X, A) \otimes H_n(X, A \cup B) \rightarrow H_{n-i}(X, B)$$

if  $A$  and  $B$  are open in  $A \cup B$ .) Now let  $M$  be oriented but not necessarily compact. Define the duality map

$$D : H_{\text{comp}}^i M \rightarrow H_{n-i}M$$

as follows. For any  $a \in H_{\text{comp}}^i M = \varinjlim H^i(M, M-K)$  choose a representative  $a' \in H^i(M, M-K)$  and set

$$D(a) = a' \cap \mu_K .$$

This is well defined since, for  $K \subset L$ , the diagram

$$\begin{array}{ccc} H^i(M, M-K) & \xrightarrow{\quad} & H^i(M, M-L) \\ & \searrow \cap \mu_K & \swarrow \cap \mu_L \\ & H_{n-i}M & \end{array}$$

is clearly commutative. In the special case where  $M$  is compact, note that  $D(a) = a \cap \mu_M$ .

DUALITY THEOREM A.9. *The homomorphism  $D$  maps  $H_{\text{comp}}^i M$  isomorphically onto  $H_{n-i} M$ .*

If  $M$  is compact, then this implies that  $\cap \mu_M$  maps  $H^i M$  isomorphically onto  $H_{n-i} M$ , as previously asserted.

The proof will be divided into five cases.

Case 1. Suppose that  $M = \mathbb{R}^n$ .

Given any ball  $B$  we clearly have  $H_n(\mathbb{R}^n, \mathbb{R}^n - B) \cong \Lambda$  with generator  $\mu_B$ . (Compare A.7, Case 1.) Hence  $H^n(\mathbb{R}^n, \mathbb{R}^n - B) \cong \Lambda$  by A.1, with a generator  $a$  such that  $\langle a, \mu_B \rangle = 1$ . Now the identity

$$\langle 1a, \mu_B \rangle = \langle 1, a \cap \mu_B \rangle$$

shows that  $a \cap \mu_B$  is a generator of  $H_0 \mathbb{R}^n \cong \Lambda$ . Thus  $\cap \mu_B$  maps  $H^*(\mathbb{R}^n, \mathbb{R}^n - B)$  isomorphically to  $H_*(\mathbb{R}^n)$ , and passing to the direct limit as  $B$  becomes larger it follows that the homomorphism  $D$  maps  $H_{\text{comp}}^*(\mathbb{R}^n)$  isomorphically onto  $H_*(\mathbb{R}^n)$ .

Case 2. Suppose that  $M = U \cup V$  where the theorem is true for the open subsets  $U, V$  and  $U \cap V$ .

We will construct a commutative diagram

$$\begin{array}{ccccccc} \dots & \xrightarrow{\delta} & H_{\text{comp}}^i(U \cap V) & \longrightarrow & H_{\text{comp}}^i U \oplus H_{\text{comp}}^i V & \longrightarrow & H_{\text{comp}}^i M \xrightarrow{\delta} \dots \\ & & \downarrow D & & \downarrow D & & \downarrow D \\ \dots & \xrightarrow{\partial} & H_{n-i}(U \cap V) & \longrightarrow & H_{n-i} U \oplus H_{n-i} V & \longrightarrow & H_{n-i} M \xrightarrow{\partial} \dots \end{array}$$

where the bottom line is a Mayer-Vietoris sequence [Eilenberg-Steenrod, p. 37]. The construction of the bottom sequence is similar to that in the proof of A.7. To construct the top exact sequence, note that for each compact  $K \subset U$  and  $L \subset V$  there is a relative Mayer-Vietoris sequence

$$\dots \xrightarrow{\delta} H^i(M, M - K \cap L) \longrightarrow H^i(M, M - K) \oplus H^i(M, M - L) \longrightarrow H^i(M, M - K \cup L) \longrightarrow \dots ,$$

as in the proof of A.7. By excision this can be rewritten as

$$\dots \xrightarrow{\delta} H^i(U \cap V, U \cap V - K \cap L) \rightarrow H^i(U, U - K) \oplus H^i(V, V - L) \rightarrow H^i(M, M - K \cup L) \rightarrow \dots$$

Now passing to the direct limit as  $K$  and  $L$  become larger we obtain the required sequence.

Applying the Five Lemma to the resulting diagram, this completes the proof in Case 2.

Case 3.  $M$  is the union of a nested family of open sets  $U_\alpha$ , where the duality theorem is true for each  $U_\alpha$ .

Then  $H_{\text{comp}}^i M = \varinjlim H_{\text{comp}}^i U_\alpha$  and  $H_{n-i} M = \varinjlim H_{n-i} U_\alpha$ . (Both assertions follow easily from the fact that every compact subset of  $M$  is contained in some  $U_\alpha$ .) Since the direct limit of isomorphisms is an isomorphism, this completes the proof in Case 3.

Case 4.  $M$  is an open subset of  $\mathbb{R}^n$ .

If  $M$  is convex, then it is homeomorphic to  $\mathbb{R}^n$ , so the statement follows from Case 1. More generally choose convex open sets  $V_1, V_2, V_3, \dots$  with union  $M$ . Using Case 2 inductively, the theorem is true for each  $V_1 \cup V_2 \cup \dots \cup V_k$ . Passing to the direct limit as  $k \rightarrow \infty$ , it is true for  $M$ .

Case 5.  $M$  is arbitrary.

Cover  $M$  by open sets  $V_\alpha$ , each diffeomorphic to an open subset of  $\mathbb{R}^n$ , and choose a well ordering of the index set. (If  $M$  has a countable basis, then we can use the positive integers as index set.) Now a straightforward transfinite induction, using Cases 2, 3, and 4, shows that the theorem is true for each partial union  $U_{\alpha < \beta} V_\alpha$ . Hence, by Case 3, it is true for  $M$ . ■

Here are two concluding problems for the reader.

*Problem A-1.* For an oriented manifold-with-boundary construct the duality isomorphism

$$H_{\text{comp}}^i M \rightarrow H_{n-i}(M, \partial M) .$$

Alternatively, defining  $H_{\text{comp}}^i(M, \partial M) = \varinjlim H^i(M, (M-K) \cup \partial M)$ , construct the isomorphism

$$H_{\text{comp}}^i(M, \partial M) \rightarrow H_{n-i} M .$$

*Problem A-2 (Alexander duality).* Let  $K$  be a compact subset of the sphere  $S^n$  which is a retract of some neighborhood. (This hypothesis is needed since we are using singular, rather than Čech, cohomology.) Show that  $H^i K$  is isomorphic to the direct limit  $\varinjlim H^i U$  as  $U$  ranges over all neighborhoods of  $K$ . Show that  $H^i(S^n, K)$  is isomorphic to

$$\varinjlim H^i(S^n, U) \cong H_{\text{comp}}^i(S^n - K) \cong H_{n-i}(S^n - K) .$$

Finally, given  $x \in K$  and  $y \in S^n - K$ , show that

$$H^{i-1}(K, x) \cong H_{n-i}(S^n - K, y) .$$

•

## Appendix B: Bernoulli Numbers

Since the appearance of Hirzebruch's signature theorem and his generalized Riemann-Roch theorem, it has become useful for topologists to know something about Bernoulli numbers and their number theoretic properties. This appendix will describe some of these properties.

The Bernoulli numbers  $B_1, B_2, \dots$  can be defined as the coefficients which occur in the power series expansion

$$\frac{x}{\tanh x} = \frac{x \cosh x}{\sinh x} = 1 + \frac{B_1}{2!} (2x)^2 - \frac{B_2}{4!} (2x)^4 + \frac{B_3}{6!} (2x)^6 - + \dots$$

(convergent for  $|x| < \pi$ ), or equivalently in the expansion

$$\frac{z}{e^z - 1} = 1 - \frac{z}{2} + \frac{B_1}{2!} z^2 - \frac{B_2}{4!} z^4 + \frac{B_3}{6!} z^6 - + \dots .$$

These two series are related by the easily verified identity

$$\frac{x}{\tanh x} = \frac{2x}{e^{2x} - 1} + x .$$

With this notation one has:

$$B_1 = \frac{1}{6}, B_2 = \frac{1}{30}, B_3 = \frac{1}{42}, B_4 = \frac{1}{30}, B_5 = \frac{5}{66}, B_6 = \frac{691}{2730}, B_7 = \frac{7}{6}, B_8 = \frac{3617}{510} ,$$

and so on. (The reader should beware since other conflicting notations are also in common usage.) These numbers were first introduced by Jakob Bernoulli, the oldest of that famous family of mathematicians, in a work published posthumously in 1713. They can be computed for example by actually dividing the appropriate power series, or by a procedure based on the proof of Lemma B.1 below.

Many related classical power series expansions can be derived from these. For example the identity

$$\frac{1}{\sinh 2x} = \frac{1}{\tanh x} - \frac{1}{\tanh 2x}$$

leads to the series

$$\frac{u}{\sinh u} = 1 - (2^2-2) \frac{B_1}{2!} u^2 + (2^4-2) \frac{B_2}{4!} u^4 - + \dots$$

(compare Problem 19-C), and the identity

$$\tanh x = \frac{2}{\tanh 2x} - \frac{1}{\tanh x}$$

leads to the series

$$\tanh x = 2^2(2^2-1) \frac{B_1}{2!} x - 2^4(2^4-1) \frac{B_2}{4!} x^3 + - \dots$$

Closely related, by means of the equation  $\tanh iy = i \tan y$ , is the series

$$\tan y = 2^2(2^2-1) \frac{B_1}{2!} y + 2^4(2^4-1) \frac{B_2}{4!} y^3 + \dots$$

This last can be used to prove an interesting number theoretic property.

**LEMMA B.1.** *For each  $n$  the number  $2^{2n}(2^{2n}-1)B_n/2n$  is a positive integer.*

For the above Taylor expansion shows that  $2^{2n}(2^{2n}-1)B_n/2n$  is equal to the  $(2n-1)$ -st derivative of  $\tan y$  at the origin. But the identity

$$d \tan^m y / dy = m(\tan^{m-1} y + \tan^{m+1} y)$$

together with a straightforward induction shows that the  $(2n-1)$ -st derivative of  $\tan y$  equals

$$a_{n0} + a_{n1} \tan^2 y + \dots + a_{nn} \tan^{2n} y$$

where the coefficients  $a_{n0}, a_{n1}, \dots, a_{nn}$  are positive integers. In particular the value  $a_{n0}$  at the origin is a positive integer. ■

More generally one has the following.

LEMMA B.2 (Lipschitz-Sylvester). *For any integer  $k$ , the expression  $k^{2n}(k^{2n}-1)B_n/2n$  is an integer.*

*Proof.* Consider the function  $f(x) = 1 + e^x + e^{2x} + \dots + e^{(k-1)x} = (e^{kx}-1)/(e^x-1)$ . Note that  $f(0) = k$ , and that the derivatives of  $f$  at zero are all integers. Now consider the logarithmic derivative

$$f'(x)/f(x) = \frac{d}{dx}(\log(e^{kx}-1) - \log(e^x-1)) = (ke^{kx}/(e^{kx}-1)) - e^x/(e^x-1) .$$

Using the Taylor expansion

$$\frac{e^x}{e^x-1} = \frac{1}{x} \frac{-x}{(e^{-x}-1)} = \frac{1}{x} \left( 1 + \frac{x}{2} + \frac{B_1}{2!} x^2 - \frac{B_2}{4!} x^4 + \dots \right) ,$$

we obtain

$$f'(x)/f(x) = (k-1)/2 + (k^2-1) \frac{B_1}{2!} x - (k^4-1) \frac{B_2}{4!} x^3 + \dots .$$

Therefore the  $(2n-1)$ -st derivative of  $f'(x)/f(x)$  at the origin is equal to  $\pm(k^{2n}-1)B_n/2n$ . A straightforward induction shows that this derivative can be expressed as a polynomial in  $f(x), f'(x), \dots, f^{(2n)}(x)$  with integer coefficients, divided by  $(f(x))^{2n}$ . Setting  $x = 0$ , this yields

$$(k^{2n}-1)B_n/2n = (\text{integer})/k^{2n} ,$$

as required. ■

The following two theorems give more precise number theoretic information. The first was proved independently by T. Clausen and K. G. C. von Staudt in 1840.

**THEOREM B.3.** *The rational number  $(-1)^n B_n$  is congruent modulo  $\mathbb{Z}$  to  $\sum (1/p)$ , to be summed over all primes  $p$  such that  $p-1$  divides  $2n$ . Hence the denominator of  $B_n$ , expressed as a fraction in lowest terms, is equal to the product of all primes  $p$  with  $(p-1) \mid 2n$ .*

Thus the denominator of  $B_n$  is always square free and divisible by 6. It is divisible by a prime  $p > 3$  if and only if  $n$  is a multiple of  $(p-1)/2$ . For a proof the reader is referred to [Hardy and Wright, Section 7.10] or [Borevich and Shafarevich, p. 384]. ■

The next result was proved by von Staudt in 1845.

**THEOREM B.4.** *A prime divides the denominator of  $B_n/n$  (expressed as a fraction in lowest terms) if and only if it divides the denominator of  $B_n$ .*

It is now easy to compute the denominator of  $B_n/n$  explicitly. For any prime  $p$  with  $(p-1) \mid 2n$ , let  $p^\mu$  be the highest power of  $p$  dividing  $n$ . Then clearly  $p^{\mu+1}$  is the highest power of  $p$  dividing the denominator of  $B_n/n$ . As an example, for  $n = 14$  since the primes 2, 3, 5, 29 are the only ones satisfying  $(p-1) \mid 2n$ , it follows that the denominator of  $B_{14}/14$  is equal to  $2^2 \cdot 3 \cdot 5 \cdot 29$ .

**REMARK.** This computation is of interest to homotopy theorists, in view of the theorem that the image of the stable J-homomorphism

$$J : \pi_{4n-1} \text{SO}_N \rightarrow \pi_{4n-1+N}(\mathbb{S}^N)$$

is a cyclic group of order equal to the denominator of  $B_n/4n$ . (Compare [Milnor and Kervaire, 1958], [Adams, 1965], and [Mahowald].)

*Proof of B.4.* Let  $p$  be an arbitrary prime. If  $p$  divides the denominator of  $B_n$ , then it certainly divides the denominator of  $B_n/n$ . If  $p$



does not divide the denominator of  $B_n$ , then  $2n \not\equiv 0 \pmod{p-1}$  by B.3. Choose a primitive root  $k$  modulo  $p$ , that is, choose  $k$  so that  $k^r \equiv 1 \pmod{p}$  if and only if  $r$  is a multiple of  $p-1$ . Then

$$k^{2n} \not\equiv 1 \pmod{p},$$

hence the integer  $k^{2n}(k^{2n}-1)/2$  is relatively prime to  $p$ . Therefore  $B_n/n$ , being equal to the integer  $k^{2n}(k^{2n}-1)B_n/2n$  divided by  $k^{2n}(k^{2n}-1)/2$ , has denominator prime to  $p$ . ■

The numerator of the fraction  $B_n/n$  is much more difficult to compute. For small values of  $n$  it can be tabulated as follows.

$n$	$\leq 5$	6	7	8	9	10	11	12
numerator $\left(\frac{B_n}{n}\right)$	1	691	1	3617	43867	174611	77683	236364091

REMARK. This numerator is of interest to differential topologists in view of the theorem that the group consisting of all diffeomorphism classes of exotic  $(4n-1)$ -spheres which bound parallelizable manifolds is a cyclic group of order

$$2^{2n-2}(2^{2n-1}-1) \text{ numerator } (4B_n/n)$$

for  $n \geq 2$ . (See [Kervaire and Milnor, 1963].) It is of interest in number theory since Kummer, in 1850, proved Fermat's last theorem for any prime exponent  $p$  which *does not* divide the numerator of any  $B_n/n$ . (See [Borevich-Shafarevich].) Such primes are called "regular." The smallest irregular prime is 37, which divides the numerator 7709321041217 of  $B_{16}$ . If two integers  $m$  and  $n$  satisfy  $m \equiv n \not\equiv 0 \pmod{(p-1)/2}$  for some odd prime  $p$ , then Kummer showed that  $p$  divides the numerator of

$$(-1)^m B_m/m - (-1)^n B_n/n.$$

Therefore, in order to test a given prime  $p$  for regularity, it suffices to examine the numerators of those  $B_n$  with  $1 \leq n < (p-1)/2$ .

The numerator of  $B_n/n$  is non-trivial for all  $n \geq 8$ , and grows very rapidly with  $n$ . To see this, recall the famous formula

$$1 + \frac{1}{2^{2n}} + \frac{1}{3^{2n}} + \frac{1}{4^{2n}} + \dots = B_n(2\pi)^{2n}/2(2n)!$$

of Euler. (See Problem B-4 below.) Using Stirling's formula

$$1 < \frac{m!}{m^m e^{-m} \sqrt{2\pi m}} < e^{1/12m}$$

(see [Artin]), this implies that

$$B_n > 2(2n)!/(2\pi)^{2n} > 4 \left(\frac{n}{\pi e}\right)^{2n} \sqrt{\pi n}$$

(where all three expressions are asymptotically equal as  $n \rightarrow \infty$ ). Therefore

$$\text{numerator} \left(\frac{B_n}{n}\right) > \frac{B_n}{n} > \frac{4}{\sqrt{e}} \left(\frac{n}{\pi e}\right)^{2n - \frac{1}{2}} > 1$$

for all  $n > \pi e = 8.539\dots$

For further information concerning Bernoulli numbers, the reader is referred to [Nielsen] or [Borevich-Shafarevich].

We conclude with some exercises.

*Problem B-1* (J. F. Adams). If all of the prime factors of  $n$  have the form  $6k+1$ , show that the denominator of  $B_n/n$  is equal to 6.

*Problem B-2* (J. F. Adams). Given constants  $N > \log_2(4n)$  show that the greatest common divisor of the integers

$$2^N(2^{2n}-1), 3^N(3^{2n}-1), 4^N(4^{2n}-1), \dots$$

is equal to the denominator of  $B_n/4n$ .

*Problem B-3*. Let  $D = \frac{d}{dt}$  denote the differentiation operator  $f(t) \mapsto f'(t)$  applied to any polynomial  $f(t)$ . Show that the operator

$e^D = 1 + D + \frac{1}{2!} D^2 + \dots$  maps  $f(t)$  to  $f(t+1)$ , and show that the operator

$$\frac{D}{e^D - 1} = 1 - \frac{1}{2} D + \frac{B_1}{2!} D^2 - + \dots$$

maps  $f(t)$  to a polynomial  $g(t) = f(t) - \frac{1}{2} f'(t) + \frac{B_1}{2!} f''(t) - \frac{B_2}{4!} f'''(t) + \dots$  which satisfies the difference equation

$$g(t+1) - g(t) = f'(t) .$$

In this way prove the Euler-Maclaurin summation formula

$$f'(0) + f'(1) + \dots + f'(k-1) = g(k) - g(0) .$$

*Problem B-4.* Taking  $f(t) = t^m/m!$ , the corresponding polynomial

$$g(t) = t^m/m! - \frac{1}{2} t^{m-1}/(m-1)! + \frac{B_1}{2!} t^{m-2}/(m-2)! - + \dots$$

may be called the  $m$ -th "Bernoulli polynomial"  $p_m(t)$ . Show that these Bernoulli polynomials can be characterized inductively, starting with  $p_0(t) = 1$ , by the property that each  $p_m(t)$ ,  $m \geq 1$ , is an indefinite integral of  $p_{m-1}(t)$  and satisfies  $\int_0^1 p_m(t) dt = 0$ . Compute the integral

$$\int_0^1 p_m(t) e^{-2\pi i k t} dt = -1/(2\pi i k)^m$$

inductively, for  $k \neq 0$ ,  $m \geq 1$ , using integration by parts, and hence establish the uniformly convergent Fourier series expansion

$$p_m(t) = - \sum_{k \neq 0} e^{2\pi i k t} / (2\pi i k)^m$$

for  $m \geq 2$ ,  $0 \leq t \leq 1$ . Evaluating at  $t = 0$ , prove Euler's formula

$$B_n/(2n)! = 2 \sum_{k=1}^{\infty} 1/(2\pi k)^{2n} .$$

## Appendix C: Connections, Curvature, and Characteristic Classes

This appendix will outline the Chern-Weil description of Characteristic classes with real or complex coefficients in terms of curvature forms. (Compare [Chern] or [Bott-Chern, Section 2].) We will assume that the reader is familiar with the rudiments of exterior differential calculus and de Rham cohomology, as developed for example in [Warner]. However our sign conventions, as described in Appendix A, are different from those of Warner and other authors. We will return to this point later.

We begin with the case of a complex vector bundle. Let  $\zeta$  be a smooth complex  $n$ -plane bundle with smooth base space  $M$ , and let

$$\tau_{\mathbb{C}}^* = \text{Hom}_{\mathbb{R}}(\tau, \mathbb{C})$$

be the complexified dual tangent bundle of  $M$ . Then the (complex) tensor product  $\tau_{\mathbb{C}}^* \otimes \zeta$  is also a complex vector bundle over  $M$ . The vector space of smooth sections of this bundle will be denoted by  $C^\infty(\tau_{\mathbb{C}}^* \otimes \zeta)$ .

DEFINITION. A *connection* on  $\zeta$  is a  $\mathbb{C}$ -linear mapping

$$\nabla : C^\infty(\zeta) \rightarrow C^\infty(\tau_{\mathbb{C}}^* \otimes \zeta)$$

which satisfies the Leibniz formula

$$\nabla(fs) = df \otimes s + f\nabla(s)$$

for every  $s \in C^\infty(\zeta)$  and every  $f \in C^\infty(M, \mathbb{C})$ . The image  $\nabla(s)$  is called the *covariant derivative* of  $s$ .

The basic properties of connections can be outlined as follows. First note that *the correspondence*  $s \mapsto \nabla(s)$  *decreases supports*. That is, if

the section  $s$  vanishes throughout an open subset  $U \subset M$  then  $\nabla(s)$  vanishes throughout  $U$  also. For given  $x \in U$  we can choose a smooth function  $f$  which vanishes outside  $U$  and is identically 1 near  $x$ . The identity

$$df \otimes s + f\nabla(s) = \nabla(fs) = 0,$$

evaluated at  $x$ , shows that  $\nabla(s)$  vanishes at  $x$ .

REMARK. A linear mapping  $L: C^\infty(\zeta) \rightarrow C^\infty(\eta)$  which decreases supports is also called a *local operator*, since the value of  $L(s)$  at  $x$  depends only on the values of  $s$  at points in an arbitrarily small neighborhood of  $x$ . (A theorem of [Peetre] asserts that every local operator is a *differential operator*, that is it can be expressed locally as a finite linear combination of partial derivatives, with coefficients in  $C^\infty(\eta)$ .)

Since a connection  $\nabla$  is a local operator, it makes sense to talk about the restriction of  $\nabla$  to an open subset of  $M$ . If a collection of open sets  $U_\alpha$  covers  $M$ , then a global connection is uniquely determined by its restrictions to the various  $U_\alpha$ .

If the open set  $U$  is small enough so that  $\zeta|U$  is trivial, then the collection of all possible connections on  $\zeta|U$  can be described as follows. Choose a basis  $s_1, \dots, s_n$  for the sections of  $\zeta|U$ , so that every section can be written uniquely as a sum  $f_1 s_1 + \dots + f_n s_n$ , where the  $f_i$  are smooth complex valued functions.

LEMMA 1. A connection  $\nabla$  on the trivial bundle  $\zeta|U$  is uniquely determined by  $\nabla(s_1), \dots, \nabla(s_n)$ , which can be completely arbitrary smooth sections of the bundle  $\tau_C^* \otimes \zeta|U$ . Each of the sections  $\nabla(s_i)$  can be written uniquely as a sum  $\sum \omega_{ij} \otimes s_j$  where  $[\omega_{ij}]$  can be an arbitrary  $n \times n$  matrix of  $C^\infty$  complex 1-forms on  $U$ .

We adopt the convention that  $\sum$  always stands for the summation over all indices which appear twice.

In fact, given  $\nabla(s_1), \dots, \nabla(s_n)$  we can define  $\nabla$  for an arbitrary section by the formula

$$\nabla(f_1 s_1 + \dots + f_n s_n) = \sum (df_i \otimes s_i + f_i \nabla(s_i)) .$$

Details will be left to the reader. ■

As an example, there is one and only one connection such that the covariant derivatives  $\nabla(s_1), \dots, \nabla(s_n)$  are all zero; or in other words so that the connection matrix  $[\omega_{ij}]$  is zero. It is given by  $\nabla\left(\sum f_i s_i\right) = \sum df_i \otimes s_i$ . This particular "flat" connection depends of course on the choice of basis  $\{s_i\}$ .

The collection of all connections on  $\zeta$  does not have any natural vector space structure. Note however that if  $\nabla_1$  and  $\nabla_2$  are two connections on  $\zeta$ , and  $g$  is a smooth complex valued function on  $M$ , then the linear combination  $g\nabla_1 + (1-g)\nabla_2$  is again a well defined connection on  $\zeta$ .

**LEMMA 2.** *Every smooth complex vector bundle with paracompact base space possesses a connection.*

*Proof.* Choose open sets  $U_\alpha$  covering the base space with  $\zeta|U_\alpha$  trivial, and choose a smooth partition of unity  $\{\lambda_\alpha\}$  with  $\text{supp}(\lambda_\alpha) \subset U_\alpha$ . Each restriction  $\zeta|U_\alpha$  possesses a connection  $\nabla_\alpha$  by Lemma 1. The linear combination  $\sum \lambda_\alpha \nabla_\alpha$  is now a well defined global connection. ■

Next let us consider the case of an induced vector bundle. Given a smooth map  $g: M' \rightarrow M$  we can form the induced vector bundle  $\zeta' = g^* \zeta$ . Note that there is a canonical  $C^\infty(M, \mathbb{C})$ -linear mapping

$$g^* : C^\infty(\zeta) \rightarrow C^\infty(\zeta') .$$

Also, any 1-form on  $M$  pulls back to a 1-form on  $M'$ , so there is a canonical  $C^\infty(M, \mathbb{C})$ -linear mapping

$$g^* : C^\infty(\tau_C^*(M) \otimes \zeta) \rightarrow C^\infty(\tau_C^*(M') \otimes \zeta') .$$

LEMMA 3. To each connection  $\nabla$  on  $\zeta$  there corresponds one and only one connection  $\nabla' = g^*\nabla$  on the induced bundle  $\zeta'$  so that the following diagram is commutative

$$\begin{array}{ccc} C^\infty(\zeta) & \xrightarrow{\nabla} & C^\infty(\tau_C^*(M) \otimes \zeta) \\ \downarrow & & \downarrow \\ C^\infty(\zeta') & \xrightarrow{\nabla'} & C^\infty(\tau_C^*(M') \otimes \zeta') . \end{array}$$

For example, given sections  $s_1, \dots, s_n$  over an open subset  $U$  of  $M$  with  $\nabla(s_i) = \sum \omega_{ij} \otimes s_j$  we can form the lifted 1-forms  $\omega'_{ij}$  and the lifted sections  $s'_i$  over  $g^{-1}(U)$ . If such a connection  $\nabla'$  exists, then evidently

$$\nabla'(s'_i) = \sum \omega'_{ij} \otimes s'_j .$$

Further details will be left to the reader. ■

Given a connection  $\nabla$  on  $\zeta$ , let us try to construct something like a connection on the bundle  $\tau_C^* \otimes \zeta$ . We will make use of  $\nabla$  together with the exterior differentiation operator  $d : C^\infty(\tau_C^*) \rightarrow C^\infty(\Lambda^2 \tau_C^*)$ .

LEMMA 4. Given  $\nabla$  there is one and only one  $C$ -linear mapping

$$\widehat{\nabla} : C^\infty(\tau_C^* \otimes \zeta) \rightarrow C^\infty(\Lambda^2 \tau_C^* \otimes \zeta)$$

which satisfies the Leibniz formula

$$\widehat{\nabla}(\theta \otimes s) = d\theta \otimes s - \theta \wedge \nabla(s)$$

for every 1-form  $\theta$  and every section  $s \in C^\infty(\zeta)$ . Furthermore  $\widehat{\nabla}$  satisfies the identity  $\widehat{\nabla}(f(\theta \otimes s)) = df \wedge (\theta \otimes s) + f\widehat{\nabla}(\theta \otimes s)$ .

*Proof.* In terms of a local basis  $s_1, \dots, s_n$  for the sections, we must have

$$\widehat{\nabla}(\theta_1 \otimes s_1 + \dots + \theta_n \otimes s_n) = \sum (d\theta_i \otimes s_i - \theta_i \wedge \nabla(s_i)) .$$

Taking this formula as definition of  $\widehat{\nabla}$ , the required identities are easily verified. ■

Now let us consider the composition  $K = \widehat{\nabla} \circ \nabla$  of the two  $\mathbb{C}$ -linear mappings

$$\mathcal{C}^\infty(\zeta) \xrightarrow{\nabla} \mathcal{C}^\infty(\tau_C^* \otimes \zeta) \xrightarrow{\widehat{\nabla}} \mathcal{C}^\infty(\Lambda^2 \tau_C^* \otimes \zeta) .$$

LEMMA 5. *The value of the section  $K(s) = \widehat{\nabla}(\nabla(s))$  at  $x$  depends only on  $s(x)$ , not on the values of  $s$  at other points of  $M$ . Hence the correspondence*

$$s(x) \mapsto K(s)(x)$$

*defines a smooth section of the complex vector bundle*

$$\text{Hom}(\zeta, \Lambda^2 \tau_C^* \otimes \zeta).$$

DEFINITION. This section  $K = K_\nabla$  of the vector bundle  $\text{Hom}(\zeta, \Lambda^2 \tau_C^* \otimes \zeta) \cong \Lambda^2 \tau_C^* \otimes \text{Hom}(\zeta, \zeta)$  is called the *curvature tensor* of the connection  $\nabla$ .

*Proof of Lemma 5.* Clearly  $K$  is a local operator. The computation  $\widehat{\nabla}(\nabla(fs)) = \widehat{\nabla}(df \otimes s + f \nabla(s)) = 0 - df \wedge \nabla(s) + df \wedge \nabla(s) + f \widehat{\nabla}(\nabla(s))$  shows that the composition  $\widehat{\nabla} \circ \nabla = K$  is actually  $\mathcal{C}^\infty(M, \mathbb{C})$ -linear:

$$K(fs) = fK(s) .$$

Now if  $s(x) = s'(x)$  then, in terms of a local basis  $s_1, \dots, s_n$  for sections we have

$$s' - s = f_1 s_1 + \dots + f_n s_n$$

near  $x$ , where  $f_1(x) = \dots = f_n(x) = 0$ . Hence



$$K(s') - K(s) = \sum f_i K(s_i)$$

vanishes at  $x$ . This completes the proof. ■

In terms of a basis  $s_1, \dots, s_n$  for the sections of  $\zeta|U$ , with  $\nabla(s_i) = \sum \omega_{ij} \otimes s_j$ , note the explicit formula

$$\begin{aligned} K(s_i) &= \hat{\nabla} \left( \sum \omega_{ij} \otimes s_j \right) \\ &= \sum \Omega_{ij} \otimes s_j \end{aligned}$$

where we have set

$$\Omega_{ij} = d\omega_{ij} - \sum \omega_{i\alpha} \wedge \omega_{\alpha j} .$$

Thus  $K$  can be described locally by the  $n \times n$  matrix  $\Omega = [\Omega_{ij}]$  of 2-forms in much the same way that  $\nabla$  is described locally by the matrix  $\omega = [\omega_{ij}]$  of 1-forms. In matrix notation, we have

$$\Omega = d\omega - \omega \wedge \omega .$$

A fundamental theorem, which we will not prove, asserts that the curvature tensor  $K$  is zero if and only if, in the neighborhood of each point of  $M$  there exists a basis  $s_1, \dots, s_n$  for the sections of  $\zeta$  so that  $\nabla(s_1) = \dots = \nabla(s_n) = 0$ . (Compare [Bishop-Crittenden] or [Kobayashi-Nomizu].) In fact if  $M$  is simply connected and  $K = 0$ , then there exist global sections  $s_1, \dots, s_n$  with  $\nabla(s_1) = \dots = \nabla(s_n) = 0$ . It follows in that case of course that  $\zeta$  is a trivial bundle. If the tensor  $K = K_{\nabla}$  is zero, then the connection  $\nabla$  is called *flat*.

REMARK. Using Steenrod's terminology, a bundle with flat connection can be described as a bundle with *discrete structural group*. To see this consider two different local bases, say  $s_1, \dots, s_n \in C^\infty(\zeta|U)$  and  $s'_1, \dots, s'_n \in C^\infty(\zeta|V)$ , both of which have covariant derivatives zero. Over the intersection  $U \cap V$  we can set  $s'_i = \sum a_{ij} s_j$ . The equation

$\nabla(s'_i) = \sum da_{ij} \otimes s_j = 0$  shows that the transition functions  $a_{ij}$  are locally constant. Hence the associated mapping

$$[a_{ij}] : U \cap V \rightarrow GL(n, \mathbb{C})$$

is continuous, even if the linear group  $GL(n, \mathbb{C})$  is provided with the discrete topology.

Starting with the curvature tensor  $K$ , we can construct characteristic classes as follows. Let  $M_n(\mathbb{C})$  be the algebra consisting of all  $n \times n$  complex matrices.

**DEFINITION.** An *invariant polynomial* on  $M_n(\mathbb{C})$  is a function

$$P : M_n(\mathbb{C}) \rightarrow \mathbb{C}$$

which can be expressed as a complex polynomial in the entries of the matrix, and satisfies

$$P(XY) = P(YX) ,$$

or equivalently

$$P(TXT^{-1}) = P(X)$$

for every non-singular matrix  $T$ .

(The first identity evidently follows from the second when  $Y$  is non-singular, and the general case follows by continuity, since every singular matrix can be approximated by non-singular matrices.)

*Examples.* The trace function  $[X_{ij}] \mapsto \sum X_{ii}$ , and the determinant function are well known examples of invariant polynomials on  $M_n(\mathbb{C})$ .

If  $P$  is an invariant polynomial, then an exterior form  $P(K)$  on the base space  $M$  is defined as follows. Choosing a local basis  $s_1, \dots, s_n$  for the sections near  $x$ , we have  $K(s_i) = \sum \Omega_{ij} \otimes s_j$ . The matrix  $\Omega = [\Omega_{ij}]$  has entries in the commutative algebra over  $\mathbb{C}$  consisting of all exterior forms of even degree. It makes perfect sense therefore to evaluate

the complex polynomial  $P$  at  $\Omega$ , thus obtaining an algebra element. The resulting algebra element  $P(\Omega)$  does not depend on the choice of basis  $s_1, \dots, s_n$ , since a change of basis will replace the matrix  $\Omega$  by one of the form  $T\Omega T^{-1}$  where  $T$  is a non-singular matrix of functions. Since  $P(T\Omega T^{-1}) = P(\Omega)$ , these various local differential forms  $P(\Omega)$  are uniquely defined. They piece together to yield a global differential form which we denote by  $P(K)$ .

REMARK 1. If  $P$  is a homogeneous polynomial of degree  $r$ , then of course  $P(K)$  is an exterior form of degree  $2r$ . In general,  $P$  will be a sum of homogeneous polynomials of various degrees, and correspondingly  $P(K)$  will be a sum of exterior forms of various even degrees. We will use the notation  $P(K) \in C^\infty(\Lambda^{2r}_C^*) = \bigoplus C^\infty(\Lambda^r_C^*)$ .

REMARK 2. More generally, in place of an invariant polynomial, one can equally well use an invariant formal power series of the form

$$P = P_0 + P_1 + P_2 + \dots$$

where each  $P_r$  is an invariant homogeneous polynomial of degree  $r$ . Then  $P(K)$  is still well defined, since  $P_r(K) = 0$  for  $2r > \dim(M)$ . (A notable example of an invariant formal power series is the Chern character  $\text{ch}(A) = \text{trace}(e^{A/2\pi i})$ .)

FUNDAMENTAL LEMMA. *For any invariant polynomial (or invariant formal power series)  $P$ , the exterior form  $P(K)$  is closed, that is  $dP(K) = 0$ .*

*Proof.* Given any invariant polynomial or formal power series  $P(A) = P([A_{ij}])$ , where the  $A_{ij}$  stand for indeterminates, we can form the matrix

$$[\partial P / \partial A_{ij}]$$

of formal first derivatives. It will be convenient to denote the *transpose* of this matrix by the symbol  $P'(A)$ .

Now let  $\Omega = [\Omega_{ij}]$  be the curvature matrix with respect to some basis for  $\zeta|U$ . Evidently the exterior derivative  $dP(\Omega)$  is equal to the expression

$$\sum (\partial P / \partial \Omega_{ij}) d\Omega_{ij} .$$

In matrix notation, we can write this as

$$(1) \quad dP(\Omega) = \text{trace}(P'(\Omega) d\Omega) .$$

The matrix  $d\Omega$  of 3-forms can be computed by taking the exterior derivative of the matrix equation

$$\Omega = d\omega - \omega \wedge \omega ,$$

and then substituting this equation back into the result. This yields the *Bianchi identity*

$$(2) \quad d\Omega = \omega \wedge \Omega - \Omega \wedge \omega .$$

We will need the following remark. *For any invariant polynomial or power series  $P$ , the transposed matrix of first derivatives  $P'(A)$  commutes with  $A$ .* To prove this statement, let  $E_{ji}$  denote the matrix with entry 1 in the  $(j,i)$ -th place and zeros elsewhere. Differentiating the equation

$$P((I + tE_{ji})A) = P(A(I + tE_{ji}))$$

with respect to  $t$  and then setting  $t = 0$ , we obtain

$$\sum A_{i\alpha} (\partial P / \partial A_{j\alpha}) = \sum (\partial P / \partial A_{ai}) A_{aj} .$$

Thus the matrix  $A$  commutes with the transpose of  $[\partial P / \partial A_{ij}]$ , as asserted.

Substituting  $\Omega$  for the matrix of indeterminates  $A$ , it follows that

$$(3) \quad \Omega \wedge P'(\Omega) = P'(\Omega) \wedge \Omega .$$

It will be convenient to use the notation  $X$  for the product matrix  $P'(\Omega) \wedge \omega$ . Now substituting the Bianchi identity (2) into (1) and using (3) we obtain

$$\begin{aligned} dP(\Omega) &= \text{trace}(X \wedge \Omega - \Omega \wedge X) \\ &= \sum (X_{ij} \wedge \Omega_{ji} - \Omega_{ji} \wedge X_{ij}) . \end{aligned}$$

Since each  $X_{ij}$  commutes with the 2-form  $\Omega_{ji}$ , this sum is zero, which proves the Fundamental Lemma. ■

Thus the exterior form  $P(K)$  is closed, or in other words is a de Rham cocycle, representing an element which we denote by  $(P(K))$  in the total de Rham cohomology ring  $H^{\oplus}(M; \mathbb{C}) = \bigoplus H^i(M; \mathbb{C})$ .

**COROLLARY.** *The cohomology class  $(P(K)) = (P(K_{\nabla}))$  is independent of the connection  $\nabla$ .*

*Proof.* Let  $\nabla_0$  and  $\nabla_1$  be two different connections on  $\zeta$ . Mapping  $M \times \mathbb{R}$  to  $M$  by the projection  $(x, t) \mapsto x$ , we can form the induced bundle  $\zeta'$  over  $M \times \mathbb{R}$ , the induced connections  $\nabla'_0$  and  $\nabla'_1$ , and the linear combination

$$\nabla = t\nabla'_1 + (1-t)\nabla'_0 .$$

Thus  $P(K_{\nabla})$  is a de Rham cocycle on  $M \times \mathbb{R}$ .

Now consider the map  $i_{\varepsilon}: x \mapsto (x, \varepsilon)$  from  $M$  to  $M \times \mathbb{R}$ , where  $\varepsilon$  equals 0 or 1. Evidently the induced connection  $(i_{\varepsilon})^*\nabla$  on  $(i_{\varepsilon})^*\zeta'$  can be identified with the connection  $\nabla_{\varepsilon}$  on  $\zeta$ . Therefore

$$(i_{\varepsilon})^*(P(K_{\nabla})) = (P(K_{\nabla_{\varepsilon}})) .$$

But the mapping  $i_0$  is homotopic to  $i_1$  hence the cohomology class  $(P(K_{\nabla_0}))$  is equal to  $(P(K_{\nabla_1}))$ . ■

Thus  $P$  determines a *characteristic cohomology class* in  $H^*(M; \mathbb{C})$  depending only on the isomorphism class of the vector bundle  $\zeta$ . If a map  $g: M' \rightarrow M$  induces a bundle  $\zeta' = g^*\zeta$ , with induced connection  $\nabla'$ , then clearly

$$P(K_{\nabla'}) = g^* P(K_{\nabla}) .$$

Thus these characteristic classes are well behaved with respect to induced bundles.

But we already know from Section 14 that any characteristic class for complex vector bundles can be expressed as a polynomial in the Chern classes. Thus we are left with the following two questions: What invariant polynomials exist; and how can their associated characteristic classes be expressed explicitly in terms of Chern classes?

The first question can easily be answered as follows. For any square matrix  $A$ , let  $\sigma_k(A)$  denote the  $k$ -th elementary symmetric function of the eigenvalues of  $A$ , so that

$$\det(I+tA) = 1 + t\sigma_1(A) + \dots + t^n\sigma_n(A) .$$

LEMMA 6. Any invariant polynomial on  $M_n(\mathbb{C})$  can be expressed as a polynomial function of  $\sigma_1, \dots, \sigma_n$ .

*Proof.* Given  $A \in M_n(\mathbb{C})$  we can choose  $B$  so that  $BAB^{-1}$  is an upper triangular matrix; in fact, we could actually put  $A$  in Jordan canonical form. Replacing  $B$  by  $\text{diag}(\varepsilon, \varepsilon^2, \dots, \varepsilon^n)B$ , we can then make the off diagonal entries arbitrarily close to zero. By continuity it follows that  $P(A)$  depends only on the diagonal entries of  $BAB^{-1}$ , or in other words on the eigenvalues of  $A$ . Since  $P(A)$  must certainly be a symmetric function of these eigenvalues, the classical theory of symmetric functions completes the proof. ■

We will see later that the characteristic class  $(\sigma_r(K))$  is equal to a complex multiple of the Chern class  $c_r(\zeta)$ .

Leaving this for the moment, let us look at the corresponding theory for real vector bundles. The concepts of a connection

$$\nabla : C^\infty(\xi) \rightarrow C^\infty(\tau^* \otimes \xi)$$

on a real vector bundle  $\xi$ , and of its curvature tensor

$$K \in C^\infty(\text{Hom}(\xi, \Lambda^2 \tau^* \otimes \xi)) \cong C^\infty(\Lambda^2 \tau^* \otimes \text{Hom}(\xi, \xi)) ,$$

are defined just as above, simply substituting the real numbers for the complex numbers throughout. Any invariant polynomial  $P$  on the matrix algebra  $M_n(\mathbb{R})$  gives rise to a characteristic cohomology class  $(P(K)) \in H^*(M; \mathbb{R})$ .

The most classical and familiar example of a connection is provided by the Levi-Civita connection on the tangent or dual tangent bundle of a Riemannian manifold. We will next give an outline of this theory.

First consider a real vector bundle  $\xi$  over  $M$  which is provided with a Euclidean metric. Thus if  $s$  and  $s'$  are smooth sections of  $\xi$ , then the inner product  $\langle s, s' \rangle$  is a smooth real valued function on  $M$ .

DEFINITION. A connection  $\nabla$  on  $\xi$  is *compatible* with the metric if the identity

$$d\langle s, s' \rangle = \langle \nabla s, s' \rangle + \langle s, \nabla s' \rangle$$

is valid for all sections  $s$  and  $s'$ .

Here it is understood that the inner products on the right are defined by the requirement that

$$\langle \theta \otimes s, s' \rangle = \langle s, \theta \otimes s' \rangle = \langle s, s' \rangle \theta$$

for all  $\theta \in C^\infty(\tau^*)$  and all  $s, s' \in C^\infty(\xi)$ . Unfortunately this notation can be confusing in some situations. It is safer in general to make use of the following.

LEMMA 7. Let  $s_1, \dots, s_n$  be an orthonormal basis for the sections of  $\xi|U$ , so that  $\langle s_i, s_j \rangle = \delta_{ij}$ . Then a connection  $\nabla$  on  $\xi|U$  is compatible with the metric if and only if the associated connection matrix  $[\omega_{ij}]$  (defined by  $\nabla(s_i) = \sum \omega_{ij} \otimes s_j$ ) is skew-symmetric.

For if  $\nabla$  is compatible, then

$$\begin{aligned} 0 &= d\langle s_i, s_j \rangle = \langle \nabla s_i, s_j \rangle + \langle s_i, \nabla s_j \rangle \\ &= \left\langle \sum \omega_{ik} \otimes s_k, s_j \right\rangle + \left\langle s_i, \sum \omega_{jk} \otimes s_k \right\rangle = \omega_{ij} + \omega_{ji} . \end{aligned}$$

The converse will be left to the reader. ■

REMARK. The appearance of skew-symmetric matrices at this point is of course bound up with the fact that the Lie algebra of the orthogonal group  $O(n)$  is equal to the sub-Lie algebra of  $M_n(\mathbb{R})$  consisting of all skew-symmetric matrices.

Now let us specialize to the case where the bundle  $\xi$  is equal to the dual tangent bundle  $\tau^*$  of  $M$ .

DEFINITION. A connection  $\nabla$  on  $\tau^*$  is *symmetric* (or *torsion free*) if the composition

$$C^\infty(\tau^*) \xrightarrow{\nabla} C^\infty(\tau^* \otimes \tau^*) \xrightarrow{\wedge} C^\infty(\Lambda^2 \tau^*)$$

is equal to the exterior derivative  $d$ .

In terms of local coordinates  $x^1, \dots, x^n$ , setting

$$\nabla(dx^k) = \sum \Gamma_{ij}^k dx^i \otimes dx^j$$

this requires that the image  $\sum \Gamma_{ij}^k dx^i \wedge dx^j$  must be equal to the exterior derivative  $d(dx^k) = 0$ . Hence the "Christoffel symbols"  $\Gamma_{ij}^k$  must be symmetric in  $i, j$ . More generally, the following is easily verified.

ASSERTION. A connection  $\nabla$  on  $\tau^*$  is symmetric if and only if the second covariant derivative

$$\nabla(df) \in C^\infty(\tau^* \otimes \tau^*)$$

of an arbitrary smooth function  $f$  is a symmetric tensor. That is, in terms of a local basis  $\theta_1, \dots, \theta_n$  for the sections of  $\tau^*$ , one must have  $\nabla d(f) = \sum a_{ij} \theta_i \otimes \theta_j$  with  $a_{ij} = a_{ji}$ .



LEMMA 8. *The dual tangent bundle  $\tau^*$  of a Riemannian manifold possesses one and only one symmetric connection which is compatible with its metric.*

This preferred connection  $\nabla$  is called the *Riemannian connection* or the *Levi-Civita connection*.

*Proof.* Let  $\theta_1, \dots, \theta_n$  be an orthonormal basis for the sections of  $\tau^*|U$ . We will show that there is one and only one skew-symmetric matrix  $[\omega_{kj}]$  of 1-forms such that

$$d\theta_k = \sum \omega_{kj} \wedge \theta_j .$$

Defining a connection  $\nabla$  over  $U$  by the requirement that

$$\nabla(\theta_k) = \sum \omega_{kj} \otimes \theta_j$$

it evidently follows that  $\nabla$  is the unique symmetric connection for  $\tau^*|U$  which is compatible with the metric. Since these local connections are unique, they agree on intersections  $U \cap U'$  and so piece together to yield the required global connection.

We will need the following combinatorial remark. Any  $n \times n \times n$  array of real valued functions  $A_{ijk}$  can be written uniquely as the sum of an array  $B_{ijk}$  which is symmetric in  $i, j$  and an array  $C_{ijk}$  which is skew-symmetric in  $j, k$ . In fact, existence can be proved by inspecting the explicit formulas

$$B_{ijk} = \frac{1}{2} (A_{ijk} + A_{jik} - A_{kij} - A_{kji} + A_{jki} + A_{ikj})$$

$$C_{ijk} = \frac{1}{2} (A_{ijk} - A_{jik} + A_{kij} + A_{kji} - A_{jki} - A_{ikj}) ;$$

and uniqueness is clear since if an array  $D_{ijk}$  were both symmetric in  $i, j$  and skew in  $j, k$  then the equalities

$$D_{123} = D_{213} = -D_{231} = -D_{321} = D_{312} = D_{132} = -D_{123}$$

would show that the typical entry  $D_{123}$  is zero.

Now choosing functions  $A_{ijk}$  so that  $d\theta_k = \sum A_{ijk}\theta_i \wedge \theta_j$  and setting  $A_{ijk} = B_{ijk} + C_{ijk}$  as above, it follows that  $d\theta_k = \sum C_{ijk}\theta_i \wedge \theta_j$ . In fact, the 1-forms

$$\omega_{kj} = \sum C_{ijk}\theta_i$$

evidently constitute the unique skew-symmetric matrix with  $d\theta_k = \sum \omega_{kj} \wedge \theta_j$ . This proves Lemma 8. ■

Let us specialize to the case of a 2-dimensional oriented Riemannian manifold. With respect to an oriented local orthonormal basis  $\theta_1, \theta_2$  for 1-forms, the connection and curvature matrices take the form

$$\begin{bmatrix} 0 & \omega_{12} \\ -\omega_{12} & 0 \end{bmatrix} \text{ and } \begin{bmatrix} 0 & \Omega_{12} \\ -\Omega_{12} & 0 \end{bmatrix},$$

with  $d\omega_{12} = \Omega_{12}$ . *The identity*

$$\begin{bmatrix} \cos t & \sin t \\ -\sin t & \cos t \end{bmatrix} \begin{bmatrix} 0 & \Omega_{12} \\ -\Omega_{12} & 0 \end{bmatrix} \begin{bmatrix} \cos t & -\sin t \\ \sin t & \cos t \end{bmatrix} = \begin{bmatrix} 0 & \Omega_{12} \\ -\Omega_{12} & 0 \end{bmatrix}$$

shows that the exterior 2-form  $\Omega_{12}$  is independent of the choice of oriented orthonormal basis. Hence it gives rise to a well defined global 2-form.

DEFINITION. This form  $\Omega_{12}$  is called the *Gauss-Bonnet* 2-form on the oriented surface. Denoting the oriented area 2-form  $-\theta_1 \wedge \theta_2$  briefly by the symbol  $dA$ , we can set  $\Omega_{12} = KdA$  where  $K$  is a scalar function called the *Gaussian curvature*.

Since both  $\Omega_{12}$  and  $dA$  change sign if we reverse the orientation of  $M$ , it follows that  $K$  is independent of orientation.

*Note on signs.* The above choice of sign for  $dA$  may look strange to the reader. It can be justified as follows. In conformity with [MacLane], and as described in Appendix A, we introduce a sign of  $(-1)^{mn}$  whenever an object of dimension  $m$  is permuted with an adjacent object of dimension  $n$ . Thus if  $I^n$  denotes the unit cube with ordered coordinates  $t_1, \dots, t_n$  and canonical orientation class  $\mu \in H_n(I^n, \partial I^n)$ , we set

$$\begin{aligned} \langle dt_1 \wedge \dots \wedge dt_n, \mu \rangle &= \left\langle dt_1 \wedge \dots \wedge dt_n, \int_{t_1=0}^1 \dots \int_{t_n=0}^1 \right\rangle \\ &= (-1)^{n+(n-1)+\dots+1} \int_{t_1=0}^1 dt_1 \dots \int_{t_n=0}^1 dt_n = (-1)^{n(n+1)/2}. \end{aligned}$$

In other words the "oriented volume  $n$ -form" on  $I^n$  is, by definition, set equal to  $(-1)^{n(n+1)/2} dt_1 \wedge \dots \wedge dt_n$ . This choice of signs leads to a version of Stokes' theorem,

$$\langle d\phi, \mu \rangle + (-1)^{\dim \phi} \langle \phi, \partial\mu \rangle = 0,$$

which is compatible with Appendix A. Readers who prefer to use the classical sign conventions as in [Spanier], [Warner], and [Bott-Chern] can forget about these signs, but should replace  $K$  by  $-K$  wherever it occurs in our characteristic class formulas.

To give some reality to this rather abstract definition, let us carry out a more explicit computation. In some neighborhood  $U$  of an arbitrary point on a Riemannian 2-manifold, one can introduce *geodesic coordinates*  $x, y$  so that the metric quadratic differential in  $C^\infty(\tau^* \otimes \tau^* | U)$  takes the form  $dx \otimes dx + g(x, y)^2 dy \otimes dy$ . Then setting

$$\theta_1 = dx, \quad \theta_2 = g dy$$

we obtain an orthonormal basis for the 1-forms over  $U$ . The equations

$$d\theta_1 = \omega_{12} \wedge \theta_2$$

$$d\theta_2 = -\omega_{12} \wedge \theta_1$$

have unique solution  $\omega_{12} = g_x dy$ , where subscript  $x$  stands for the partial derivative. It follows that

$$\Omega_{12} = g_{xx} dx \wedge dy = (-g_{xx}/g) dA .$$

Thus the Gaussian curvature is given by

$$K = -g_{xx}/g .$$

As an example, taking latitude and longitude as coordinates on the unit sphere, we have  $g(x, y) = \cos(x)$ , and therefore  $K = 1$ .

**GAUSS-BONNET THEOREM.** *For any closed oriented Riemannian 2-manifold, the integral  $\iint \Omega_{12} = \iint K dA$  is equal to  $2\pi e[M]$ .*

*Proof.* More generally, consider any oriented 2-plane bundle  $\xi$  with Euclidean metric. Then  $\xi$  has a canonical complex structure  $J$  which rotates each vector through an angle of  $\pi/2$  in the "counter-clockwise" direction. In terms of an oriented local orthonormal basis  $s_1, s_2$  for sections, we have  $J s_1(x) = s_2(x)$ . Choosing any compatible connection on  $\xi$ , we have

$$\nabla s_1 = \omega_{12} \otimes s_2$$

$$\nabla s_2 = -\omega_{12} \otimes s_1 .$$

Evidently  $\nabla$  gives rise to a connection on the resulting complex line bundle  $\zeta$ , where

$$\nabla s_1 = \omega_{12} \otimes i s_1 = i \omega_{12} \otimes s_1$$

and consequently  $\nabla(i s_1) = i \nabla(s_1) = -\omega_{12} \otimes s_1$ . Thus the connection matrix of this complex connection is the  $1 \times 1$  matrix  $[i \omega_{12}]$  and the

curvature matrix is  $[i\Omega_{12}]$ . Applying the invariant polynomial  $\sigma_1 = \text{trace}$ , we obtain a closed 2-form

$$\text{trace}[i\Omega_{12}] = i\Omega_{12}$$

which represents some characteristic cohomology class in  $H^2(M; \mathbb{C})$ . But the only characteristic class in  $H^2(\quad; \mathbb{C})$  for complex line bundles  $\zeta$  is the Chern class  $c_1(\zeta) = e(\zeta_{\mathbb{R}})$  (and its multiples). Therefore

$$(i\Omega_{12}) = \alpha c_1(\zeta) = \alpha e(\xi)$$

for some complex constant  $\alpha$ .

To evaluate this constant  $\alpha$ , it is only necessary to calculate both sides explicitly for one particular case. Suppose for example that  $\xi$  is the dual tangent bundle  $\tau^*$  of a closed oriented 2-dimensional Riemannian manifold  $M$ . Since  $(i\Omega_{12}) = \alpha e(\tau^*)$ , it follows that

$$\iint i\Omega_{12} = \alpha e[M]$$

or in other words

$$i \iint \mathcal{K} dA = \alpha e[M] .$$

Evaluating both sides for the unit 2-sphere, we see that  $\alpha = 2\pi i$ . This completes the proof. ■

**THEOREM.** *Let  $\zeta$  be a complex vector bundle with connection  $\nabla$ . Then the cohomology class  $(\sigma_1(\mathcal{K}_{\nabla}))$  is equal to  $(2\pi i)^r c_1(\zeta)$ .*

*Proof.* In the case of a complex line bundle, the argument above shows that

$$(\sigma_1(\mathcal{K})) = \alpha c_1(\zeta) = 2\pi i c_1(\zeta) .$$

Define the invariant polynomial  $\underline{c}$  by

$$\begin{aligned} \underline{c}(A) &= \det(\mathbb{I} + A/2\pi i) \\ &= \sum \sigma_k(A)/(2\pi i)^k . \end{aligned}$$

Thus, for a complex line bundle the cocycle

$$\underline{c}(K) = 1 + \sigma_1(K)/(2\pi i)$$

represents the cohomology class  $c(\zeta) = 1 + c_1(\zeta)$ . Now consider any bundle  $\zeta$  which splits as a Whitney sum  $\zeta_1 \oplus \dots \oplus \zeta_n$  of line bundles. Choosing connections  $\nabla_1, \dots, \nabla_n$  on the  $\zeta_j$ , there is evidently a "Whitney sum" connection on  $\zeta$ . Choosing a local section  $s_j$  for  $\zeta_j$  near  $x$ , we can consider  $s_1, \dots, s_n$  as sections of  $\zeta$ . The corresponding local curvature matrix is diagonal:

$$\Omega = \text{diag}(\Omega_1, \dots, \Omega_n) ,$$

and hence

$$\underline{c}(\Omega) = \underline{c}(\Omega_1) \dots \underline{c}(\Omega_n) .$$

It follows that the corresponding global exterior forms have the same property

$$\underline{c}(K) = \underline{c}(K_1) \dots \underline{c}(K_n) .$$

But the right side of this equation represents the total Chern class

$$c(\zeta_1) \dots c(\zeta_n) = c(\zeta) .$$

Thus the equality  $c(\zeta) = (\underline{c}(K))$  is true for any bundle  $\zeta$  which is a Whitney sum of line bundles.

The general case now follows by a standard argument. (Compare [Hirzebruch, Section 4.2], or the uniqueness proof for Stiefel-Whitney classes in Section 7.) If  $\gamma^1$  denotes the universal line bundle over  $P_m(\mathbb{C})$  with  $m$  large, then the  $n$ -fold cross product of copies of  $\gamma^1$  satisfies

$$c(\gamma^1 \times \dots \times \gamma^1) = (\underline{c}(K(\gamma^1 \times \dots \times \gamma^1))) .$$

Since the cohomology of the base space  $G_n(\mathbb{C}^\infty)$  of the universal bundle  $\gamma^n$  maps monomorphically into the cohomology of  $P_m(\mathbb{C}) \times \dots \times P_m(\mathbb{C})$  in dimensions  $\leq 2m$ , it follows that

$$c(y^n) = (\underline{c}(K(y^n))) .$$

Therefore  $c(\zeta) = (\underline{c}(K(\zeta)))$  for an arbitrary bundle  $\zeta$ . ■

**COROLLARY 1.** *For any real vector bundle  $\xi$  the de Rham cocycle  $\sigma_{2k}(K)$  represents the cohomology class  $(2\pi)^{2k} p_k(\xi)$  in  $H^{4k}(M; \mathbb{R})$ , while  $\sigma_{2k+1}(K)$  is a coboundary.*

In other words the total Pontrjagin class  $1 + p_1(\xi) + p_2(\xi) + \dots$  in  $H^\oplus(M; \mathbb{R})$  corresponds to the invariant polynomial  $\underline{p}(A) = \det(I + A/2\pi)$ . This follows immediately from the Theorem together with the definition of Pontrjagin classes. ■

**REMARK.** Here is a direct proof that  $\sigma_{2k+1}(K)$  is a coboundary. Choose a Euclidean metric on  $\xi$ , and choose a compatible connection  $\nabla$ . Then the connection matrix with respect to a local orthonormal basis for sections is skew symmetric, and it follows easily that the associated curvature matrix  $\Omega$  is skew also,  $\Omega^t = -\Omega$ . Therefore

$$\sigma_m(\Omega) = \sigma_m(\Omega^t) = (-1)^m \sigma_m(\Omega) .$$

Thus  $\sigma_m(K_{\nabla})$  is zero as a cocycle for  $m$  odd. For an arbitrary (non-metric) connection  $\nabla'$ , it follows that  $\sigma_m(K_{\nabla'})$  is a coboundary.

**COROLLARY 2.** *If a real [or complex] vector bundle possesses a flat connection, then all of its Pontrjagin [or Chern] classes with rational coefficients are zero.*

The proof is clear. ■

**REMARK.** If the homology  $H_*(M; \mathbb{Z})$  with integer coefficients is finitely generated, then it also follows that the Pontrjagin [or Chern] classes with integer coefficients are torsion elements. These torsion

elements are not zero in general. [Bott and Heitsch] have recently constructed a real [or complex] vector bundle with discrete structural group whose Pontrjagin [or Chern] classes in  $H^*(B; \mathbb{Z})$  are non-torsion elements which satisfy no polynomial relations. Of course the homology  $H_*(B; \mathbb{Z})$  cannot be finitely generated.

One piece of information is conspicuously absent in the above discussion. We do not have any expression for the Euler class of an oriented  $2n$ -plane bundle in terms of curvature (except for a very special construction in the case  $n = 1$ ). This is not just an accident. We will see later by an example that there cannot be any formula for the Euler class in terms of the curvature of an arbitrary connection. The situation changes, however, if the connection is required to be compatible with a Euclidean metric on  $\xi$ .

The following classical construction will be needed.

LEMMA 9. *There exists one and up to sign only one polynomial with integer coefficients which assigns, to each  $2n \times 2n$  skew-symmetric matrix  $A$  over a commutative ring, a ring element  $\text{Pf}(A)$  whose square is the determinant of  $A$ . Furthermore*

$$\text{Pf}(BAB^t) = \text{Pf}(A) \det(B)$$

for any  $2n \times 2n$  matrix  $B$ .

We will specify the sign by requiring that  $\text{Pf}(\text{diag}(S, \dots, S)) = +1$ , where  $S$  denotes the  $2 \times 2$  matrix  $\begin{bmatrix} 0 & 1 \\ -1 & 0 \end{bmatrix}$ . The resulting polynomial  $\text{Pf}$  is called the *Pfaffian*. As examples,

$$\text{Pf} \begin{bmatrix} 0 & a \\ -a & 0 \end{bmatrix} = a,$$

and the Pfaffian of a  $4 \times 4$  skew matrix  $[a_{ij}]$  equals  $a_{12}a_{34} - a_{13}a_{24} + a_{14}a_{23}$ .



To prove<sup>1</sup> Lemma 9, we will work in the ring  $\Lambda = \mathbb{Z}[A_{12}, \dots, A_{2n-12n}, B_{11}, \dots, B_{2n2n}]$  in which all of the above diagonal entries of the skew matrix  $A = [A_{ij}]$  and all of the entries of  $B = [B_{ij}]$  are distinct indeterminates. Over the quotient field of  $\Lambda$ , it is not difficult to find a matrix  $X$  so that  $XAX^t = \text{diag}(S, \dots, S)$ . Hence the polynomial  $\det(A) \in \Lambda$  is equal to a square  $\det(X)^{-2}$  in the quotient field of  $\Lambda$ . Since  $\Lambda$  is a unique factorization domain, this implies that  $\det(A)$  is a square already within  $\Lambda$ .

Similarly, the identity  $\det(BAB^t) = \det(A)\det(B)^2$  implies that

$$\text{Pf}(BAB^t) = \pm \text{Pf}(A)\det(B),$$

and specializing to  $B = I$  we see that the sign must be  $+1$ . ■

Now let  $\xi$  be an oriented  $2n$ -plane bundle with Euclidean metric. Choosing an oriented orthonormal basis for the sections of  $\xi$  throughout a coordinate neighborhood  $U$ , the curvature matrix  $\Omega = [\Omega_{ij}]$  is skew symmetric, so

$$\text{Pf}(\Omega) \in C^\infty(\Lambda^{2n}_r^* | U)$$

is defined. Choosing a different oriented orthonormal basis for the sections over  $U$ , this exterior form will be replaced by  $\text{Pf}(X\Omega X^{-1})$  where the matrix  $X$  is orthogonal ( $X^{-1} = X^t$ ) and orientation preserving ( $\det X = 1$ ). Hence the Pfaffian is unchanged. Thus we can piece these local forms together to obtain a global  $2n$ -form

$$\text{Pf}(K) \in C^\infty(\Lambda^{2n}_r^*) .$$

(As an example, for  $n = 2$  we recover the statement that the Gauss-Bonnet 2-form  $\Omega_{12} = \text{Pf}(K)$  is globally well defined.) Just as in the previous case, one can verify that the matrix of formal partial derivatives  $[\partial \text{Pf}(A) / \partial A_{ij}]$  commutes with  $A$ , and hence that

<sup>1</sup> For details, see [Bourbaki, *Algebre*, Chapter 9, p. 82].

$$d\text{Pf}(K) = 0 .$$

Thus  $\text{Pf}(K)$  represents a characteristic cohomology class in  $H^{2n}(M; \mathbb{R})$ . Passing to a bundle  $\tilde{\gamma}$  which is universal in dimensions  $\leq 4n$ , since the square of  $\text{Pf}(K(\tilde{\gamma}))$  represents the cohomology class

$$(\det(K(\tilde{\gamma}))) = (2\pi)^{2n} p_n(\tilde{\gamma}) ,$$

we see that

$$(\text{Pf}(K(\tilde{\gamma}))) = \pm (2\pi)^n e(\tilde{\gamma})$$

and hence that  $(\text{Pf}(K(\xi))) = \pm (2\pi)^n e(\xi)$  for any oriented  $2n$ -plane bundle  $\xi$ . In fact, the sign is  $+1$ , as can be verified by evaluating both sides for a Whitney sum of  $2$ -plane bundles. Thus we have proved the following.

**GENERALIZED GAUSS-BONNET THEOREM.** *For any oriented  $2n$ -plane bundle  $\xi$  with Euclidean metric and any compatible connection, the exterior  $2n$ -form  $\text{Pf}(K/2\pi)$  represents the Euler class  $e(\xi)$ .*

**REMARK.** This theorem helps to illustrate the general Chern-Weil result that for any compact Lie group  $G$  with Lie algebra  $\mathfrak{g}$ , the cohomology  $H^\oplus(B_G; \mathbb{R})$  of the classifying space is isomorphic to the algebra consisting of all polynomial functions  $\mathfrak{g} \rightarrow \mathbb{R}$  which are invariant under the adjoint action of  $G$ . This general assertion fails for non-compact groups such as  $SL(2n, \mathbb{R})$ .

As an example, suppose that  $\tau^*$  is the dual tangent bundle of the unit sphere  $S^{2n}$ , with the Levi-Civita connection. Choosing an oriented, orthonormal basis  $\theta_1, \dots, \theta_n$  for the sections of  $\tau^*|_U$ , computation shows that

$$-\Omega_{ij} = \theta_i \wedge \theta_j .$$

(This equation expresses the fact that the “sectional curvature” of the unit sphere is identically equal to  $+1$ .) Furthermore

$$(-1)^n \text{Pf}(\Omega) = \text{Pf}[\theta_1 \wedge \theta_2] = (1 \cdot 3 \cdot 5 \cdot 7 \cdot \dots \cdot (2n-1)) \theta_1 \wedge \dots \wedge \theta_{2n} .$$

Integrating over  $S^{2n}$ , this yields

$$\int \text{Pf}(K) = (1 \cdot 3 \cdot 5 \cdot \dots \cdot (2n-1)) \text{volume}(S^{2n}) .$$

Setting this expression equal to  $(2\pi)^n e[S^{2n}] = 2(2\pi)^n$ , we obtain a novel proof for the identity:  $\text{volume}(S^{2n}) = 2(2\pi)^n / 1 \cdot 3 \cdot 5 \cdot \dots \cdot (2n-1)$ .

To conclude this appendix, we will show that the Euler class cannot be determined by the curvature tensor of an arbitrary (non-metric) connection. *In fact we will describe an example of an oriented vector bundle with flat connection such that the Euler class with real coefficients is non-zero.* (Compare [Milnor, 1958] and [Wood].) Suppose that we are given a homomorphism from the fundamental group  $\Pi = \pi_1(M)$  to the special linear group  $SL(n, \mathbb{R})$ . Then  $\Pi$  acts on the universal covering  $\tilde{M}$  and hence acts diagonally on the product  $\tilde{M} \times \mathbb{R}^n$ . It is not hard to see that the natural mapping

$$(\tilde{M} \times \mathbb{R}^n) / \Pi \rightarrow \tilde{M} / \Pi \cong M$$

is the projection map of an  $n$ -plane bundle  $\xi$  with flat connection (or equivalently, with discrete structural group). We will devise such an example with  $e(\xi) \neq 0$ .

Let  $M$  be a compact Riemann surface of genus  $g > 1$ . Then the universal covering  $\tilde{M}$  is conformally diffeomorphic to the complex upper half plane  $H$ . (See for example [Springer].) Every element in the group  $\Pi$  of covering transformations corresponds to a fractional linear transformation of  $H$  of the form

$$z \mapsto (az + b)/(cz + d) ,$$

where the matrix

$$\begin{bmatrix} a & b \\ c & d \end{bmatrix} \in SL(2, \mathbb{R})$$

is well defined up to sign. Thus we have constructed a homomorphism  $h$  from  $\Pi$  to the quotient group

$$\text{PSL}(2, \mathbb{R}) = \text{SL}(2, \mathbb{R}) / \{\pm I\} .$$

We will show that  $h$  lifts to a homomorphism  $\Pi \rightarrow \text{SL}(2, \mathbb{R})$  which induces the required 2-plane bundle over  $M$ .

The group  $\text{PSL}(2, \mathbb{R})$  operates naturally on the real projective line  $\mathbb{P}^1(\mathbb{R})$ , which can be identified with the boundary  $\mathbb{R} \cup \infty$  of  $H$ . Hence  $h$  induces a bundle  $\eta$  over  $M$  with fiber  $\mathbb{P}^1(\mathbb{R})$  and projection map

$$(\tilde{M} \times \mathbb{P}^1(\mathbb{R})) / \Pi \rightarrow \tilde{M} / \Pi = M .$$

We will think of  $\eta$  as a bundle whose structural group is the group  $\text{PSL}(2, \mathbb{R})$  with the discrete topology. *This induced bundle  $\eta$  can be identified with the tangent circle bundle of  $M$ .* In fact, any non-zero tangent vector  $v$  at a point  $z$  of  $H$  is tangent to a unique oriented circle segment (or vertical line segment) which leads from  $z$  to a point  $f(z, v)$  on the boundary  $\mathbb{R} \cup \infty$ , and which crosses this boundary orthogonally. (See Figure 8.) The mapping  $f$  is invariant under the action of  $\Pi$  (that is,  $f(\sigma z, D\sigma_z(v)) = \sigma f(z, v)$  for  $\sigma \in \Pi$ ), and therefore induces the required isomorphism from the bundle of tangent directions on  $M$  to the  $(\mathbb{R} \cup \infty)$ -bundle  $\eta$ . (Notation as on p. 8.) *It follows that the Euler number  $e(\eta)[M]$  is equal to  $2 - 2g \neq 0$ .*

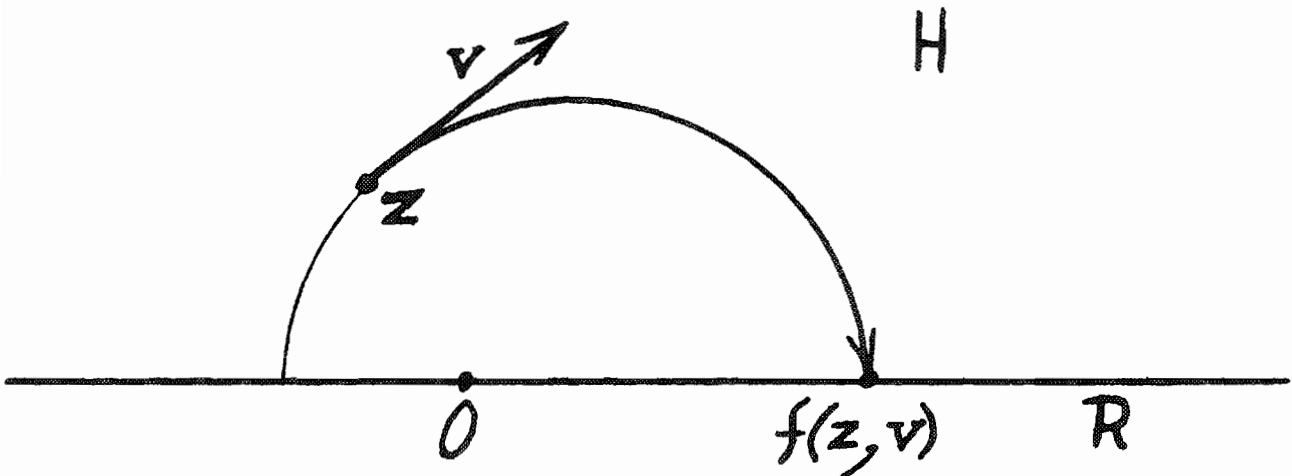

Fig. 8.

Let  $E_0$  be the total space of  $\eta$ , and  $E$  the total space of the associated topological 2-disk bundle. Since  $e(\eta)$  is divisible by 2, it follows that  $w_2(\eta) = 0$ . Hence, from the exact sequence of the pair  $(E, E_0)$  it follows that the fundamental class  $u \in H^2(E, E_0; \mathbb{Z}/2)$  lifts back to a cohomology class  $a \in H^1(E_0; \mathbb{Z}/2)$  whose restriction to each fiber is non-zero. Let  $\hat{E}_0 \rightarrow E_0$  be the 2-fold covering space associated with this cohomology class  $a$ . Then the composition  $\hat{E}_0 \rightarrow E_0 \rightarrow M$  constitutes a new circle bundle  $\hat{\eta}$  over  $M$ . Using for example the obstruction definition, we see that  $e(\hat{\eta}) = \frac{1}{2}e(\eta)$ . Thus the Euler number of  $\hat{\eta}$  is  $1 - g \neq 0$ .

The structural group of this new bundle  $\hat{\eta}$  is evidently the 2-fold covering group  $SL(2, \mathbb{R})$  of  $PSL(2, \mathbb{R})$ , acting on the 2-fold covering of  $P_1(\mathbb{R})$ . (This is clear since  $PSL(2, \mathbb{R})$  actually has the same homotopy type as the space  $P_1(\mathbb{R})$  upon which it acts.) But  $\eta$  has discrete structural group, so  $\hat{\eta}$  does also. Hence  $\hat{\eta}$  is induced by a suitable homomorphism  $\Pi \rightarrow SL(2, \mathbb{R})$ . The associated 2-plane bundle evidently has a flat connection, and has Euler number  $1 - g \neq 0$ . ■

## Bibliography

- Adams, J. F., *On the non-existence of elements of Hopf invariant one*, Annals of Math. 72 (1960), 20-104.
- , *Vector fields on spheres*, Annals of Math. 75 (1962), 602-632.
- , *On the groups  $J(X)$ , II and IV*, Topology 3 (1965), 137-171, and 5 (1966), 21-71.
- , "S. P. Novikov's work on operations on complex cobordism," Lecture Notes, Univ. of Chicago, 1967.
- , "Quillen's work on formal groups and complex cobordism," Lecture Notes, Univ. of Chicago, 1970.
- , "Algebraic Topology: a student's guide," Cambridge Univ. Press, 1972.
- Adem, J., *The iteration of the Steenrod squares in algebraic topology*, Proc. Nat. Acad. Sci. U.S.A. 38 (1952), 720-726.
- Alexandroff, P., and Hopf, H., "Topologie," Springer-Verlag, 1933.
- American Math. Soc., Proceedings Symposia in Pure Math. 27, Differential Geometry, to appear.
- Anderson, D. W., *The real K-theory of classifying spaces*, Proc. Nat. Acad. Sci. U.S.A. 51 (1964), 634-636.
- , Brown, E., and Peterson, F. P., *The structure of the Spin cobordism ring*, Annals of Math. 86 (1967), 271-298.
- Artin, E., "The Gamma Function," Holt, Rinehart and Winston, 1964. (Translated from Hamburg Math. Einzelschr. 1 (1931).)
- Atiyah, M., "K-theory," Benjamin, New York, 1967.
- and Hirzebruch, F., *Vector bundles and homogeneous spaces*, Proc. Symp. Pure Math. III, Amer. Math. Soc. (1961), 7-38.
- and Singer, I., *The index of elliptic operators*, III, Annals of Math. 87 (1968), 546-604.
- Baum, P., *Chern classes and singularities of complex foliations*, Proc. Symp. Pure Math. 27, Differential Geometry, Amer. Math. Soc., to appear.

- Bishop, R. L., and Crittenden, R. J., "Geometry of Manifolds," Academic Press, 1964.
- Blanton, J. D., and Schweitzer, P. A., *Axioms for characteristic classes of manifolds*, Proc. Symp. Pure Math. 27, Differential Geometry, Amer. Math. Soc., to appear.
- Boardman, M., and Vogt, R., *Homotopy everything H-spaces*, Bull. Amer. Math. Soc. 74 (1968), 1117-1122.
- \_\_\_\_\_, "Homotopy Invariant Algebraic Structures on Topological Spaces," Lecture Notes in Math. 347, Springer-Verlag, 1973.
- Borel, A., *Le plan projectif des octaves et les sphères comme espaces homogènes*, C. R. Acad. Sci. Paris 230 (1950), 1378-1380.
- \_\_\_\_\_, *La cohomologie mod 2 de certains espaces homogènes*, Comm. Math. Helv. 27 (1953), 165-197.
- \_\_\_\_\_, *Sur la cohomologie des espaces fibrés principaux et des espaces homogènes de groupes de Lie compacts*, Annals of Math. 57 (1953), 115-207.
- \_\_\_\_\_, *Topology of Lie groups and characteristic classes*, Bull. Amer. Math. Soc. 61 (1955), 397-432.
- \_\_\_\_\_, "Seminar on Transformation Groups," Annals of Math. Studies 46, Princeton Univ. Press, 1960.
- Borevich, Z. I., and Shafarevich, I. R., "Number Theory," Academic Press, 1966 (translated from the Russian).
- Bott, R., *The space of loops on a Lie group*, Mich. Math. J. 5 (1958), 35-61.
- \_\_\_\_\_, *The stable homotopy of the classical groups*, Annals of Math. 70 (1959), 313-337.
- \_\_\_\_\_, *A note on the KO-theory of sphere bundles*, Bull. Amer. Math. Soc. 68 (1962), 395-400.
- \_\_\_\_\_, *The periodicity theorem for the classical groups and some of its applications*, Advances in Math. 4 (1970), 353-411.
- \_\_\_\_\_, *On a topological obstruction to integrability*, Proc. Symp. Pure Math. 16, Amer. Math. Soc. 1970, 127-132.
- \_\_\_\_\_, *The Lefschetz formula and exotic characteristic classes*, Symposia Math. 10, Differential Geometry, Rome, 1972.
- \_\_\_\_\_, and Chern, S. S., *Hermitian vector bundles and the equidistribution of the zeroes of their holomorphic sections*, Acta Math. 114 (1965), 71-112.
- \_\_\_\_\_, and Haefliger, A., *On characteristic classes of  $\Gamma$  foliations*, Bull. Amer. Math. Soc. 78 (1972), 1039-1044.

- and Heitsch, J., *A remark on the integral cohomology of  $B\Gamma_q$* , *Topology* 11 (1972), 141-146.
- and Milnor, J., *On the parallelizability of spheres*, *Bull. Amer. Math. Soc.* 64 (1958), 87-89.
- Bourbaki, N., “*Éléments de Math., Algèbre*,” Hermann, Paris, 1942-.... .
- Boy, W., *Über die Curvatura integra und die Topologie geschlossener Flächen*, *Math. Ann.* 57 (1903), 151-184.
- Brody, E. J., *Topological classification of lens spaces*, *Annals of Math.* 71 (1960), 163-184.
- Browder, W., and Hirsch, M., *Surgery on piecewise linear manifolds and applications*, *Bull. Amer. Math. Soc.* 72 (1966), 959-964.
- Brown, A. B., *Functional dependence*, *Trans. Amer. Math. Soc.* 38 (1935), 379-394.
- Brumfiel, G., Madsen, I., and Milgram, R. J., *PL-characteristic classes and cobordism*, *Bull. Amer. Math. Soc.* 77 (1971), 1025-1030 (detailed version: *Annals of Math.* 97 (1973), 82-159).
- Cartan, H., and Eilenberg, S., “*Homological Algebra*,” Princeton Univ. Press, 1956.
- Cerf, J., “*Sur les difféomorphismes de la sphère de dimension trois ( $I_4 = 0$ )*,” *Lecture Notes in Math.* 53, Springer-Verlag, 1968.
- Chapman, T. A., *Compact Hilbert cube manifolds and the invariance of Whitehead torsion*, *Bull. Amer. Math. Soc.* 79 (1973), 52-56.
- Chern, S. S., *On the multiplication in the characteristic ring of a sphere bundle*, *Annals of Math.* 49 (1948), 362-372.
- , *Geometry of characteristic classes*, to appear.
- and Simons, J., *Some cohomology classes in principal fiber bundles and their application in Riemannian geometry*, *Proc. Nat. Acad. Sci., U.S.A.* 68 (1971), 791-794.
- , *Characteristic forms and geometric invariants*, *Annals of Math.* 99 (1974), 48-69.
- Chevalley, C., “*Theory of Lie Groups*,” Princeton Univ. Press, 1946.
- Conner, P., and Floyd, E., “*The relation of cobordism to K-theories*,” *Lecture Notes in Math.* 28, Springer-Verlag, 1966.
- Dold, A., *Partitions of unity in the theory of fibrations*, *Annals of Math.* 78 (1963), 223-255.
- , “*Lectures on Algebraic Topology*,” Springer-Verlag, 1972.
- Dugundji, J., “*Topology*,” Allyn and Bacon, Boston, 1966.
- Dyer, E., “*Cohomology Theories*,” Benjamin, New York, 1969.



- Ehresmann, C., *Sur la topologie de certains espaces homogènes*, *Annals of Math.* 35 (1934), 396-443.
- , *Sur la topologie de certaines variétés algébriques réelles*, *J. Math. Pures Appl.* (9) 16 (1937), 69-100.
- , *Introduction à la théorie des structures infinitésimales et des pseudo-groupes de Lie*, *Colloque de topologie et géométrie différentielle*, Strasbourg, 1952, No. 11, La Bibliothèque Nationale et Universitaire de Strasbourg, 1953.
- Eilenberg, S., and Steenrod, N., "Foundations of Algebraic Topology," Princeton Univ. Press, 1952.
- Godbillon, C., and Vey, J., *Un invariant des feuilletages de codimension 1*, *C. R. Acad. Paris* 273 (1971), 92-95.
- Graves, L., "Theory of functions of real variables" (2<sup>nd</sup> ed.), McGraw-Hill, N. Y., 1956.
- Gunning, R. C., and Rossi, H., "Analytic functions of several complex variables," Prentice Hall, Englewood Cliffs, N. J., 1965.
- Haefliger, A., and Wall, C. T. C., *Pieccwise linear bundles in the stable range*, *Topology* 4 (1965), 109-214.
- Halperin, S., and Toledo, D., *Stiefel-Whitney homology classes*, *Annals of Math.* 96 (1972), 511-525.
- Hardy, G. H., and Wright, E. M., "An Introduction to the Theory of Numbers," 3<sup>rd</sup> ed., Clarendon Press, Oxford, 1956.
- Hilbert, D., and Cohn-Vossen, S., "Geometry and the Imagination," Chelsea, N. Y., 1956.
- Hilton, P. J., and Wylie, S., "Homology Theory: An Introduction to Algebraic Topology," Cambridge Univ. Press, 1960.
- Hirsch, M., *Immersion of manifolds*, *Trans. Amer. Math. Soc.* 93 (1959), 242-276.
- , *Obstruction theories for smoothing manifolds and maps*, *Bull. Amer. Math. Soc.* 69 (1963), 352-356.
- Hirzebruch, F., *On Steenrod's reduced powers, the index of inertia and the Todd genus*, *Proc. Nat. Acad. Sci. U.S.A.* 39 (1953), 951-956.
- , *Über die quaternionalen projektiven Räume*, *S. -Ber. math. -naturw. Kl. Bayer. Akad. Wiss. München* (1953), 301-312.
- , "Topological Methods in Algebraic Geometry," 3<sup>rd</sup> ed., Springer-Verlag, 1966.
- Hörmander, L., "An Introduction to Complex Analysis in Several Variables," Van Nostrand, 1966.
- Hurewicz, W., *On the concept of fibre space*, *Proc. Nat. Acad. Sci. U.S.A.* 41 (1955), 956-961.

- Husemoller, D., "Fibre Bundles," McGraw-Hill, 1966.
- James, I. M., *Euclidean models of projective spaces*, Bull. London Math. Soc. 3 (1971), 257-276.
- \_\_\_\_\_ and Whitehead, J. H. C., *The homotopy theory of sphere bundles over spheres: I*, Proc. London Math. Soc. 4 (1954), 196-218.
- Kahn, P. J., *A note on topological Pontrjagin classes and the Hirzebruch index formula*, Illinois J. Math. 16 (1972), 243-256.
- Kaplansky, I., "Infinite Abelian Groups," Univ. Michigan Press, 1954.
- Karoubi, M., *Cobordisme et groupes formels (d'après D. Quillen et T. tom Dieck)*, Séminaire Bourbaki 1971/72, 408, Lecture Notes in Math. 317, Springer-Verlag, 1973.
- Kelley, J. L., "General Topology," Van Nostrand, New York, 1955.
- Kervaire, M., *Non-parallelizability of the  $n$ -sphere for  $n > 7$* , Proc. Nat. Acad. Sci., U.S.A. 44 (1958), 280-283.
- \_\_\_\_\_ and Milnor, J. W., *Groups of homotopy spheres: I*, Annals of Math. 77 (1963), 504-537.
- Kirby, R., and Siebenmann, L., *On the triangulation of manifolds and the Hauptvermutung*, Bull. Amer. Math. Soc. 75 (1969), 742-749.
- Kister, J., *Microbundles are fibre bundles*, Annals of Math. 80 (1964), 190-199.
- Kneser, H., *Analytische Struktur und Abzählbarkeit*, Ann. Acad. Sci. Fenn. Ser. A. I., 251/5 (1958).
- Kobayashi, S., and Nomizu, K., "Foundations of differential geometry: I," Interscience, New York, 1963.
- Lang, S., "Algebra," Addison-Wesley, 1965.
- Lashof, R. K., and Rothenberg, M., *Microbundles and smoothing*, Topology 3 (1965), 357-388.
- Lundell, A. T., and Weingram, S., "The Topology of CW Complexes," Van Nostrand Reinhold, 1969.
- MacLane, S., "Homology," (Grundlehren 114), Springer-Verlag, 1963.
- \_\_\_\_\_ and Birkhoff, G., "Algebra," MacMillan 1967.
- Macmahon, P. A., "Combinatory Analysis," Cambridge Univ. Press, 1915-16.
- Mahowald, M., *The order of the image of the  $J$ -homomorphism*, Bull. Amer. Math. Soc. 76 (1970), 1310-1313.
- May, J. P., "Geometry of iterated loop spaces," Lecture Notes in Math. 271, Springer-Verlag, 1972.

- Milgram, R. J., *The mod 2 spherical characteristic classes*, Annals of Math. 92 (1970), 238-261.
- Milnor, J. W., *On manifolds homeomorphic to the 7-sphere*, Annals of Math. 64 (1956), 399-405.
- , *On the existence of a connection with curvature zero*, Comm. Math. Helv., 32 (1958), 215-223.
- , *Microbundles: I*, Topology 3 (Suppl. 1) (1964), 53-80.
- , "Topology from the Differentiable Viewpoint," Univ. Press Va., Charlottesville, 1965.
- , *On characteristic classes for spherical fibre spaces*, Comm. Math. Helv. 43 (1968), 51-77.
- and Kervaire, M. A., *Bernoulli numbers, homotopy groups, and a theorem of Rohlin*, Proc. Int. Cong. Math., Edinburgh 1958, Cambridge Univ. Press 1960.
- Miyazaki, H., *Paracompactness of CW complexes*, Tohoku Math. J. 4 (1952), 309-313.
- Munkres, J. R., "Elementary Differential Topology," Annals of Math. Studies 54, Princeton Univ. Press, revised ed. 1966.
- , *Obstructions to imposing differentiable structures*, Illinois J. Math. 8 (1964), 361-376, and 12 (1968), 610-615.
- Newlander, A., and Nirenberg, L., *Complex analytic coordinates in almost complex manifolds*, Annals of Math. 65 (1957), 391-404.
- Nielsen, N., "Traité élémentaire des nombres de Bernoulli," Gauthier-Villars, Paris, 1923.
- Nomizu, K., "Lie Groups and Differential Geometry," Math. Soc. of Japan, 1956.
- Novikov, S. P., *Homotopically equivalent smooth manifolds*, Izv. Akad. Nauk SSSR Ser. Mat. 28 (1964), 365-474.
- , *On manifolds with free abelian fundamental group and their applications*, Izv. Akad. Nauk SSSR 30 (1966), 207-246.
- , *Algebraic topological methods from the point of view of cobordism theory*, Izv. Akad. Nauk SSSR 31 (1967), 855-951 [Math. USSR-Izv. 1 (1967), 827-913.].
- Ostmann, H., "Additive Zahlentheorie," Springer-Verlag, 1956.
- Peetre, J., *Une caractérisation abstraite des opérateurs différentiels*, Math. Scand. 7 (1959), 211-218 and 8 (1960), 116-120.
- Peterson, F. P., *Some results on cohomotopy groups*, Amer. J. Math. 78 (1956), 243-258.

- \_\_\_\_\_, *Some results on PL-cobordism*, J. Math. Kyoto U. 9 (1969), 189-194.
- \_\_\_\_\_, *The mod p homotopy type of BSO and F/PL*, Bol. Soc. Mat. Mex. 14 (1969), 22-27.
- \_\_\_\_\_, *Twisted cohomology operations and exotic characteristic classes*, Advances in Math. 4 (1970), 81-90.
- \_\_\_\_\_ and Toda H., *On the structure of  $H^*(BSF; \mathbb{Z}_p)$* , J. Math. Kyoto U. 7 (1967), 113-121.
- Pontrjagin, L. S., *Characteristic cycles on differentiable manifolds*, Mat. Sbornik N. S. 21(63) (1947), 233-284; A.M.S. Translation 32 (1950).
- Quillen, D., *The Adams conjecture*, Topology 10 (1971), 67-80.
- \_\_\_\_\_, *Elementary proofs of some results of cobordism theory using Steenrod operations*, Advances in Math. 7 (1971), 29-56.
- Ravenel, D., *A definition of exotic characteristic classes of spherical fibrations*, Comm. Math. Helv. 47 (1972), 421-436.
- de Rham, G., "Variétés Différentiables," Hermann, Paris, 1955.
- Rohlin, V. A., *A three-dimensional manifold is the boundary of a four-dimensional one*, Dokl. Akad. Nauk SSSR 81 (1951), 355-357.
- \_\_\_\_\_ and Svarč, A. S., *The combinatorial invariance of Pontrjagin classes*, Dokl. Akad. Nauk SSSR (N.S.) 114 (1957), 490-493.
- Rourke, C. P., and Sanderson, B. J., "Introduction to Piecewise-linear Topology," Ergebnisse 69, Springer-Verlag, 1972.
- Sard, A., *The measure of the critical values of differentiable maps*, Bull. Amer. Math. Soc. 48 (1942), 883-890.
- Schubert, H., "Kalkül der abzählenden Geometrie," Teubner, Leipzig, 1879.
- Segal, G., *Categories and cohomology theories*, to appear.
- Serre, J. -P., *Groupes d'homotopie et classes des groupes abéliens*, Annals of Math. 58 (1953), 258-294.
- Shih, W., *Une remarque sur les classes de Thom*, C. R. Acad. Sci. Paris, 260 (1965), 6259-6262.
- \_\_\_\_\_ and Singh Varma, H. O., *Sur les KO-classes caractéristiques des fibrés réels*, C. R. Acad. Sci. Paris 273-A (1971), 1212-1214.
- Shimada, N., *Differentiable structures on the 15-sphere and Pontrjagin classes of certain manifolds*, Nagoya Math. J. 12 (1957), 56-69.
- Smale, S., *The classification of immersions of spheres in Euclidean space*, Annals of Math. 69 (1959), 327-344.
- \_\_\_\_\_, *Differentiable and combinatorial structures on manifolds*, Annals of Math. 74 (1961), 498-502.

- Spanier, E. H., "Algebraic Topology," McGraw-Hill, 1966.
- and Whitehead, J. H. C., *Duality in homotopy theory*,  
Mathematika 2 (1955), 56-80.
- Spivak, M., *Spaces satisfying Poincare duality*, Topology 6 (1967), 77-101.
- Springer, G., "Introduction to Riemann Surfaces," Addison-Wesley, 1957.
- Stasheff, J. D., *A classification theorem for fibre spaces*, Topology 2  
(1963), 239-246.
- , *More characteristic classes for spherical fiber spaces*, Comm.  
Math. Helv. 49 (1968), 78-86.
- Steenrod, N., "Topology of Fibre Bundles," Princeton Univ. Press,  
Princeton, N. J., 1951.
- and Epstein, D., "Cohomology Operations," Annals of Math.  
Studies 50, Princeton Univ. Press, 1962.
- and Whitehead, J. H. C., *Vector fields on the n-sphere*, Proc.  
Nat. Acad. Sci., U.S.A., 37 (1951), 58-63.
- Sternberg, S., "Lectures on Differential Geometry," Prentice-Hall,  
Englewood Cliffs, N. J., 1964.
- Stiefel, E., *Richtungsfelder und Fernparallelismus in Mannigfaltigkeiten*.  
Comm. Math. Helv. 8 (1936), 3-51.
- Stong, R. E., "Notes on Cobordism Theory," Princeton Math. Notes,  
Princeton Univ. Press, 1958.
- Sullivan, D., *Geometric Topology: I*, MIT (mimeographed), 1970.
- Swan, R., *Vector bundles and projective modules*, Trans. Amer. Math. Soc.  
105 (1962), 264-277.
- Szczarba, R., *On tangent bundles of fibre spaces and quotient spaces*,  
Amer. J. Math. 86 (1964), 685-697.
- Tamura, I., *On Pontrjagin classes and homotopy type of manifolds*, J. Math.  
Soc. Japan 9 (1957), 250-262.
- Thom, R., *Espaces fibrés en spheres et carrés de Steenrod*, Annals Sci.  
Ecole Norm. Sup. 69 (1952), 109-181.
- , *Quelques propriétés globales des variétés différentiables*,  
Comm. Math. Helv. 28 (1954), 17-86.
- , *Les singularités des applications différentiables*, Ann. Inst.  
Fourier, Grenoble 6 (1955-56), 43-87.
- , *Les classes caractéristiques de Pontrjagin des variétés  
triangulées*, Symposium Internacional de Topologia Algebraica,  
Mexico, La Universidad Nacional Autonoma de México y la Unesco,  
1958.
- Thomas, E., *On tensor products of n-plane bundles*, Archiv der Math. 10  
(1959), 174-179.

- \_\_\_\_\_, *On the cohomology of the real Grassmann complexes and the characteristic classes of  $n$ -plane bundles*, Trans. Amer. Math. Soc., 96 (1960), 67-89.
- \_\_\_\_\_, *On the cohomology groups of the classifying space for the stable spinor group*, Bol. Soc. Mat. Mex (1962), 57-69.
- \_\_\_\_\_, *The torsion Pontrjagin classes*, Proc. Amer. Math. Soc. 13 (1962), 485-488.
- Thurston, W., *Non-cobordant foliations of  $S^3$* , Bull. Amer. Math. Soc. 78 (1972), 511-514.
- van der Waerden, B. L., "Einführung in die Algebraische Geometrie," Springer-Verlag, Berlin, 1939.
- \_\_\_\_\_, "Modern Algebra," Ungar, New York, 1949.
- Wall, C. T. C., *Determination of the cobordism ring*, Annals of Math. 72 (1960), 292-311.
- Warner, F., "Foundations of Differentiable Manifolds and Lie Groups," Scott, Foresman and Co., Glenview, Illinois, 1971.
- Whitehead, G. W., *Generalized homology theories*, Trans. Amer. Math. Soc. 102 (1962), 227-284.
- Whitehead, J. H. C., *On  $C^1$ -complexes*, Annals of Math. 41 (1940), 809-824.
- \_\_\_\_\_, *Combinatorial homotopy I*, Bull. Amer. Math. Soc. 55 (1949), 213-245.
- \_\_\_\_\_, *Manifolds with transverse fields in Euclidean space*, Annals of Math. 73 (1961), 154-212.
- Whitney, H., *Sphere spaces*, Proc. Nat. Acad. Sci. 21 (1935), 462-468.
- \_\_\_\_\_, *On the theory of sphere bundles*, Proc. Nat. Acad. Sci. U.S.A. 26 (1940), 148-153.
- \_\_\_\_\_, *On the topology of differentiable manifolds*, Lectures in Topology, Univ. of Michigan Press, 1941, 101-141.
- \_\_\_\_\_, *The self-intersections of a smooth  $n$ -manifold in  $2n$ -space*, Annals of Math. 45 (1944), 220-246.
- \_\_\_\_\_, *The singularities of a smooth  $n$ -manifold in  $(2n-1)$ -space*, Annals of Math. 45 (1944), 247-293.
- \_\_\_\_\_, "Geometric Integration Theory," Princeton Univ. Press, 1957.
- Williamson, R. W., *Cobordism of combinatorial manifolds*, Annals of Math. 83 (1966), 1-33.
- Wood, J., *Bundles with totally disconnected structural group*, Comm. Math. Helv. 46 (1971), 257-273.

Wu W. -T., *On the product of sphere bundles and the duality theorem modulo two*, *Annals of Math.* 49 (1948), 641-653.

—————, *On Pontrjagin classes: II*, *Scientia Sinica* 4 (1955), 455-490.

—————, "A theory of embedding, immersion, and isotopy of polytopes in a Euclidean space," *Science Press, Peking*, 1965.

## Index

- Adams, J. F., 134, 286  
Alexander duality, 280  
Alexandroff line, 23  
algebraic hypersurface, 196  
almost complex structure, 151  
associated bundle, 139, 195  
  
BF, 252  
BO(n), BSO(n), 145, 179, 250ff  
    (see Grassmann manifold)  
BU(n), 163  
base space, 13, 27  
basis, 10, 23, 95f, 128  
Bernoulli numbers  $B_n$ , 225, 230, 281ff  
Bianchi identity, 297  
bilinear, 21, 31, 48  
binomial coefficients, 45f, 94, 184f  
Bockstein homomorphism, 182, 253  
bordant, bordism group, 255  
Borel, A., 134, 189  
Bott periodicity, 244, 255  
boundary, 53, 78, 186, 199, 224  
boundary homomorphism, 112, 258, 262  
bundle homotopy, 65  
bundle map, 26, 37, 42, 61, 65, 98  
bundle of finite type, 71  
  
 $\mathcal{C}$ -isomorphism, 207, 233  
CW-complex, 73-81, 139-148, 165, 171, 260ff, 268ff  
canonical line bundle  $\gamma^1$ , 16, 43, 71, 93  
canonical  $n$ -plane bundle  $\gamma^n$ , 59-71, 141f  
    oriented  $\tilde{\gamma}^n$ , 145  
    complex, 152, 159-163, 227f  
cap product, 113, 135, 233, 276ff  
Cartan formula, 91  
Cartesian product, 3, 27, 34, 54, 64, 92, 100  
category, 8, 32, 34  
Cauchy-Riemann equations, 150, 153  
Cayley numbers, 48, 134  
cell, cell structure – see CW-complex  
chain complex, mapping, 111ff, 182  
characteristic class, 37, 68f, 250f, 298  
characteristic map, 73  
Chern, S.-S., v  
Chern character, 195f, 296  
Chern class  $c_i$ , 38, 155ff, 174-177, 182, 189ff, 220, 243, 299, 306  
Chern number, 183ff, 191ff  
Chern product theorem, 164  
Chern-Weil theorem, 311  
Christoffel symbol, 301  
classifying space, 163, 250ff, 255  
    – see Grassmann manifold and  $B(\ )$   
closure finiteness, 74  
cobordism, 53f, 197-203, 211ff, 223, 253, 256  
coboundary, 258  
cohomology, 89, 257-280  
    generalized, 254  
    with compact support, 275



- of BF, 252f
- of BPL, 250, 252f
- of B Top, 251
- of  $G_n$ , 69, 83-88, 140, 182, 250
- of  $\tilde{G}_n$ , 146, 179ff
- of  $G_n(\mathbb{C}^\infty)$ , 102, 189
- of  $P^n$ , 42, 84
- of  $P^n(\mathbb{C})$ , 159ff
- of  $P^n(\mathbb{H})$ , 243
- cohomotopy groups, 208, 233f, 236, 238f
- collar neighborhood, 200
- combinatorial Pontrjagin classes, 231-248
- complex manifold, 150f, 159
- complex analytic function, 150
- complex  $n$ -plane (or vector) bundle, 149
- complex structure  $J$ , 149, 173
- complexification  $\otimes \mathbb{C}$ , 153, 173ff
- conjugate bundle, 167, 170, 173, 176f
- connection  $\nabla$ , 289-295, 298ff, 305ff, 308, 312
  - Levi-Civita, 300-302
  - symmetric, 301
- continuous functor, 31
- coordinate neighborhood, 4
- coordinate space, 3
- coordinate system, local, 4, 19
- covariant derivative, 289, 301
- covering space, 145, 182, 312, 314
- covering homotopy, 70, 206, 252
- cross product, 92f, 105, 164, 237
- cross-section, 16ff, 22ff, 36, 39, 101f, 139, 142, 152, 289
- cup product, 38, 54, 263ff
- curvature, 31, 293-300, 306ff, 310
  - Gaussian, 303, 305
- Df, 8ff, 34, 44
- de Rham cohomology, 289, 298
- dependent cross-sections, 18
- derivative, 8ff, 34, 44
  - covariant, 289, 301
  - directional, 9
  - exterior, 292
- determinant, 295, 299, 309
- diagonal  $\Delta$ , 93, 100, 121, 123
- diagonal cohomology class, 124, 127ff
- diffeomorphism, 7, 9ff, 14, 42, 48, 115f, 151, 248, 250
- differential form, 253, 290f, 293ff, 303f
- differential operator, 9, 153, 290
- direct limit, 63, 108f, 114, 262, 277ff
- division algebra, 47ff
- dual bundle, 33, 35, 152, 168
- dual cohomology class, 120, 196, 273
- dual vector space, 9, 31, 169
- Dyer-Lashof algebra, 253
- $E_0$ , 89, 143, 157ff
- embedding, 10, 70, 81, 115, 120, 135, 148, 196, 211, 215
- Euclidean vector bundle or metric, 21ff, 28, 35f, 39, 46, 52, 89, 102, 244, 300, 309ff
- Euclidean vector space, 21
- Euler characteristic or Euler number, 15, 129f, 148, 170, 184, 186, 313f
- Euler class  $e$ , 98ff, 119f, 123f, 143-148, 155, 158, 179f, 243-247, 309, 311ff
- exponential map, 116, 124
- exterior derivative, 292
- exterior form, 295
- exterior power, 31, 70, 148

- fiber  $F_b$ , 13f
- fiber bundle, 14
- fibration, 229, 252, 256
- flat connection, 291, 294, 308, 312
- foliation, 253
- formal power series, 221, 224f
- frame, 56, 76, 139
- functor, 8, 32, 34
  - continuous, 31f
- fundamental class, cohomology, 90-92, 95, 100, 106ff, 118f, 123
  - homology, 50-52, 126f, 184, 235, 251, 270, 273
- Gauss-Bonnet theorem, 303ff, 310f
- Gauss map, 55, 60, 70
- generalized cohomology theory, 254
- generalized homology theory, 255
- geodesic coordinates, 304
- genus, K- or L-, 223f
- Girard's formula, 195
- Gram-Schmidt process, 23, 29, 57, 59
- Grassmann manifold  $G_n, G_n(\mathbb{R}^{n+k})$ , 55-65, 68-88, 102, 245, 250
  - complex  $G_n(\mathbb{C}^{n+k})$ , 102, 152, 159, 163, 171
  - oriented  $\tilde{G}_n, \tilde{G}_n(\mathbb{R}^{n+k})$ , 145, 179ff, 214f, 245f
- Gysin sequence, 143ff, 157, 160ff, 180, 243, 245, 247
- $H^\Pi$ , 39
- half space, 75ff, 199
- Hermitian metric, 156f, 161, 168
- Hirzebruch, F., 38, 219ff, 224, 231, 241
- holomorphic, 150-152
- Hom, 31, 35, 43, 45, 58, 70, 87, 169f, 248
- homology, 257-263
- homology manifold, 234-239
- homotopy class, 69
- homotopy groups, 206ff, 212ff, 245, 250f, 255, 284
- homotopy type, 223, 226, 229, 245
- Hurewicz homomorphism, 207, 246, 252
- immersion, 30f, 49f, 54, 121
- implicit function theorem, 209f
- index, 224
- index theorem, 226
- induced bundle, 25f, 149
- inner product, 21
- invariant polynomial, 295
- inverse function theorem, 5, 116
- inverse limit, 108f, 110f
- isometry, 24
- isomorphic (vector bundles), 14, 18, 35f, 38
- J-homomorphism, 284
- Jacobian  $Df_x$ , 8, 30
- jet, 24
- K-theory, 254
- Kronecker index, 50, 148, 232, 259
- Künneth theorem, 88, 128, 165, 207, 224, 268f
- $L_i, \ell_i$ , L-genus, 224ff, 231, 239ff
- Leibniz formula, 289, 292
- lens space, 245
- linear group  $GL_n, GL_n(\mathbb{R}), GL_n(\mathbb{C})$ , 14, 22, 34, 155
- local coefficients, 140
- local coordinate system, 4, 13
- local operator, 290
- local parameterization, 4, 199
- local triviality, 13, 149, 152, 249
- long line, 23
- MO(k), MSO(k), 215
- mapping cone, 112

- Mayer-Vietoris sequence, 102, 271f, 278  
 microbundle, 250  
 Moebius band, 17, 94, 120  
 multiplicative characteristic class, 227ff  
 multiplicative sequence, 219ff, 224f, 227ff  
  
 n-frame, 56, 76, 139  
 n-plane, 56, 60  
 n-plane bundle, 14, 37  
 naturality, 37  
 Newton's formula, 195  
 normal bundle, 15, 23, 29f, 41, 115ff, 121, 210, 215, 232, 252  
  
 obstruction, 139ff, 171, 251  
 oriented bundle, 95ff, 110, 155, 178f  
 oriented cobordism, 199ff, 216  
 oriented manifold, 55, 122, 185f, 200f, 234, 256, 273ff  
 oriented vector space, 95  
 oriented simplex, 95  
 orthogonal complement  $\xi^\perp$ , 28f, 35, 43, 70f, 157, 169  
 orthogonal group, 22, 253  
  
 pairing, 21  
 paracompact, 23, 28, 62, 65ff, 71, 74, 240, 291  
 parallelizable, 15, 20, 23, 47f, 148  
 parameterization, 4  
 partition, 80f, 85, 171, 183-197, 202, 216, 222  
 partition of unity, 23, 210  
 Pfaffian, 309ff  
 piecewise linear, 235, 237, 249  
 piecewise linear bundle, 249  
 piecewise linear manifold, 239, 247, 249, 252  
 Poincaré complex, 251f  
 Poincaré duality, 127ff, 131, 135, 224, 235, 239, 251, 276ff  
 Poincaré hypothesis, 247  
 Pontrjagin, L., v, 52, 186, 202  
 Pontrjagin classes  $p_i$ , 173-182, 197, 220, 223ff, 243f, 308  
     combinatorial, 231-248  
 Pontrjagin numbers, 183, 185f, 193f, 202, 217, 223f, 226, 247f, 256  
 power series, 40, 221, 224f, 281, 296  
 product formulas, 37f, 100, 164, 175, 190, 227f  
 projective module, 36  
 projective space, real  $P^n$ , 11, 15, 42ff, 49ff, 55, 70, 80, 94, 120f, 142, 144  
     complex  $P^n(\mathbb{C})$ , 133, 152, 159f, 167, 169f, 177f, 184f, 189, 192ff, 202f, 216, 225, 234  
     quaternion  $P^n(\mathbb{H})$ , 33, 186, 243, 248  
     Cayley, 134  
 quadratic function, 21  
 quaternions  $\mathbb{H}$ , 20, 48, 243, 248  
 quotient bundle, 35  
  
 $\mathbb{R}, \mathbb{R}^n, \mathbb{R}^A, \mathbb{R}^\infty, \mathbb{R}_0^n$ , 3, 62, 105, 266f, 270ff, 278f  
 $\mathbb{R}^n$ -bundle, 14, 39, 43  
     topological, 251  
 rank, 4, 85, 181, 216  
 real vector bundle, 13  
 refinement, 183, 195  
 regular value, 208ff, 217, 232, 241  
 representation ring, 256  
 restriction, 25, 270  
 Riemann surface, 312  
 Riemannian connection, 302  
 Riemannian manifold or metric, 22, 29f, 35, 115, 121, 253ff, 300ff  
 ring of smooth functions  $C^\infty(M, \mathbb{R})$ , 10f

- Sard's theorem, 209, 232  
 Schubert cell, Schubert variety, 75  
     171  
 Schubert symbol  $\sigma$ , 75-80  
 second fundamental form, 35, 70  
 Serre, J.-P., 207, 233  
 signature  $\sigma$ , 224, 232f, 235ff, 247  
 signature theorem, 224ff  
 sign conventions, 258, 304  
 simplicial complex, 234, 237ff, 249  
 simplicial map, 235ff  
 simplex  $\Delta^n$ , 95f, 234ff, 257  
 singular homology and cohomology,  
     37, 258  
 skeleton, 260  
 slant product, 125f, 131  
 smooth function, 4, 7, 34, 70  
 smooth manifold, 3, 4, 9f, 12, 25,  
     53, 70, 139  
     with boundary, 52, 186, 199ff,  
         255, 279f  
 smooth path, 5  
 smooth vector bundle, 14f, 26, 34,  
     243  
 smoothness structure, 10f, 248,  
     250  
 sphere bundle, 38  
 spinor group, 253  
 stable homotopy group, 255  
 Steenrod reduced powers, 228  
 Steenrod squares, 90ff, 130ff, 182  
 Stiefel, E., v, 38, 47f  
 Stiefel manifold, 56, 68f, 139,  
     145, 171  
 Stiefel-Whitney class  $w_i$ , 37-50,  
     54, 83, 119ff, 130ff, 140, 171,  
     181  
     axioms, 37f, 92  
     dual, 49, 87, 136  
     existence, 89-94  
     total, 39f  
     uniqueness, 86f  
 Stiefel-Whitney number, 50ff, 81,  
     130, 136, 197, 217, 256  
 Stokes theorem, 304  
 structural group, 14, 22, 34, 253,  
     294, 312  
 sub-bundle, 27f, 54, 103  
 sub-division, 235, 237  
 submanifold, 29f  
 submersion, 35  
 symmetric function, 84, 87,  
     186-191, 222, 230, 299  
 symplectic group, 253  
 tangent bundle  $\tau$ , 14, 21f, 25, 27,  
     29f, 41ff, 70, 87, 121f, 199f,  
     243, 251, 249ff  
     complex, 151, 169, 289  
 tangent manifold DM, 7ff, 44  
 tangent space  $DM_x$ , 3, 5, 7ff, 30,  
     200, 209f  
 tangent vector, 5, 9f  
 tensor product  $\otimes$ , 31-36, 87, 149,  
     173, 289  
 Thom, R., 53, 91, 193f, 199ff,  
     224, 231  
 Thom isomorphism, 90ff, 97, 99,  
     105ff, 119, 207  
 Thom space, 205-208, 211ff, 252  
 Todd genus, 229  
 topological manifold, 57, 251  
 topology, direct limit, 63f, 74  
     fine = large = Whitehead, 63, 74  
     weak, 63  
 total differential, 9  
 total space  $E(\xi)$ , 13, 115, 243  
 trace, 295, 306  
 transversality, 205, 208-215  
 triangulation, 139, 143, 240, 247,  
     251  
 trivial bundle  $\varepsilon^n$ , 13ff, 18ff, 22,  
     38f, 45  
 tubular neighborhood, 115, 125,  
     136, 215

- underlying real bundle  $\omega_{\mathbb{R}}$ , 150, 168, 173, 176, 221
- unitary group, 253
- universal bundle, 61, 65 (see canonical)
  - oriented, 145, 214ff
  - complex, 163
- vector bundle, 13ff
  - complex, 149-154, 289
  - dual, 33, 35
  - Euclidean, 21
  - smooth, 14, 34
- vector field, 16, 23, 54, 139, 142, 148
- vector space, 3, 9, 13, 31f, 95
  - dual, 31, 169
- velocity vector, 5
- Whitehead theorems, 208, 240
- Whitney, H., v, 38, 50
- Whitney duality theorem, 39-41, 49, 120, 220
- Whitney product theorem, 37ff, 46
- Whitney sum, 27-31, 45, 100, 149, 164, 175, 189f, 307
- Wu class, 132, 228f
- Wu formulas, 94, 130ff, 148

LIBRARY OF CONGRESS CATALOGING IN PUBLICATION DATA

Milnor, John Willard, 1931-

Characteristic classes.

(Annals of mathematics studies, no. 76)

Bibliography: p.

1. Characteristic classes. I. Stasheff, James,  
joint author. II. Title. III. Series.

QA613.618.M54 514'.7 72-4050

ISBN 0-691-08122-0